



LIGHTING &
WIRING ACCESSORIES

Knightsbridge

AWARD-WINNING CUSTOMER SERVICE



QUOTES WITHIN
1 HOUR



SAME DAY COLLECTION
FROM OUR WAREHOUSE



5PM CUT OFF NEXT DAY
DELIVERY (MON-THU)
(3PM ON FRIDAYS)



DELIVER DIRECT TO
YOUR CUSTOMERS
WITH K-DIRECT

ONLINE FEATURES



LIVE CHAT



LIVE STOCK
AVAILABILITY



MANAGE AND
TRACK ORDERS



CSV PRODUCT
DATA DOWNLOAD

ABOUT US



ESTABLISHED IN 1998



3000+ PRODUCTS
IN STOCK



AVAILABLE AT ALL
MAJOR WHOLESALERS



COMMITTED TO A
BRIGHTER FUTURE

OFFICE HOURS:

Mon-Thu: 8am to 5.30pm
Fri: 8am to 5pm
Closed on weekends

Tel: 01582 88 77 60

Enquiries: sales@mlaccessories.co.uk

Orders: orders@mlaccessories.co.uk

www.mlaccessories.co.uk

A black cylindrical outdoor spotlight is the central focus, emitting a warm, golden light from its lens. It is positioned in a garden bed filled with white pebbles. In the background, there are green ferns and a stone wall, creating a serene outdoor setting.

>Knightsbridge

CUSTOMER GUARANTEE

Our aim is to deliver quality products and service in a highly professional manner at all times. We are totally committed to our customers and will endeavour to operate with honesty and integrity, trading fairly throughout our success and continuous improvement...

...and that's a promise!



CONTENTS

WIRING ACCESSORIES

Moulded Switches & Sockets

Square Edge	4 - 13
Curved Edge	14 - 27

Metal Decorative Switches & Sockets

Rounded Edge	28 - 43
Square Edge	44 - 61
Flat Plate	62 - 87
Screwless	88 - 133

Specialist Sockets

134 - 141

Metal Clad Switches & Sockets

142 - 151

Datacomms

152 - 161

Grid Wiring Accessories

162 - 163

Weatherproof

164 - 175

Wiring Basics

176 - 187

Industrial Switches & Sockets

188 - 189

Wireless Door Chimes

190 - 191

Ventilation

192 - 193

Sensors

194 - 199

SMART HOME

200 - 215

LIGHTING

Domestic Interior

Downlights	216 - 245
Ceiling & Wall Lights	246 - 263
Bathroom	264 - 283
Under Cabinet	284 - 295

LED Flex

296 - 305

Outdoor Lighting

Wall Lights	306 - 331
Bollard Lighting	332 - 335
Spike Lights	336 - 343
Groundlights & Deck Lighting	344 - 355
Floodlights	356 - 365
Outdoor Heating	366 - 367

Commercial Lighting

Bulkheads & Wall Packs	368 - 383
Commercial Downlights	384 - 391
Recessed, Surface & Suspension Lighting	392 - 399
Battens	400 - 411
Non-Corrosive	412 - 419
High Bay / Low Bay	420 - 423

Emergency Lighting

424 - 439

Lamps & Lighting Accessories

440 - 453

INDEX

454 - 484



MOULDED SWITCHES & SOCKETS

SQUARE EDGE

Comprehensive, all-purpose moulded switches and sockets

13A 2G Sockets	8
13A 2G USB Sockets / Phone Holder	9
13A 1G Sockets / Fan Isolator Switch / Shaver Socket	10
10AX Switches / Dimmers / Round Pin Socket	11
Fused Spur Units / 20A Switches / 45A Cooker Switches and Sockets	12
Media Outlets / Blanking Plates / Modular Frames / Pattress Boxes / Screws	13



LASER PRINTING

All markings (where required) are applied with modern laser printing

DOUBLE POLE SWITCHES

On selected products for additional safety



ANTI-MICROBIAL

SCREW CAP COVERS

Included as standard, for a clean, un tarnished look

LOW PROFILE DESIGN

Projection of just 9mm (including gasket)

TOP-DOWN TERMINATION

L, N and E can all be terminated from the top – ideal when installing multiple outlets

CAPTIVE TERMINALS

Appropriate terminal capacities and captive terminals to prevent screws falling out

HIGH INTEGRITY EARTHING

Twin earth terminals where appropriate

15 YEAR WARRANTY*

*2 years on electronic products

DIMENSIONS*

Single plate: 86mm x 86mm
Double plate: 86mm x 146mm
Projection: 9mm

*Unless otherwise stated

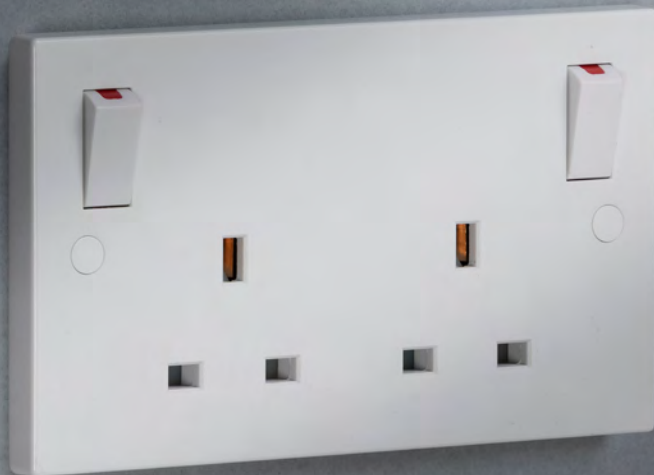

NEW OUTBOARD ROCKER DESIGN

OUTBOARD ROCKERS

Ordinarily used to prevent inadvertently switching the wrong side off; ideal for the elderly





13A 2G SWITCHED SOCKETS WITH USB

- Minimum mounting box depth: 25-35mm (dependent on wiring conditions)

Code	Model
SN9904	Switched Socket with Dual USB Charger + Twin Earth
SN9002	Outboard Rockers + Dual USB Charger (A+C) NEW



13A 2G SWITCHED SOCKETS

- Minimum mounting box depth: 25mm

Code	Model
SN9000*	Double Pole + Twin Earth
SN9000S*	Single Pole + Twin Earth
SN9000U	Unswitched + Twin Earth
SN9KW	Smart Wi-Fi + Twin Earth <small>Works with Alexa and Hey Google See page 205</small>
SN9001	Double Pole + Outboard Rockers + Twin Earth NEW



*ASTA Diamond certified products: SN9000, SN9000S

Amazon, Alexa and all related logos are trademarks of Amazon.com, Inc. or its affiliates.

Google and Android are trademarks of Google LLC



FLIP-DOWN PHONE HOLDER

- Flip-down phone holder for use with double switched sockets with USB charging facility
- Two-piece install - no need to remove socket from wall
- Sits behind the existing double switched socket
- Fold down shelf for supporting your device whilst charging - folds up when not in use

Code	Size	Model
2GPHW	2G	White



13A 2G SWITCHED SOCKET WITH FASTCHARGE USB

- FASTCHARGE USB-C port compatible with QC2.0/QC3.0 and USB-PD
- FASTCHARGE USB-A port compatible with QC2.0/QC3.0
- Capable of delivering 0-50% charge in under 30 mins with compatible phones
- 80% faster than a standard 5V DC 2A charger
- Compatible with Android™ based devices supporting QC2.0/QC3.0 and USB-PD (via USB-C port only)
- Compatible with Apple devices supporting USB-PD (iPhone 8 and above, require certified Lightning to USB-C charge/sync cable)

Code	Model
SN9909	FASTCHARGE USB Charger (A+C) NEW

13A SWITCHED SOCKET WITH QUAD USB CHARGER

- Minimum mounting box depth: 25-35mm (dependent on wiring conditions)
- Built-in Quad USB Charger 5V DC 5.1A
- Dedicated 2.1A outlet
- 3A shared over 3 outlets

Code	Model
ST7USB4	Quad USB Charger Socket



BROWSE OUR NEW RANGE OF USB CERTIFIED CABLES ON

PAGE 158



13A 1G SWITCHED SOCKETS

- Minimum mounting box depth: 25mm

Code	Model
SN7000*	Double Pole
SN7000S*	Single Pole
SN7000U	Unswitched
SN9903	Switched Socket with USB Charger



*ASTA Diamond certified products:
SN7000, SN7000S



DUAL VOLTAGE SHAVER SOCKET

- Minimum mounting box depth: 47mm

Code	Model
SN8900N	115/230V 20VA Rated + Neon



10AX FAN ISOLATOR SWITCH

- Minimum mounting box depth: 16mm

Code	Model
SN1100	Triple Pole

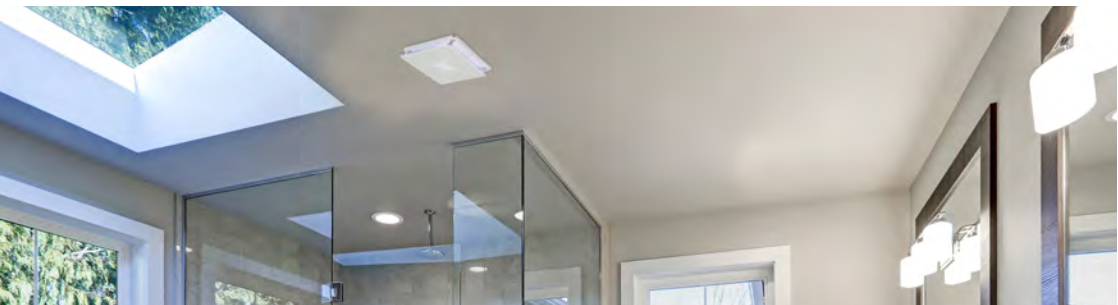

MIX AND MATCH



page 192



page 182

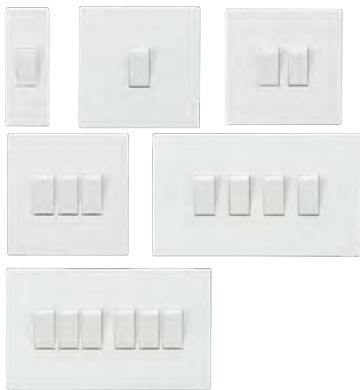

10AX SWITCHES

- Minimum mounting box depth: 16mm

Code	Size	Model
SN127		2-Way (Architrave)
SN1200	1G	Intermediate
SN1000	1G	1-Way
SN2000	1G	2-Way
SN3000	2G	2-Way
SN4000	3G	2-Way
SN4100	4G	2-Way
SN4200	6G	2-Way



ROUND PIN SOCKET

- Minimum mounting box depth: 25mm
- 5A rated

Code	Model
SN5U	Unswitched



LEADING-EDGE DIMMERS

- 40-400W incandescent (unless otherwise stated)
- 3-100W LED (unless otherwise stated)
- Minimum mounting box depth: 35mm

Code	Size	Model
SN2161	1G	2-Way
SN2165	1G	60-1000W Incandescent
SN2162	2G	2-Way
SN2163	3G	2-Way
SN2164	4G	2-Way
SN1DIM	1G	Plate and Cap Only
SN2DIM	2G	Plate and Caps Only
SN400M		40-400W (3-100W LED) Leading-Edge Module

VFR200M 10-200W (5-150W LED)
Trailing-Edge Module

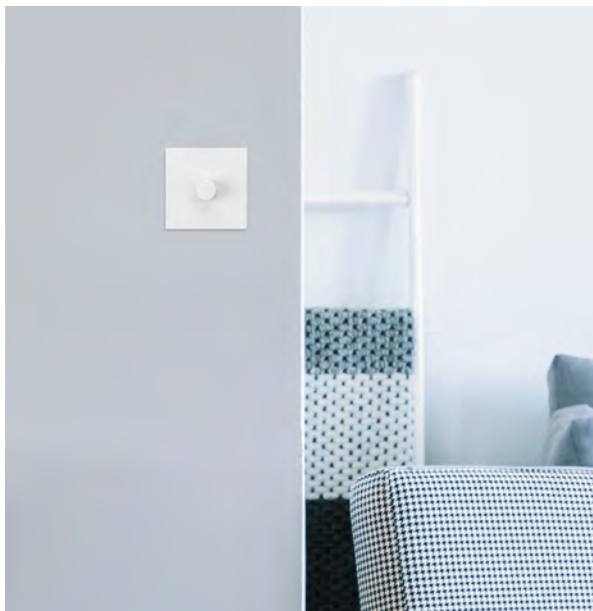



45A COOKER SWITCH AND SOCKET

- Double pole switch
- 13A switched socket
- Minimum mounting box depth: 47mm

Code	Model
SN8333	Switched
SN8333N	Switched + Neon
SN8333W	Switched (White Rocker)
SN8333NW	Switched + Neon (White Rocker)



FUSED SPUR UNITS

- Double pole switches (where applicable)
- Minimum mounting box depth: 25mm
- Flex outlet from base

Code	Model
SN6000	Unswitched
SN6000-3A	Unswitched (3A Rated)
SN6000N	Unswitched + Neon
SN6300	Switched
SN6300N	Switched + Neon



45A COOKER SWITCHES

- Double pole switches
- Minimum mounting box depth: 47mm

Code	Size	Model
SN8331	Single	Switched
SN8331N	Single	Switched + Neon
SN8331W	Single	Switched (White Rocker)
SN8331NW	Single	Switched + Neon (White Rocker)
SN8340	Single	Cooker Connection Unit
SN8332	Double	Switched
SN8332N	Double	Switched + Neon
SN8332W	Double	Switched (White Rocker)
SN8332NW	Double	Switched + Neon (White Rocker)



20A SWITCHES

- Double pole switches (where applicable)
- Minimum mounting box depth: 25mm

Code	Model
SN8341	Switched
SN8341N	Switched + Neon
SN8342	Flex Outlet Plate (From Base or Centre)

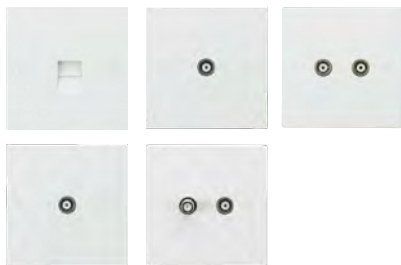

MEDIA OUTLETS

- Minimum mounting box depth: 25mm

Code	Model
SN7300	Telephone Socket - Master
SN7400	Telephone Socket - Extension
SN0100	Single TV Outlet - Non-Isolated
SN0110	Twin TV Outlet - Non-Isolated
SN0120	Single TV Outlet - Isolated
SN0140	TV and SAT TV Outlet - Non-Isolated



BLANKING PLATES

Code	Model
SN8350	1G
SN8360	2G



MODULAR FRAMES

- For use with 25mm x 50mm or 50mm x 50mm euro modules

Code	Model
NET1GWH	1 Module
NET2GWH	1 - 2 Modules
NET4GWH	2 - 4 Modules

Modular inserts available on page 155



PATRRESS BOXES

Code	Size	Model	Qty
SN1300	Single	16mm + Earth Terminal	10
SN1400	Single	25mm	10
SN1700	Single	35mm + Earth Terminal	10
SN1610	Single	47mm + Earth Terminal and Cable Clamp	10
SN127P		16mm + Earth Terminal (Architrave)	10
SN1500	Double	25mm	5
SN1600	Double	47mm + Earth Terminal and Cable Clamp	5
SN1800	Double	35mm + Earth Terminal	5
SN1510	Double	35mm Dual + Earth Terminals	5



ELECTRICAL SCREWS

- M3.5 - Raised head - countersunk

Code	Model	Qty
CSCREW35	35mm	100
CSCREW50	50mm	100
CSCREW75	75mm	100

Code	Model	Qty
CAPCOVERS	Screw Cap Covers	100







MOULDED SWITCHES & SOCKETS

CURVED EDGE

White moulded switches and sockets with gently contoured 7mm plates and soft edges

13A 2G Sockets / RCD Socket	18
13A 2G USB Sockets (inc. FASTCHARGE) / Phone Holder	19
13A 1G Sockets / Fan Isolator Switch / Shaver Socket	20
10AX Switches / Dimmers / Round Pin Socket	21
Fused Spur Units	22
20A Switches / 45A Cooker Switches and Sockets	23
Multimedia Combination Plates	24
Media Outlets / Blanking Plates / Modular Frames / Pattress Boxes / Screws	25
Grid Wiring Accessories	26 - 27

DOUBLE POLE SWITCHES

On selected products for additional safety

LASER PRINTING

All markings (where required) are applied with modern laser printing



ANTI-MICROBIAL

SCREW CAP COVERS

Included as standard, for a clean, untarnished look

LOW PROFILE DESIGN

Projection of just 9mm (including gasket)

TOP-DOWN TERMINATION

L, N and E can all be terminated from the top – ideal when installing multiple outlets

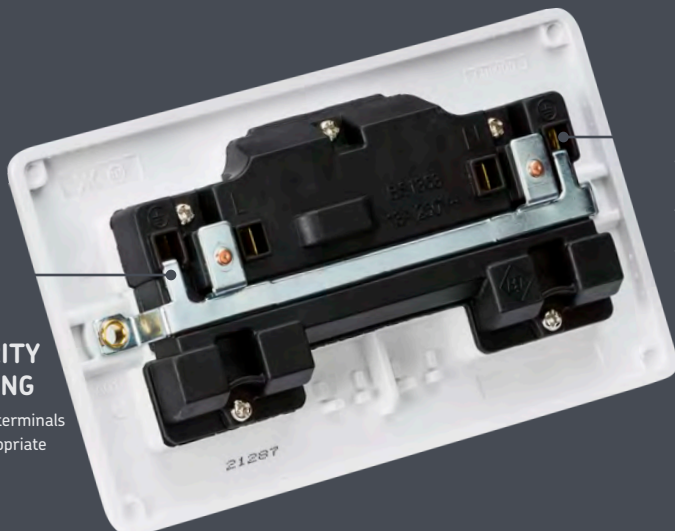

CAPTIVE TERMINALS

Appropriate terminal capacities and captive terminals to prevent screws falling out

HIGH INTEGRITY EARTHING

Twin earth terminals where appropriate

15 YEAR WARRANTY*

*2 years on electronic products

DIMENSIONS*

Single plate: 86mm x 86mm
Double plate: 86mm x 146mm
Projection: 7mm

*Unless otherwise stated

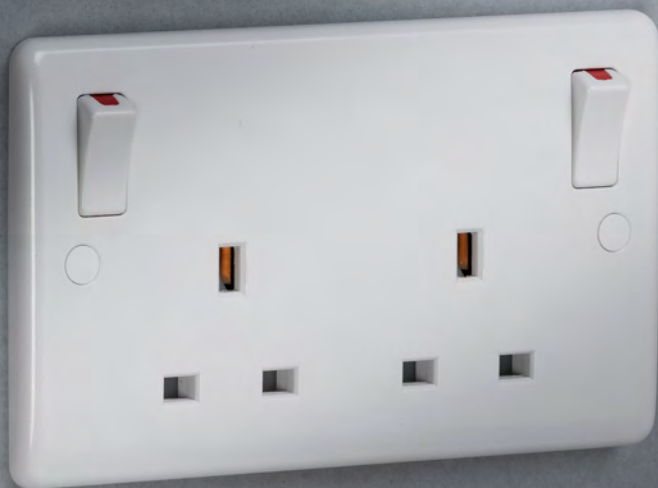

NEW OUTBOARD ROCKER DESIGN

OUTBOARD ROCKERS

Ordinarily used to prevent inadvertently switching the wrong side off; ideal for the elderly





NOW AVAILABLE
WITH OUTBOARD
ROCKERS



13A 2G SWITCHED SOCKETS

- Minimum mounting box depth: 25mm

Code	Model
CU9000*	DP + Twin Earth
CU9000S*	SP + Twin Earth
CU9000U	Unswitched + Twin Earth
CU9001	DP + Twin Earth (Outboard Rockers) NEW
CU9KW	Smart Wi-Fi + Twin Earth Works with Alexa and Hey Google. See page 205

13A 2G DP RCD SWITCHED SOCKET

Type A RCD for AC residual current and pulsating DC up to 6 mA. Suitable for equipment with electronic components like IT equipment.

Passive (latching) type, which will automatically reset after a power outage, without the need for manual resetting.

- Tripping current (I_{Δn}): 30mA
- Trip time @ I_{Δn}: 40ms
- Outboard rockers
- Minimum mounting box depth: 35mm

Code	Model
CU9RCD	DP RCD Switched Socket - 30mA (Type-A) NEW



Amazon, Alexa and all related logos are trademarks of Amazon.com, Inc. or its affiliates.



Google is a trademark of Google LLC.



*ASTA Diamond certified products:
CU9000, CU9000S



13A 2G SWITCHED SOCKETS WITH FASTCHARGE USB

- FASTCHARGE USB-C port compatible with QC2.0/QC3.0 and USB-PD
- FASTCHARGE USB-A port compatible with QC2.0/QC3.0
- Capable of delivering 0-50% charge in under 30 mins with compatible phones
- 80% faster than a standard 5V DC 2A charger
- Compatible with Android™ based devices supporting QC2.0/QC3.0 and USB-PD (via USB-C port only)
- Compatible with Apple devices supporting USB-PD (iPhone 8 and above, require certified Lightning to USB-C charge/sync cable)

Code	Model	USB Config	
CU9909	DP Switched Socket	A+C (FASTCHARGE)	NEW

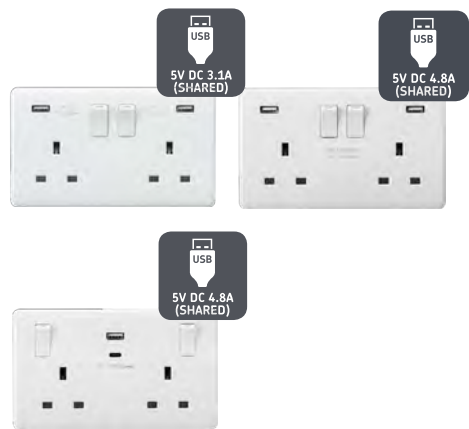
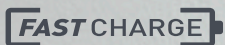

FLIP-DOWN PHONE HOLDER

- Flip-down phone holder for use with double switched sockets with USB charging facility
- Two-piece install - no need to remove socket from wall
- Sits behind the existing double switched socket
- Fold down shelf for supporting your device whilst charging - folds up when not in use

Code	Size	Model
2GPHW	2G	White

13A 2G SWITCHED SOCKETS WITH USB

- Minimum mounting box depth: 25mm (dependant on wiring conditions)

Code	Model	USB Config	
CU9904	SP + Dual USB	A+A (3.1A)	
CU9948	DP + Dual USB	A+A (4.8A)	
CU9002	SP + Dual USB	A+C (4.8A)	NEW



BROWSE OUR NEW RANGE OF USB CERTIFIED CABLES ON

PAGE 158



13A 1G SWITCHED SOCKETS

- Minimum mounting box depth: 25mm

Code	Model
CU7000*	Double Pole
CU7000S*	Single Pole
CU7000U	Unswitched
CU9903	Switched Socket with USB Charger



***ASTA Diamond certified products:**
CU7000, CU7000S

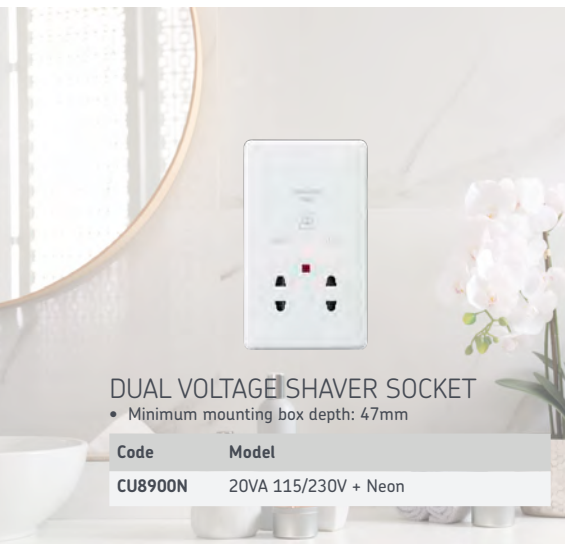

DUAL VOLTAGE SHAVER SOCKET

- Minimum mounting box depth: 47mm

Code	Model
CU8900N	20VA 115/230V + Neon



10AX FAN ISOLATOR SWITCH

- Minimum mounting box depth: 16mm

Code	Model
CU1100	Triple Pole



MIX AND MATCH



page 192



page 182



CU1200M - can be attached to any Curved Edge switch plate to make an intermediate switch



10AX SWITCHES

- Minimum mounting box depth: 16mm (unless otherwise specified)

Code	Size	Model
CU1200	1G	Intermediate
CU1200M		Intermediate Module *Not Suitable For Use with CU4101
CU1000	1G	1-Way
CU2000	1G	2-Way
CU3000	2G	2-Way
CU4000	3G	2-Way
CU4101	4G	2-Way (Single Plate) Min. Mounting Depth: 25mm
CU4100	4G	2-Way
CU4200	6G	2-Way



ROUND PIN SOCKET

- 5A rated
- Minimum mounting box depth: 25mm

Code	Model
CU5U	Unswitched

LEADING-EDGE DIMMERS

- 40-400W incandescent | 3-100W LED (unless otherwise specified)
- Minimum mounting box depth: 25mm

Code	Size	Model
CU2161	1G	2-Way
CU2162	2G	2-Way
CU1DIM	1G	Plate and Cap Only
CU2DIM	2G	Plate and Cap Only
CU2163	3G	2-Way
CU2164	4G	2-Way
SN400M		40-400W (3-100W LED) Leading-Edge Module
VFR200M		10-200W (5-150W LED) Trailing-Edge Module





FUSED SPUR UNITS

- Minimum mounting box depth: 25mm
- 13A rated
- Double pole switches (where applicable)

Code	Model
CU6000	Unswitched
CU6000-3A	Unswitched (3A Fused)
CU6000N	Unswitched + Neon
CU6300	Switched
CU6300N	Switched + Neon
CU6300F	Switched + Flex Outlet From Base (10mm Plate)

RCD FUSED SPUR UNIT

Type A RCD for AC residual current and pulsating DC up to 6 mA. Suitable for equipment with electronic components like IT equipment.

- 13A rated
- Will automatically reset after a power outage, without the need for manual resetting
- Tripping current ($I_{\Delta n}$): 30mA
- Trip time @ $I_{\Delta n}$: 40ms
- Minimum mounting box depth: 35mm

Code	Model
CU6RCD	RCD 30mA (Type-A) NEW



20A SWITCHES

- Double pole switches (where applicable)
- Minimum mounting box depth: 25mm

Code	Model
CU8341	Switched
CU8341N	Switched + Neon
CU8342	Flex Outlet Plate (From Base or Centre)



45A COOKER SWITCHES

- Double pole switches
- Minimum mounting box depth: 47mm

Code	Size	Model
CU8331	Single	Switched
CU8331W	Single	Switched (White Rocker)
CU8331N	Single	Switched + Neon
CU8331NW	Single	Switched + Neon (White Rocker)
CU8332	Double	Switched
CU8332W	Double	Switched (White Rocker)
CU8332N	Double	Switched + Neon
CU8332NW	Double	Switched + Neon (White Rocker)
CU8340	Single	Cooker Connection Unit

45A COOKER SWITCHES AND SOCKETS

- Double pole switches
- 13A switched socket
- Minimum mounting box depth: 47mm

Code	Model
CU8333	Switched
CU8333W	Switched + Neon (White Rocker)
CU8333N	Switched
CU8333NW	Switched + Neon (White Rocker)



Essential for any major upgrade, renovation, or new build. The Curved Edge multimedia combination plate allows for a power and bespoke signal distribution solution to be combined in one area.

Compatible with our extensive range of modular inserts, this plate can be configured to suit your requirements, be it satellite, TV, DAB, telecoms, networking, or even USB charging.

13A LARGE MULTIMEDIA COMBINATION PLATE

- Double pole switches
- 2 x 2G double sockets with twin earth
- Space for up to 8 x euro module inserts (25mm x 50mm)
- Dimensions: (h) 175mm x (w) 295mm x (p) 7mm
- Minimum mounting box depth: 47mm



*Modular inserts not included

Code	Model
CU298MM	Large Multimedia Plate
GSK298MM	Back Box (Large Multimedia Plate)



13A SMALL MULTIMEDIA COMBINATION PLATE

- Double pole switches
- 1 x 2G double socket with twin earth
- Space for up to 4 x euro module inserts (25 x 50mm)
- Dimensions: (H) 175mm x (W) 148mm x (P) 7mm
- Minimum mounting box depth: 47mm



*Modular inserts not included

Code	Model
CU194MM	Small Multimedia Plate NEW
GSK194MM	Back Box (Small Multimedia Plate)

Modular inserts available on page 155



MEDIA OUTLETS

- Minimum mounting box depth: 25mm

Code	Model
CU7300	Telephone Socket - Master
CU7400	Telephone Socket - Extension
CU0100	Single TV Outlet - Non-Isolated
CU0110	Twin TV Outlet - Non-Isolated
CU0120	Single TV Outlet - Isolated
CU0150	SAT TV Outlet - Non-Isolated
CU0140	TV and SAT TV Outlet - Non-Isolated



BLANKING PLATES

Code	Model
CU8350	1G
CU8360	2G



MODULAR FRAMES

Code	Model
CU1G	1 Module
CU2G	1 - 2 Modules
CU4G	2 - 4 Modules

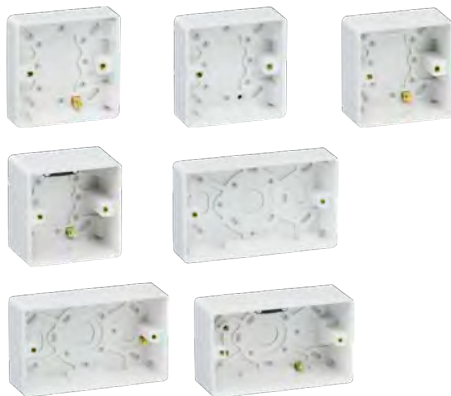

PATRESS BOXES

Code	Size	Model	Qty
CU1300	Single	16mm + Earth Terminal	10
CU1400	Single	25mm	10
CU1700	Single	35mm + Earth Terminal	10
CU1610	Single	47mm + Earth Terminal and Cable Clamp	10
CU1500	Double	25mm	5
CU1800	Double	35mm + Earth Terminal	5
CU1600	Double	47mm + Earth Terminal and Cable Clamp	5



ELECTRICAL SCREWS

- M3.5 - Raised head - countersunk

Code	Model	Qty
CSCREW35	35mm	100
CSCREW50	50mm	100
CSCREW75	75mm	100



Modular inserts available on page 155

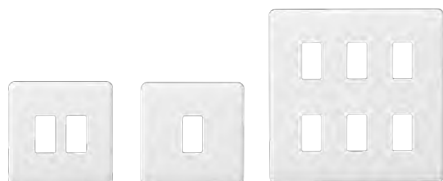

GRID FACEPLATES

- Requires grid mounting frame (sold separately)
- For use with Curved grid accessories only

Code	Model
CUG1	1G
CUG2	2G
CUG3	3G
CUG4	4G
CUG6	6G
CUG8	8G
CUG12	12G

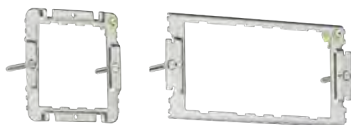

GRID MOUNTING FRAMES

Code	Model
CUG1F	1-2G
CUG2F	3-4G



CUGM23
Perfect for
blinds!

20AX GRID SWITCH MODULES

Code	Model
CUGM1	1-Way SP
CUGM2	2-Way SP
CUGM3	2-Way SP (Centre-Off)
CUGM4	Intermediate
CUGM5	2-Way SP Retractive (Marked "PRESS")
CUGM6	DP
CUGM23	2-Way Retractive (Centre-Off) NEW



**GRID BACK
BOXES**
Page 178



20AX GRID KEY SWITCH MODULES

- Supplied with test key

Code	Model
CUGM7	2-Way SP
CUGM8	DP
CUGM9	2-Way SP (Marked "EMG LTG TEST")
CUGM10	DP (Marked "EMG LTG TEST")
GDKEY	Spare Key



MISCELLANEOUS GRID MODULES

Code	Model
CUGM15	Fuse Holder (13A)
CUGM16	Flex Outlet (Max. 10mm)
CUGM17	Blank
CUGM13	Indicator - Red
CUGM12	Indicator - Orange
CUGM11	Indicator - Green



LEADING-EDGE GRID 2-WAY DIMMER

- 40-400W incandescent | 5-100W LED
- Operation: Press on/off - Rotary action dim up/down

Code	Model
CUGM14	40-400W (5-100W LED) Leading-Edge Dimmer



GRID ROCKER COVERS

- Replace an existing rocker with a laser printed version indicating the appliance it refers to

Code	Model
CUBOIL	Boiler
CUCOFF	Coffee Machine NEW
CUHOOD	Cooker Hood
CUDISH	Dishwasher
CUFAN	Fan
CUBOOST	Fan Boost NEW
CUFREEZER	Freezer NEW
CUFRIDGE	Fridge NEW
CUFRID	Fridge Freezer
CUHOB	Hob
CUMICRO	Microwave
CUOVEN	Oven
CUDRY	Tumble Dryer
CUWARM	Warming Drawer NEW
CUWASH	Washine Machine
CUWASTE	Waste Disposal NEW
CUWINE	Wine Cooler NEW





METAL DECORATIVE SWITCHES & SOCKETS

ROUNDED EDGE

Metal decorative switches and sockets with a contemporary rounded edge design

13A 2G Sockets / 13A 2G USB Sockets	32
13A 1G Sockets / 13A 1G USB Sockets / Phone Holder	33
Fan Isolator Switches / Shaver Sockets / Round Pin Sockets	34
10AX Switches	35
10AX Toggle Switches / Dimmers	36
Fused Spur Units / 20A Switches	37
45A Cooker Switches and Sockets	38
Media Outlets	39
Blanking Plates / Modular Frames	40
Grid Wiring Accessories	41 - 43

COLOUR MATCHING

Matching metal rockers with no surround

DOUBLE POLE SWITCHES

On selected products for additional safety

LONG LASTING

Robust full metal housing

UNIQUE SOCKET DESIGN

Socket completely concealed by plug once inserted

ROUND EDGE DESIGN

Projection of 7.5mm (including gasket)

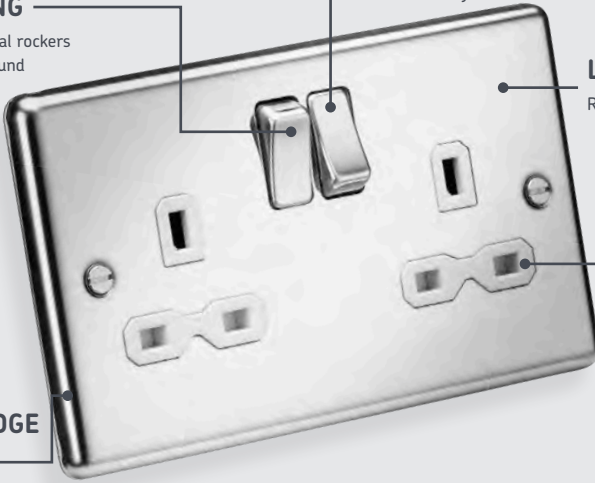

CAPTIVE TERMINALS

Appropriate terminal capacities and captive terminals to prevent screws falling out

INTEGRATED MOISTURE GASKET

Prevents any moisture transfer to decorative front plate

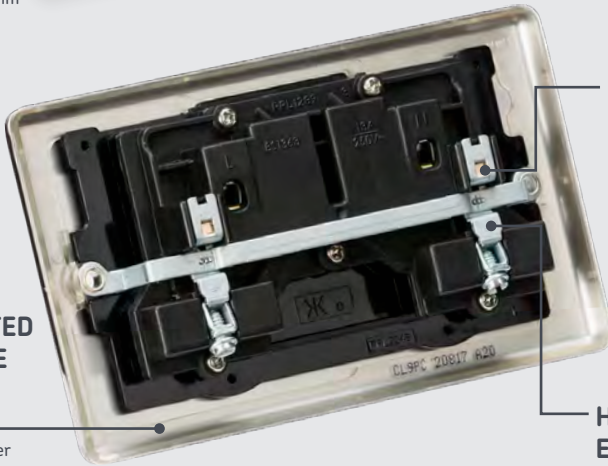

HIGH INTEGRITY EARTHING

Twin earth terminals where appropriate

15 YEAR WARRANTY*

*2 years on electronic products

DIMENSIONS*

Single plate: 86mm x 86mm
Double plate: 146mm x 146mm
Projection: 7.5mm

*Unless otherwise stated



Only high-quality imported US ICs and USB Controllers are used in this range, ensuring trouble-free charging and longevity for hospitality areas



Brushed Chrome | Metal style

INSERT OPTIONS



Polished Chrome | Mirror style

INSERT OPTIONS



FINISH OPTIONS



13A 2G DP SWITCHED SOCKETS

- Minimum mounting box depth: 25mm



Code	Finish	Insert
CL9BC	Brushed Chrome	Black
CL9BCG	Brushed Chrome	Grey
CL9BCW	Brushed Chrome	White
CL9PC	Polished Chrome	Black
CL9PCG	Polished Chrome	Grey
CL9PCW	Polished Chrome	White

13A 2G SWITCHED SOCKETS WITH USB

- Minimum mounting box depth: 25mm-35mm (dependent on wiring conditions)



Code	Finish	Insert
CL9224BC	Brushed Chrome	Black
CL9224BCG	Brushed Chrome	Grey
CL9224BCW	Brushed Chrome	White
CL9224PC	Polished Chrome	Black
CL9224PCG	Polished Chrome	Grey
CL9224PCW	Polished Chrome	White

FLIP-DOWN PHONE HOLDER

- Handy flip-down phone holder for use with double switched sockets with USB charging facility
- Two-piece install - no need to remove socket from wall
- Sits behind the existing double switched socket
- Fold down shelf for supporting your device whilst charging - folds up when not in use



Code	Finish
2GPHBK	Black
2GPHGY	Grey
2GPHW	White

13A 1G DP SWITCHED SOCKETS

- Minimum mounting box depth: 25mm



Code	Finish	Insert
CL7BC	Brushed Chrome	Black
CL7BCG	Brushed Chrome	Grey
CL7BCW	Brushed Chrome	White
CL7PC	Polished Chrome	Black
CL7PCG	Polished Chrome	Grey
CL7PCW	Polished Chrome	White

13A 1G SWITCHED SOCKETS WITH USB

- Minimum mounting box depth: 25mm-35mm (dependent on wiring conditions)



Code	Finish	Insert
CL9124BC	Brushed Chrome	Black NEW
CL9124BCG	Brushed Chrome	Grey NEW
CL9124BCW	Brushed Chrome	White NEW
CL9124PC	Polished Chrome	Black NEW
CL9124PCG	Polished Chrome	Grey NEW
CL9124PCW	Polished Chrome	White NEW



DUAL VOLTAGE SHAVER SOCKETS

- IP41 rated
- 115/230V 20VA rated
- Minimum mounting box depth: 47mm



Code	Finish	Insert
CL89BC	Brushed Chrome	Black
CL89BCG	Brushed Chrome	Grey
CL89BCW	Brushed Chrome	White
CL89PC	Polished Chrome	Black
CL89PCG	Polished Chrome	Grey
CL89PCW	Polished Chrome	White

ROUND PIN SOCKETS

- 5A rated
- Minimum mounting box depth: 25mm



Code	Finish	Insert
CL5ABC	Brushed Chrome	Black
CL5ABCG	Brushed Chrome	Grey
CL5ABCW	Brushed Chrome	White
CL5APC	Polished Chrome	Black
CL5APCG	Polished Chrome	Grey
CL5APCW	Polished Chrome	White

10AX FAN ISOLATOR SWITCHES

- Minimum mounting box depth: 16mm
- Triple pole



Code	Finish
CL11BC	Brushed Chrome
CL11PC	Polished Chrome

GRID FAN
ISOLATOR
MODULES
PAGE 42



10AX SWITCHES

- Minimum mounting box depth: 16mm



Code	Size	Model	Finish
CL12BC	1G	Intermediate	Brushed Chrome
CL12PC	1G	Intermediate	Polished Chrome
CL2BC	1G	2-Way	Brushed Chrome
CL2PC	1G	2-Way	Polished Chrome



Code	Size	Model	Finish
CL41BC	4G	2-Way	Brushed Chrome
CL41PC	4G	2-Way	Polished Chrome



Code	Size	Model	Finish
CL3BC	2G	2-Way	Brushed Chrome
CL3PC	2G	2-Way	Polished Chrome



Code	Size	Model	Finish
CL42BC	6G	2-Way	Brushed Chrome
CL42PC	6G	2-Way	Polished Chrome



Code	Size	Model	Finish
CL4BC	3G	2-Way	Brushed Chrome
CL4PC	3G	2-Way	Polished Chrome





10AX TOGGLE SWITCHES

- Minimum mounting box depth: 16mm



Code	Size	Model	Finish
CLTOG12BC	1G	Intermediate	Brushed Chrome
CLTOG12PC	1G	Intermediate	Polished Chrome
CLTOG1BC	1G	2-Way	Brushed Chrome
CLTOG1PC	1G	2-Way	Polished Chrome



Code	Size	Model	Finish
CLTOG3BC	3G	2-Way	Brushed Chrome
CLTOG3PC	3G	2-Way	Polished Chrome



Code	Size	Model	Finish
CLTOG2BC	2G	2-Way	Brushed Chrome
CLTOG2PC	2G	2-Way	Polished Chrome



Code	Size	Model	Finish
CLTOG4BC	4G	2-Way	Brushed Chrome
CLTOG4PC	4G	2-Way	Polished Chrome

TRAILING EDGE DIMMERS

- 10-200W incandescent | 5-150W LED
- Minimum mounting box depth: 25mm



Code	Size	Model	Finish
CL2181BC	1G	2-Way	Brushed Chrome
CL2181PC	1G	2-Way	Polished Chrome



Code	Size	Model	Finish
CL2183BC	3G	2-Way	Brushed Chrome
CL2183PC	3G	2-Way	Polished Chrome



Code	Size	Model	Finish
CL2182BC	2G	2-Way	Brushed Chrome
CL2182PC	2G	2-Way	Polished Chrome



Code	Size	Model	Finish
CL2184BC	4G	2-Way	Brushed Chrome
CL2184PC	4G	2-Way	Polished Chrome

FUSED SPUR UNITS

- 13A rated
- Double pole switches where applicable
- Minimum mounting box depth: 25mm



Code	Model	Finish
CL6BC	Unswitched	Brushed Chrome
CL6PC	Unswitched	Polished Chrome

20A SWITCHES

- Double pole switches
- Minimum mounting box depth: 25mm



Code	Model	Finish
CL834BC	Switched	Brushed Chrome
CL834PC	Switched	Polished Chrome



Code	Model	Finish
CL63BC	Switched	Brushed Chrome
CL63PC	Switched	Polished Chrome



Code	Model	Finish
CL834NBC	Switched + Neon	Brushed Chrome
CL834NPC	Switched + Neon	Polished Chrome



Code	Model	Finish
CL63NBC	Switched + Neon	Brushed Chrome
CL63NPC	Switched + Neon	Polished Chrome



Code	Model	Finish
CL834FBC	Switched + Neon + Flex Outlet (front)	Brushed Chrome
CL834FPC	Switched + Neon + Flex Outlet (front)	Polished Chrome



Code	Model	Finish
CL63FBC	Switched + Neon + Flex Outlet (front)	Brushed Chrome
CL63FPC	Switched + Neon + Flex Outlet (front)	Polished Chrome



45A COOKER SWITCH AND SOCKET WITH NEONS

- Double pole switches
- 13A Switched socket
- Minimum mounting box depth: 47mm

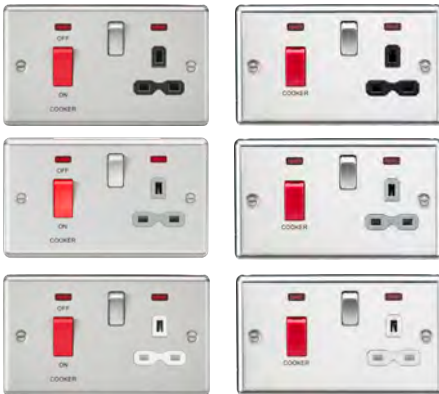

Code	Finish	Insert
CL83BC	Brushed Chrome	Black
CL83BCG	Brushed Chrome	Grey
CL83BCW	Brushed Chrome	White
CL83PC	Polished Chrome	Black
CL83PCG	Polished Chrome	Grey
CL83PCW	Polished Chrome	White

45A COOKER SWITCHES

- Double pole switches
- Neon indicator
- Minimum mounting box depth: 47mm



Code	Size	Finish
CL81NBC	Single	Brushed Chrome
CL81NPC	Single	Polished Chrome



Code	Size	Finish
CL82NBC	Double	Brushed Chrome
CL82NPC	Double	Polished Chrome

TELEPHONE SOCKETS

- Minimum mounting box depth: 25mm



Code	Model	Finish
CL73BC	Master	Brushed Chrome
CL73PC	Master	Polished Chrome
CL74BC	Extension	Brushed Chrome
CL74PC	Extension	Polished Chrome

SAT TV OUTLET

- Minimum mounting box depth: 25mm



Code	Model	Finish
CL015BC	Non-isolated	Brushed Chrome
CL015PC	Non-isolated	Polished Chrome

NETWORK OUTLETS

- Minimum mounting box depth: 25mm



Code	Model	Finish
CL45BC	RJ45	Brushed Chrome
CL45PC	RJ45	Polished Chrome

TV AND SAT TV OUTLET

- Minimum mounting box depth: 25mm



Code	Model	Finish
CL014BC	Isolated	Brushed Chrome
CL014PC	Isolated	Polished Chrome

TV OUTLET

- Minimum mounting box depth: 25mm



Code	Model	Finish
CL010BC	Non-isolated	Brushed Chrome
CL010PC	Non-isolated	Polished Chrome

DIPLEX TV & FM DAB OUTLET

- Minimum mounting box depth: 25mm



Code	Finish
CL016BC	Brushed Chrome





BLANKING PLATES



Code	Size	Finish
CL85BC	1G	Brushed Chrome
CL85PC	1G	Polished Chrome



Code	Size	Finish
CL86BC	2G	Brushed Chrome
CL86PC	2G	Polished Chrome

MODULAR FRAMES

- For use with 25mm x 50mm and/or 50mm x 50mm euro modules



Code	Model	Finish
CL1GBC	1 Module	Brushed Chrome
CL1GPC	1 Module	Polished Chrome



Code	Model	Finish
CL2GBC	1-2 Modules	Brushed Chrome
CL2GPC	1-2 Modules	Polished Chrome



Code	Model	Finish
CL4GBC	2-4 Modules	Brushed Chrome
CL4GPC	2-4 Modules	Polished Chrome



MODULAR
INSERTS
PAGES 155

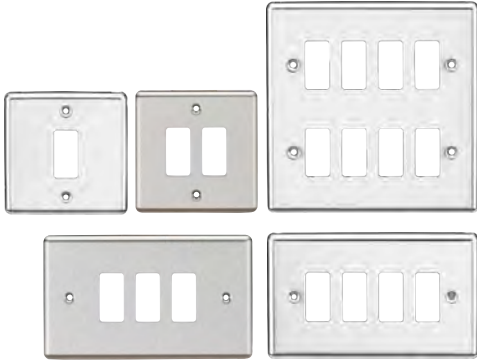

ELECTRICAL SCREWS

- M3.5 - Raised head - countersunk



Code	Screw Length	Qty
CSCREW35	35mm	100
CSCREW50	50mm	100
CSCREW75	75mm	100

GRID BACK
BOXES
PAGE 178



GRID FACEPLATES

- Requires grid mounting frame (sold separately)
- For use with Knightsbridge grid accessories only

To indicate preferred finish, replace xx on code with BC (brushed chrome) or PC (polished chrome)

Code	Size
GDCL1xx	1G
GDCL2xx	2G
GDCL3xx	3G
GDCL4xx	4G
GDCL6xx	6G
GDCL8xx	8G
GDCL9BC	9G (Brushed Chrome Only)
GDCL12BC	12G (Brushed Chrome Only)

GRID MOUNTING FRAMES

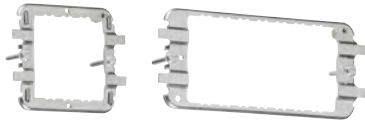

Code	Size
GDF001F	1-2G
GDF002F	3-4G



20AX GRID SWITCH MODULES

Code	Model
GDM001xx	2-Way SP
GDM002xx	DP
GDM003xx	DP + LED Indicator
GDM004xx	2-Way SP (Centre Off)
GDM005xx	Intermediate
GDM006xx	2-Way SP Retractive (Marked "PRESS")



GRID TRAILING-EDGE DIMMER MODULES

- 10-200W incandescent | 10-100W LED

Code	Model
GDM014xx	Trailing-Edge Dimmer (Press)
GDM200xx	Trailing-Edge Dimmer (Rotary)



10A GRID FAN ISOLATOR MODULES

- Triple pole
- Requires single grid position only

Code	Model
GDM020xx	Fan Isolator Switch Module
GDM021xx	Fan Isolator Key Switch Module (Supplied with Test Key)



GRID DUAL USB CHARGER MODULE

- Requires two grid positions



Code	Model
GDM016xx	Grid Dual USB Charger Module



GRID DUMMY DIMMER MODULE

- Push on/off function only
- Ideal for situations where you require one position to look like a dimmer but act like a switch

Code	Model
GDM022xx	6A 2-Way



20AX GRID KEY SWITCH MODULES

- Supplied with test key

Code	Model
GDM007xx	2-Way SP (Marked "EMG LTG TEST")
GDM008xx	DP (Marked "EMG LTG TEST")
GDM009xx	2-Way SP
GDM010xx	DP
GDKEY	Spare Key



MISCELLANEOUS GRID MODULES

Code	Model
GDM011xx	Fuse Holder (13A)
GDM012xx	Flex Outlet (Max. 10mm)
GDM013xx	Blank
GDM017	Indicator - Green
GDM018	Indicator - Red
GDM019	Indicator - Orange



GRID ROCKER COVERS

- Easy to install
- Replace an existing rocker with an engraved version indicating the appliance it refers to

Code	Model	
GDB00STxx	Fan Boost	
GDBOILxx	Boiler	
GDCOFFxx	Coffee Machine	NEW
GDCOOKxx	Cooker Hood	
GDDISHxx	Dishwasher	
GDFANxx	Fan	
GDFREEZERxx	Freezer	NEW
GDFRIDGExx	Fridge	NEW
GDFRIDxx	Fridge Freezer	
GDHOBxx	Hob	
GDMICROxx	Microwave	
GDOVENxx	Oven	
GDDRYxx	Tumble Dryer	
GDWARMxx	Warming Drawer	NEW
GDWASHxx	Washing Machine	
GDWASTExx	Waste Disposal	NEW
GDWINExx	Wine Cooler	NEW



2G
INTERMEDIATE
SWITCHES
can be made
using GDM005BC



ENGRAVED ROCKER COVERS

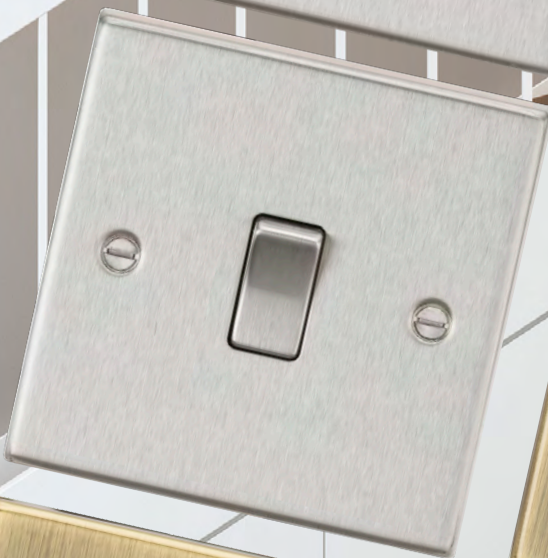

METAL DECORATIVE SWITCHES & SOCKETS

SQUARE EDGE

A comprehensive range of metal decorative switches and sockets with a square edge design

13A 2G Sockets / 13A 2G USB Sockets (inc. FASTCHARGE) / Phone Holder	48 - 49
13A 1G Sockets / 13A 1G USB Sockets / Bluetooth Speaker	50
Fan Isolator Switches / Shaver Sockets / Round Pin Sockets	51
10AX Switches	52
10AX Toggle Switches / Dimmers	53
Fused Spur Units / 20A Switches	54
45A Cooker Switches and Sockets	55
Media Outlets	56
Blanking Plates / Modular Frames	57
Grid Wiring Accessories	58 - 60

COLOUR MATCHING

Matching metal rockers with no surround

DOUBLE POLE SWITCHES

On selected products for additional safety

LONG LASTING

Robust full metal housing

SQUARE EDGE DESIGN

Projection of 10.5mm (including gasket)

UNIQUE SOCKET DESIGN

Socket completely concealed by plug once inserted

CAPTIVE TERMINALS

Appropriate terminal capacities and captive terminals to prevent screws falling out

INTEGRATED MOISTURE GASKET

Prevents any moisture transfer to decorative front plate

HIGH INTEGRITY EARTHING

Twin earth terminals where appropriate

15 YEAR WARRANTY*

*2 years on electronic products

DIMENSIONS*

Single plate: 89mm x 89mm
Double plate: 89mm x 149mm
Projection: 10.5mm

*Unless otherwise stated



Only high-quality imported US ICs and USB Controllers are used in this range, ensuring trouble-free charging and longevity for hospitality areas



Brushed Chrome | Metal style

INSERT OPTIONS



Antique Brass | Metal style

FINISH OPTIONS



13A 2G DP SWITCHED SOCKETS

- Minimum mounting box depth: 25mm



Code	Finish	Insert
CS9BC	Brushed Chrome	Black
CS9BCG	Brushed Chrome	Grey
CS9BCW	Brushed Chrome	White
CS9AB	Antique Brass	Black

13A 2G SWITCHED SOCKETS WITH USB

- Minimum mounting box depth: 25mm-35mm (dependent on wiring conditions)



Code	Finish	Insert
CS9224BC	Brushed Chrome	Black
CS9224BCG	Brushed Chrome	Grey
CS9224BCW	Brushed Chrome	White
CS9224AB	Antique Brass	Black

FLIP-DOWN PHONE HOLDER

- Handy flip-down phone holder for use with double switched sockets with USB charging facility
- Two-piece install - no need to remove socket from wall
- Sits behind the existing double switched socket
- Fold down shelf for supporting your device whilst charging - folds up when not in use

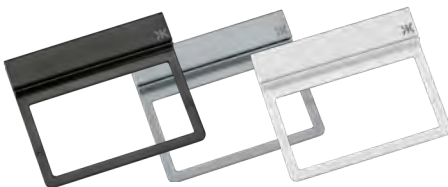

Code	Finish
2GPHBK	Black
2GPHGY	Grey
2GPHW	White

13A 2G DP SWITCHED SOCKETS WITH FASTCHARGE USB

- FASTCHARGE USB-C port compatible with QC2.0/QC3.0 and USB-PD
- FASTCHARGE USB-A port compatible with QC2.0/QC3.0
- Capable of delivering 0-50% charge in under 30 mins with compatible phones
- 80% faster than a standard 5V DC 2A charger
- Compatible with Android based devices supporting QC2.0/QC3.0 and USB-PD (via USB-C port only)
- Compatible with Apple devices supporting USB-PD (iPhone 8 and above, require certified Lightning to USB-C charge/sync cable)



FASTCHARGE



Code	Finish	Insert
CS9909BC	Brushed Chrome	Black
CS9909BCG	Brushed Chrome	Grey
CS9909BCW	Brushed Chrome	White

13A SWITCHED SOCKET WITH QUAD USB CHARGER

- USB charging rate: 5V DC 5.1A (shared)
- 3 ports share 3A
- 1 port dedicated 2.1A
- Minimum mounting box depth: 25mm-35mm (dependent on wiring conditions)



Code	Finish	Insert
CS7USB4BC	Brushed Chrome	Black
CS7USB4BCG	Brushed Chrome	Grey
CS7USB4BCW	Brushed Chrome	White

45A SWITCH AND SOCKET WITH DUAL USB CHARGER

- Double pole switches
- 13A switched socket
- Minimum mounting box depth: 47mm



Code	Model	Insert
CS8333UBC	Switched + Dual USB	Black
CS8333UBCG	Switched + Dual USB	Grey
CS8333UBCW	Switched + Dual USB	White

13A SWITCHED SOCKET WITH DUAL USB CHARGER AND BLUETOOTH SPEAKER

- 3W RMS bluetooth speaker
- Minimum mounting box depth: 25-35mm (dependent on wiring conditions)



Code	Finish	Insert
CS9905BC	Brushed Chrome	Black
CS9905BCG	Brushed Chrome	Grey
CS9905BCW	Brushed Chrome	White



13A 1G DP SWITCHED SOCKETS



Code	Finish	Insert
CS7BC	Brushed Chrome	Black
CS7BCG	Brushed Chrome	Grey
CS7BCW	Brushed Chrome	White
CS7AB	Antique Brass	Black

13A 1G SWITCHED SOCKETS WITH USB



Code	Finish	Insert
CS9124BC	Brushed Chrome	Black NEW
CS9124BCG	Brushed Chrome	Grey NEW
CS9124BCW	Brushed Chrome	White NEW
CS9124AB	Antique Brass	Black NEW

QUAD USB CHARGER OUTLET

- 3 ports share 3A
- 1 port dedicated 2.1A
- Minimum mounting box depth: 25mm-35mm (dependent on wiring conditions)



Code	Finish	Insert
CSQUADBC	Brushed Chrome	Black
CSQUADBCG	Brushed Chrome	Grey
CSQUADBCW	Brushed Chrome	White

FLUSH MOUNT BLUETOOTH SPEAKER

- 3W RMS bluetooth speaker
- Minimum mounting box depth: 25mm-35mm (dependent on wiring conditions)



Code	Finish
CSBLUEBC	Brushed Chrome

DUAL VOLTAGE SHAVER SOCKETS

- IP41 rated
- 115/230V 20VA rated
- Minimum mounting box depth: 47mm



Code	Finish	Insert
CS89BC	Brushed Chrome	Black
CS89BCG	Brushed Chrome	Grey
CS89BCW	Brushed Chrome	White
CS89AB	Antique Brass	Black

ROUND PIN SOCKETS

- 5A rated
- Minimum mounting box depth: 25mm



Code	Finish	Insert
CS5ABC	Brushed Chrome	Black
CS5ABCG	Brushed Chrome	Grey
CS5ABCW	Brushed Chrome	White
CS5AAB	Antique Brass	Black

10AX FAN ISOLATOR SWITCH

- Minimum mounting box depth: 16mm
- Triple pole



Code	Finish
CS11BC	Brushed Chrome
CS11AB	Antique Brass



GRID FAN
ISOLATOR
MODULES
PAGE 59



10AX SWITCHES

- Minimum mounting box depth: 16mm



Code	Size	Model	Finish
CS12BC	1G	Intermediate	Brushed Chrome
CS12AB	1G	Intermediate	Antique Brass

Code	Size	Model	Finish
CS2BC	1G	2-Way	Brushed Chrome
CS2AB	1G	2-Way	Antique Brass



Code	Size	Model	Finish
CS3BC	2G	2-Way	Brushed Chrome
CS3AB	2G	2-Way	Antique Brass



Code	Size	Model	Finish
CS41BC	4G	2-Way	Brushed Chrome
CS41AB	4G	2-Way	Antique Brass



Code	Size	Model	Finish
CS4BC	3G	2-Way	Brushed Chrome
CS4AB	3G	2-Way	Antique Brass



Code	Size	Model	Finish
CS42BC	6G	2-Way	Brushed Chrome
CS42AB	6G	2-Way	Antique Brass

10AX TOGGLE SWITCHES

- Minimum mounting box depth: 16mm



Code	Size	Model	Finish
CSTOG12BC	1G	Intermediate	Brushed Chrome
CSTOG12AB	1G	Intermediate	Antique Brass
CSTOG1BC	1G	2-Way	Brushed Chrome
CSTOG1AB	1G	2-Way	Antique Brass



Code	Size	Model	Finish
CSTOG2BC	2G	2-Way	Brushed Chrome
CSTOG2AB	2G	2-Way	Antique Brass



Code	Size	Model	Finish
CSTOG3BC	3G	2-Way	Brushed Chrome
CSTOG3AB	3G	2-Way	Antique Brass



Code	Size	Model	Finish
CSTOG4BC	4G	2-Way	Brushed Chrome
CSTOG4AB	4G	2-Way	Antique Brass

TRAILING-EDGE DIMMERS

- 10-200W incandescent | 5-150W LED
- Minimum mounting box depth: 25mm

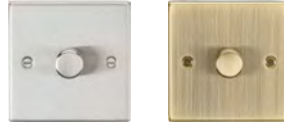

Code	Size	Model	Finish
CS2181BC	1G	2-Way	Brushed Chrome
CS2181AB	1G	2-Way	Antique Brass



Code	Size	Model	Finish
CS2182BC	2G	2-Way	Brushed Chrome
CS2182AB	2G	2-Way	Antique Brass



Code	Size	Model	Finish
CS2183BC	3G	2-Way	Brushed Chrome
CS2183AB	3G	2-Way	Antique Brass



Code	Size	Model	Finish
CS2184BC	4G	2-Way	Brushed Chrome
CS2184AB	4G	2-Way	Antique Brass





FUSED SPUR UNITS

- 13A rated
- Double pole switches where applicable
- Minimum mounting box depth: 25mm



Code	Model	Finish
CS6BC	Unswitched	Brushed Chrome
CS6AB	Unswitched	Antique Brass
CS6NAB	Unswitched + Neon	Antique Brass

20A SWITCHES

- Double pole switches
- Minimum mounting box depth: 25mm



Code	Model	Finish
CS834BC	Switched	Brushed Chrome
CS834AB	Switched	Antique Brass



Code	Model	Finish
CS63BC	Switched	Brushed Chrome
CS63AB	Switched	Antique Brass



Code	Model	Finish
CS834NBC	Switched + Neon	Brushed Chrome
CS834NAB	Switched + Neon	Antique Brass



Code	Model	Finish
CS63NBC	Switched + Neon	Brushed Chrome
CS63NAB	Switched + Neon	Antique Brass



Code	Model	Finish
CS834FBC	Switched + Neon + Flex Outlet (front)	Brushed Chrome
CS834FAB	Switched + Neon + Flex Outlet (front)	Antique Brass



Code	Model	Finish
CS63FBC	Switched + Neon + Flex Outlet (front)	Brushed Chrome
CS63FAB	Switched + Neon + Flex Outlet (front)	Antique Brass



45A COOKER SWITCHES WITH NEONS

- Double pole switches
- Minimum mounting box depth: 47mm



Code	Size	Finish
CS81NBC	Single	Brushed Chrome
CS81NAB	Single	Antique Brass

45A COOKER SWITCHES WITH NEONS

- Double pole switches
- Minimum mounting box depth: 47mm



Code	Size	Finish
CS82NBC	Double	Brushed Chrome
CS82NAB	Double	Antique Brass

45A COOKER SWITCH AND SOCKET WITH NEONS

- Double pole switches
- 13A switched socket
- Minimum mounting box depth: 47mm



Code	Finish	Insert
CS83BC	Brushed Chrome	Black
CS83BCG	Brushed Chrome	Grey
CS83BCW	Brushed Chrome	White
CS83AB	Antique Brass	Black



USB MODELS
SEE PAGE 49



TELEPHONE SOCKETS

- Minimum mounting box depth: 25mm



Code	Model	Finish
CS73BC	Master	Brushed Chrome
CS73AB	Master	Antique Brass
CS74BC	Extension	Brushed Chrome
CS74AB	Extension	Antique Brass

SAT TV OUTLET

- Minimum mounting box depth: 25mm



Code	Model	Finish
CS015BC	Non-isolated	Brushed Chrome
CS015AB	Non-isolated	Antique Brass

NETWORK OUTLETS

- Minimum mounting box depth: 25mm



Code	Model	Finish
CS45BC	RJ45	Brushed Chrome
CS45AB	RJ45	Antique Brass

TV AND SAT TV OUTLET

- Minimum mounting box depth: 25mm



Code	Model	Finish
CS014BC	Isolated	Brushed Chrome
CS014AB	Isolated	Antique Brass

TV OUTLET

- Minimum mounting box depth: 25mm



Code	Model	Finish
CS010BC	Non-isolated	Brushed Chrome
CS010AB	Non-isolated	Antique Brass



BLANKING PLATES



Code	Size	Finish
CS85BC	1G	Brushed Chrome
CS85AB	1G	Antique Brass



Code	Size	Finish
CS86BC	2G	Brushed Chrome
CS86AB	2G	Antique Brass

MODULAR FRAMES

- For use with 25mm x 50mm and/or 50mm x 50mm euro modules



Code	Model	Finish
CS1GBC	1 Module	Brushed Chrome
CS1GAB	1 Module	Antique Brass



Code	Model	Finish
CS2GBC	1-2 Modules	Brushed Chrome
CS2GAB	1-2 Modules	Antique Brass



Code	Model	Finish
CS4GBC	2-4 Modules	Brushed Chrome
CS4GAB	2-4 Modules	Antique Brass



MODULAR
INSERTS
AVAILABLE
PAGE 155



GRID FACEPLATES

- Requires grid mounting frame (sold separately)
- For use with Knightsbridge Grid accessories only

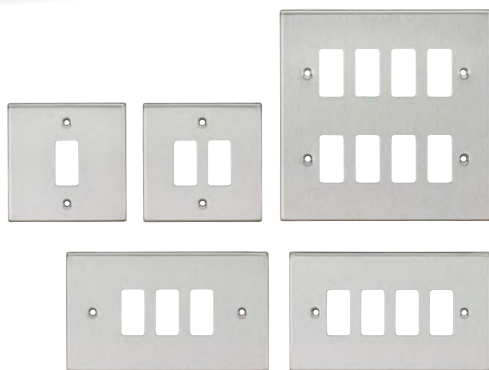

Code	Size
GDCS1BC	1G
GDCS2BC	2G
GDCS3BC	3G
GDCS4BC	4G
GDCS6BC	6G
GDCS8BC	8G
GDCS9BC	9G
GDCS12BC	12G

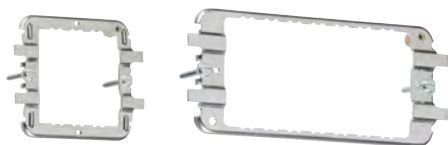

GRID MOUNTING FRAMES

Code	Size
GDF001F	1-2G
GDF002F	3-4G

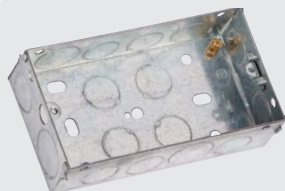

GRID
BACK BOXES
PAGE
178



20AX GRID SWITCH MODULES

Code	Model
GDM001BC	2-Way SP
GDM002BC	DP
GDM003BC	DP + LED Indicator
GDM004BC	2-Way SP (centre-off)
GDM005BC	Intermediate
GDM006BC	2-Way SP Retractive (marked "PRESS")



10A GRID FAN ISOLATOR MODULES

- Triple pole
- Requires single grid position only

Code	Model
GDM020BC	Fan Isolator Switch Module
GDM021BC	Fan Isolator Key Switch Module (supplied with test key)



20AX GRID KEY SWITCH MODULES

- Supplied with test key

Code	Model
GDM007BC	2-Way SP (marked "EMG LTG TEST")
GDM008BC	DP (marked "EMG LTG TEST")
GDM009BC	2-Way SP
GDM010BC	DP
GDKEY	Spare Key



GRID TRAILING-EDGE DIMMER MODULES

- 10-200W incandescent | 10-100W LED

Code	Model
GDM014BC	Trailing-Edge Dimmer (Press)
GDM200BC	Trailing-Edge Dimmer (Rotary)

2G
INTERMEDIATE
SWITCHES
can be made
using
GDM005BC





GRID DUMMY DIMMER MODULE

- Push on/off function only
- Ideal for situations where you require one position to look like a dimmer but act like a switch

Code	Model
GDM022BC	6A 2-Way



GRID DUAL USB CHARGER MODULE

- Requires two grid positions



Code	Model
GDM016BC	Dual USB Charger Module



MISCELLANEOUS GRID MODULES

Code	Model
GDM011BC	Fuse Holder (13A)
GDM012BC	Flex Outlet (max. 10mm)
GDM013BC	Blank
GDM017	Indicator - Green
GDM018	Indicator - Red
GDM019	Indicator - Orange



GRID ROCKER COVERS

- Easy to install
- Replace an existing rocker with an engraved version indicating the appliance it refers to

Code	Model
GDBOILBC	Boiler
GDCOFFBC	Coffee Machine NEW
GDHOODBC	Cooker Hood
GDDISHBC	Dishwasher
GDFANBC	Fan
GDBOOSTBC	Fan Boost NEW
GDFREEZERBC	Freezer NEW
GDFRIDGEBC	Fridge NEW
GDFRIDBC	Fridge Freezer
GDHOBBC	Hob
GDMICROBC	Microwave

Code	Model
GDOVENBC	Oven
GDDRYBC	Tumble Dryer
GDWARMBC	Warming Drawer NEW
GDWASHBC	Washine Machine
GDWASTEBC	Waste Disposal NEW
GDWINEBC	Wine Cooler NEW



ENGRAVED ROCKER COVERS

SINGLE GRID POSITION FAN ISOLATOR SWITCH

Exclusive to **Knightsbridge**

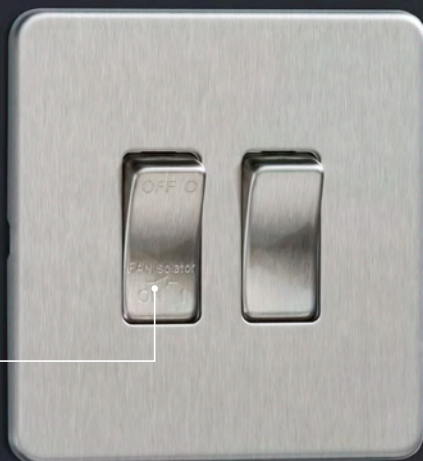

CONTROL EXTRACTOR FANS THROUGH A SINGLE WALL SWITCH



TRIPLE POLE



HUGE TIME SAVINGS
Eliminates the need for over-door fan isolator switches



OPTIONS FIT FOR DOMESTIC OR COMMERCIAL USE
Switch and key switch modules available in a variety of finishes



TECHNICAL DETAILS

- Product code:
GDM020XX (switch)
GDM021XX (key switch)
- 10A rated
- Triple pole
- Engraved text
- Quick install: easy clip-in system
- For fans requiring a fuse, use a GDM011XX fuse holder alongside the fan isolator switch options
- Uses just a single grid position





METAL DECORATIVE SWITCHES & SOCKETS

FLAT PLATE

Metal decorative switches and sockets featuring an ultra slim profile design

13A 2G Sockets	66
13A 2G USB Sockets / Phone Holder	67 - 69
13A 1G Sockets / 13A 1G USB Sockets / Floor Sockets	70 - 71
Shaver Sockets	72
Round Pin Sockets / Fan Isolator Switches	73
10AX Switches	74 - 75
10AX Toggle Switches	76
Dimmers	77
Fused Spur Units	78 - 79
20A Switches	80
45A Cooker Switches and Sockets	81
Media Outlets / Blanking Plates	82 - 83
Modular Frames	84
Grid Wiring Accessories	85 - 87

COLOUR MATCHING

Matching metal rockers with no surround

DOUBLE POLE SWITCHES

On selected products for additional safety

LONG LASTING

Robust full metal housing

UNIQUE SOCKET DESIGN

Socket completely concealed by plug once inserted

ULTRA-SLIM DESIGN

Projection of just 2.5mm (including gasket)



CAPTIVE TERMINALS

Appropriate terminal capacities and captive terminals to prevent screws falling out

HIGH INTEGRITY EARTHING

Twin earth terminals where appropriate

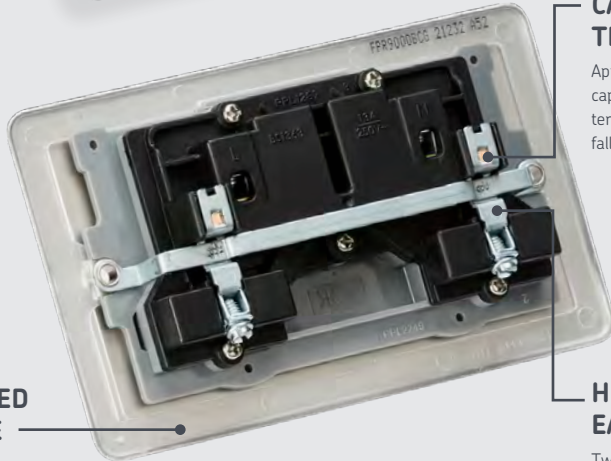

INTEGRATED MOISTURE GASKET

Prevents any moisture transfer to decorative front plate

15 YEAR WARRANTY*

*2 years on electronic products

DIMENSIONS*

Single plate: 87.5mm x 87.5mm
Double plate: 87.5mm x 147.5mm
Projection: 2.5mm

*Unless otherwise stated



Only high-quality imported US ICs and USB Controllers are used in this range, ensuring trouble-free charging and longevity for hospitality areas

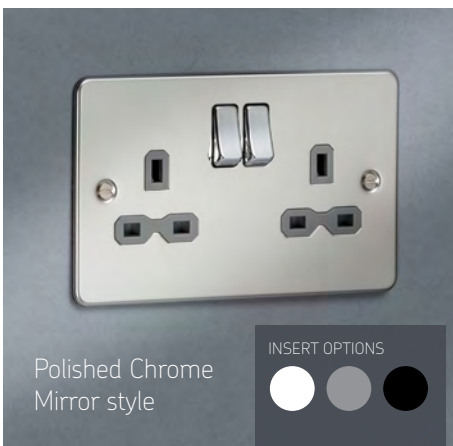
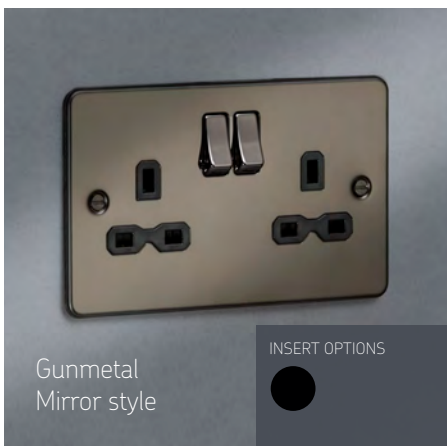
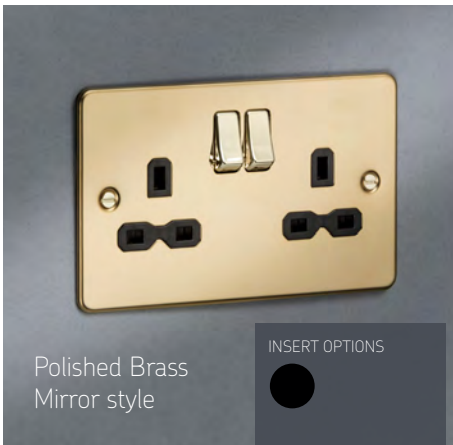
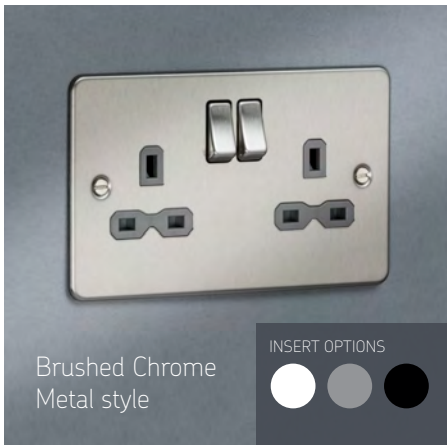
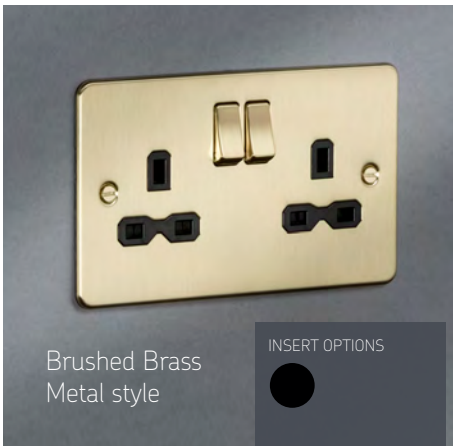

FINISH OPTIONS



FPR9000BN

13A 2G DP SWITCHED SOCKETS

- Twin earth
- Minimum mounting box depth: 25mm



Code	Finish	Insert
FPR9000BC	Brushed Chrome	Black
FPR9000BCG	Brushed Chrome	Grey
FPR9000BCW	Brushed Chrome	White
FPR9000GM	Gunmetal	Black
FPR9000PB	Polished Brass	Black

Code	Finish	Insert
FPR9000PLW	Pearl	White
FPR9000BB	Brushed Brass	Black
FPR9000PC	Polished Chrome	Black
FPR9000PCG	Polished Chrome	Grey
FPR9000PCW	Polished Chrome	White



FPR9000PB

13A 2G SWITCHED SOCKETS WITH USB

- Twin earth
- Minimum mounting box depth: 25mm-35mm (dependent on wiring conditions)



Code	Finish	Insert
FPR9224BC	Brushed Chrome	Black
FPR9224BCG	Brushed Chrome	Grey
FPR9224BCW	Brushed Chrome	White
FPR9224GM	Gunmetal	Black
FPR9224PB	Polished Brass	Black

Code	Finish	Insert
FPR9224PLW	Pearl	White
FPR9224BB	Brushed Brass	Black
FPR9224PC	Polished Chrome	Black
FPR9224PCG	Polished Chrome	Grey
FPR9224PCW	Polished Chrome	White



2G FLIP-DOWN PHONE HOLDER

- Handy flip-down phone holder for use with double switched sockets with USB charging facility
- Two-piece install - no need to remove socket from wall
- Sits behind the existing double switched socket
- Fold down shelf for supporting your device whilst charging - folds up when not in use

Code	Finish
2GPHBK	Black
2GPHGY	Grey
2GPHW	White



13A 2G SWITCHED SOCKET WITH DUAL USB CHARGER AND CHARGING INDICATORS

- Twin earth • LED charging indicators
- Minimum mounting box depth: 25mm-35mm (dependent on wiring conditions)



Code	Finish	Insert
FPR9904NBC	Brushed Chrome	Black
FPR9904NBCG	Brushed Chrome	Grey
FPR9904NBCW	Brushed Chrome	White



13A SWITCHED SOCKET WITH QUAD USB CHARGER

- 3 ports share 3A
- 1 port dedicated 2.1A
- Minimum mounting box depth: 25mm-35mm (dependent on wiring conditions)



Code	Finish	Insert
FPR7USB4BC	Brushed Chrome	Black
FPR7USB4BCG	Brushed Chrome	Grey
FPR7USB4BCW	Brushed Chrome	White
FPR7USB4GM	Gunmetal	Black
FPR7USB4PB	Polished Brass	Black
FPR7USB4PLW	Pearl	White
FPR7USB4BB	Brushed Brass	Black
FPR7USB4PC	Polished Chrome	Black
FPR7USB4PCG	Polished Chrome	Grey
FPR7USB4PCW	Polished Chrome	White

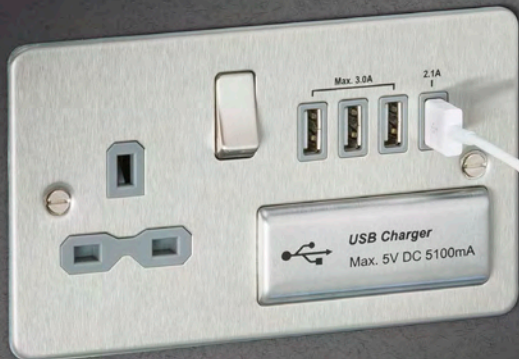

13A SWITCHED SOCKET WITH DUAL USB CHARGER AND BLUETOOTH SPEAKER

- 3W RMS bluetooth speaker
- Minimum mounting box depth: 25mm-35mm (dependent on wiring conditions)



Code	Finish	Insert
FPR9905BC	Brushed Chrome	Black
FPR9905BCG	Brushed Chrome	Grey
FPR9905BCW	Brushed Chrome	White





13A 1G SWITCHED SOCKETS

- Twin earth • Double pole switches
- Minimum mounting box depth: 25mm



Code	Finish	Insert
FPR7000BC	Brushed Chrome	Black
FPR7000BCG	Brushed Chrome	Grey
FPR7000BCW	Brushed Chrome	White
FPR7000GM	Gunmetal	Black
FPR7000PB	Polished Brass	Black

Code	Finish	Insert
FPR7000PLW	Pearl	White
FPR7000BB	Brushed Brass	Black
FPR7000PC	Polished Chrome	Black
FPR7000PCG	Polished Chrome	Grey
FPR7000PCW	Polished Chrome	White

13A 1G SWITCHED SOCKETS WITH USB

- Minimum mounting box depth: 25mm-35mm (dependent on wiring conditions)



Code	Finish	Insert	
FPR9124BC	Brushed Chrome	Black	NEW
FPR9124BCG	Brushed Chrome	Grey	NEW
FPR9124BCW	Brushed Chrome	White	NEW
FPR9124GM	Gunmetal	Black	NEW
FPR9124PB	Polished Brass	Black	NEW

Code	Finish	Insert	
FPR9124PLW	Pearl	White	NEW
FPR9124BB	Brushed Brass	Black	NEW
FPR9124PC	Polished Chrome	Black	NEW
FPR9124PCG	Polished Chrome	Grey	NEW
FPR9124PCW	Polished Chrome	White	NEW

FLOOR SOCKETS

- 13A rated • Unswitched • Spring-loaded cover • Minimum recessed depth: 35mm
- 1G: 94.5mm x 86mm 2G: 94.5mm x 144mm



Code	Finish	Insert
FPR7UPBW	Polished Brass	White
FPR7UPCW	Polished Chrome	White
FPR7UBBW	Brushed Brass	White
FPR7UBCW	Brushed Chrome	White

Code	Finish	Insert
FPR9UPBW	Polished Brass	White
FPR9UPCW	Polished Chrome	White
FPR9UBBW	Brushed Brass	White
FPR9UBCW	Brushed Chrome	White

QUAD USB CHARGER OUTLET

- 3 ports share 3A
- 1 port dedicated 2.1A
- Minimum mounting box depth: 25mm-35mm (dependent on wiring conditions)



Code	Finish	Insert
FPQUADBC	Brushed Chrome	Black
FPQUADBCG	Brushed Chrome	Grey
FPQUADBCW	Brushed Chrome	White
FPQUADGM	Gunmetal	Black
FPQUADPB	Polished Brass	Black

Code	Finish	Insert
FPQUADPLW	Pearl	White
FPQUADBB	Brushed Brass	Black
FPQUADPC	Polished Chrome	Black
FPQUADPCG	Polished Chrome	Grey
FPQUADPCW	Polished Chrome	White



DUAL VOLTAGE SHAVER SOCKETS

- Minimum mounting box depth: 47mm
- 115/230V 20VA rated
- IP41 rated



Code	Finish	Insert
FP8900BC	Brushed Chrome	Black
FP8900BCG	Brushed Chrome	Grey
FP8900BCW	Brushed Chrome	White
FP8900GM	Gunmetal	Black
FP8900PB	Polished Brass	Black

Code	Finish	Insert
FP8900PLW	Pearl	White
FP8900BB	Brushed Brass	Black
FP8900PC	Polished Chrome	Black
FP8900PCG	Polished Chrome	Grey
FP8900PCW	Polished Chrome	White



ROUND PIN SOCKETS

- 5A rated
- Minimum mounting box depth: 25mm • Unswitched



Code	Finish	Insert
FP5ABC	Brushed Chrome	Black
FP5ABCG	Brushed Chrome	Grey
FP5ABCW	Brushed Chrome	White
FP5AGM	Gunmetal	Black
FP5APB	Polished Brass	Black

Code	Finish	Insert
FP5APLW	Pearl	White
FP5ABB	Brushed Brass	Black
FP5APC	Polished Chrome	Black
FP5APCG	Polished Chrome	Grey
FP5APCW	Polished Chrome	White

10AX FAN ISOLATOR SWITCHES

- Triple pole
- Minimum mounting box depth: 16mm



Code	Finish
FP1100BC	Brushed Chrome
FP1100GM	Gunmetal
FP1100PB	Polished Brass

Code	Finish
FP1100PL	Pearl
FP1100BB	Brushed Brass
FP1100PC	Polished Chrome



**GRID FAN ISOLATOR
MODULES PAGE 87**



FP2000BN

10AX SWITCHES

- Minimum mounting box depth: 16mm



Code	Size	Model	Finish
FP1200BC	1G	Intermediate	Brushed Chrome
FP1200GM	1G	Intermediate	Gunmetal
FP1200PB	1G	Intermediate	Polished Brass
FP1200PL	1G	Intermediate	Pearl
FP1200BB	1G	Intermediate	Brushed Brass
FP1200PC	1G	Intermediate	Polished Chrome

Code	Size	Model	Finish
FP2000BC	1G	2-Way	Brushed Chrome
FP2000GM	1G	2-Way	Gunmetal
FP2000PB	1G	2-Way	Polished Brass
FP2000PL	1G	2-Way	Pearl
FP2000BB	1G	2-Way	Brushed Brass
FP2000PC	1G	2-Way	Polished Chrome

10AX SWITCHES

- Minimum mounting box depth: 16mm

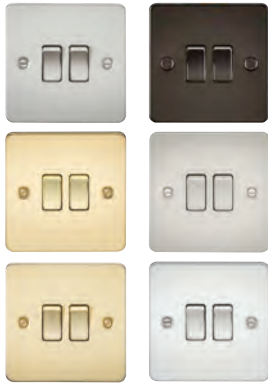

Code	Size	Model	Finish
FP3000BC	2G	2-Way	Brushed Chrome
FP3000GM	2G	2-Way	Gunmetal
FP3000PB	2G	2-Way	Polished Brass
FP3000PL	2G	2-Way	Pearl
FP3000BB	2G	2-Way	Brushed Brass
FP3000PC	2G	2-Way	Polished Chrome

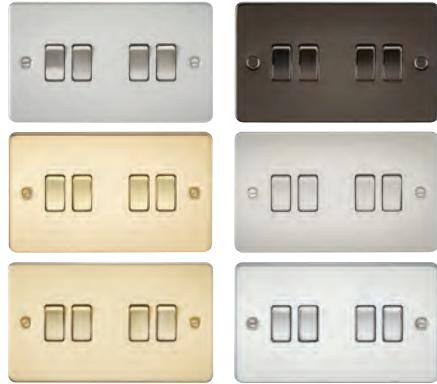

Code	Size	Model	Finish
FP4100BC	4G	2-Way	Brushed Chrome
FP4100GM	4G	2-Way	Gunmetal
FP4100PB	4G	2-Way	Polished Brass
FP4100PL	4G	2-Way	Pearl
FP4100BB	4G	2-Way	Brushed Brass
FP4100PC	4G	2-Way	Polished Chrome



Code	Size	Model	Finish
FP4000BC	3G	2-Way	Brushed Chrome
FP4000GM	3G	2-Way	Gunmetal
FP4000PB	3G	2-Way	Polished Brass
FP4000PL	3G	2-Way	Pearl
FP4000BB	3G	2-Way	Brushed Brass
FP4000PC	3G	2-Way	Polished Chrome

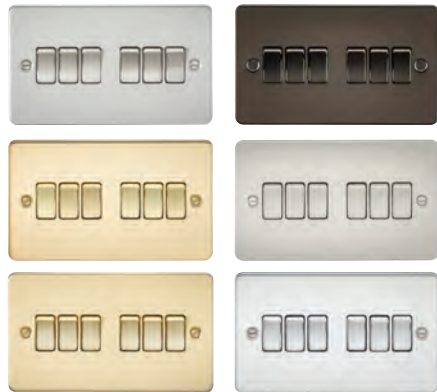

Code	Size	Model	Finish
FP4200BC	6G	2-Way	Brushed Chrome
FP4200GM	6G	2-Way	Gunmetal
FP4200PB	6G	2-Way	Polished Brass
FP4200PL	6G	2-Way	Pearl
FP4200BB	6G	2-Way	Brushed Brass
FP4200PC	6G	2-Way	Polished Chrome



10AX TOGGLE SWITCHES

- Minimum mounting box depth: 16mm



Code	Size	Model	Finish
FP12TOGBC	1G	Intermediate	Brushed Chrome
FP12TOGGM	1G	Intermediate	Gunmetal
FP12TOGPB	1G	Intermediate	Polished Brass
FP12TOGPL	1G	Intermediate	Pearl
FP12TOGBB	1G	Intermediate	Brushed Brass
FP12TOGPC	1G	Intermediate	Polished Chrome

Code	Size	Model	Finish
FP1TOGBC	1G	2-Way	Brushed Chrome
FP1TOGGM	1G	2-Way	Gunmetal
FP1TOGPB	1G	2-Way	Polished Brass
FP1TOGPL	1G	2-Way	Pearl
FP1TOGBB	1G	2-Way	Brushed Brass
FP1TOGPC	1G	2-Way	Polished Chrome



Code	Size	Model	Finish
FP2TOGBC	2G	2-Way	Brushed Chrome
FP2TOGGM	2G	2-Way	Gunmetal
FP2TOGPB	2G	2-Way	Polished Brass

Code	Size	Model	Finish
FP2TOGPL	2G	2-Way	Pearl
FP2TOGBB	2G	2-Way	Brushed Brass
FP2TOGPC	2G	2-Way	Polished Chrome

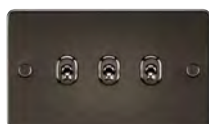

Code	Size	Model	Finish
FP3TOGBC	3G	2-Way	Brushed Chrome
FP3TOGGM	3G	2-Way	Gunmetal
FP3TOGPB	3G	2-Way	Polished Brass
FP3TOGPL	3G	2-Way	Pearl
FP3TOGBB	3G	2-Way	Brushed Brass
FP3TOGPC	3G	2-Way	Polished Chrome

Code	Size	Model	Finish
FP4TOGBC	4G	2-Way	Brushed Chrome
FP4TOGGM	4G	2-Way	Gunmetal
FP4TOGPB	4G	2-Way	Polished Brass
FP4TOGPL	4G	2-Way	Pearl
FP4TOGBB	4G	2-Way	Brushed Brass
FP4TOGPC	4G	2-Way	Polished Chrome

TRAILING-EDGE DIMMERS

- 10-200W incandescent | 5-150W LED
- Minimum mounting box depth: 25mm



Code	Size	Model	Finish
FP2181BC	1G	2-Way	Brushed Chrome
FP2181GM	1G	2-Way	Gunmetal
FP2181PB	1G	2-Way	Polished Brass
FP2181PL	1G	2-Way	Pearl
FP2181BB	1G	2-Way	Brushed Brass
FP2181PC	1G	2-Way	Polished Chrome



Code	Size	Model	Finish
FP2183BC	3G	2-Way	Brushed Chrome
FP2183GM	3G	2-Way	Gunmetal
FP2183PB	3G	2-Way	Polished Brass
FP2183PL	3G	2-Way	Pearl
FP2183BB	3G	2-Way	Brushed Brass
FP2183PC	3G	2-Way	Polished Chrome



Code	Size	Model	Finish
FP2182BC	2G	2-Way	Brushed Chrome
FP2182GM	2G	2-Way	Gunmetal
FP2182PB	2G	2-Way	Polished Brass
FP2182PL	2G	2-Way	Pearl
FP2182BB	2G	2-Way	Brushed Brass
FP2182PC	2G	2-Way	Polished Chrome



Code	Size	Model	Finish
FP2184BC	4G	2-Way	Brushed Chrome
FP2184GM	4G	2-Way	Gunmetal
FP2184PB	4G	2-Way	Polished Brass
FP2184PL	4G	2-Way	Pearl
FP2184BB	4G	2-Way	Brushed Brass
FP2184PC	4G	2-Way	Polished Chrome



FUSED SPUR UNITS

• 13A rated • Double pole switches where applicable • Minimum mounting box depth: 25mm



Code	Model	Finish
FP6000BC	Unswitched	Brushed Chrome
FP6000GM	Unswitched	Gunmetal
FP6000PB	Unswitched	Polished Brass
FP6000PL	Unswitched	Pearl
FP6000BB	Unswitched	Brushed Brass
FP6000PC	Unswitched	Polished Chrome

Code	Model	Finish
FP6300NBC	Switched + Neon	Brushed Chrome
FP6300NGM	Switched + Neon	Gunmetal
FP6300NPB	Switched + Neon	Polished Brass
FP6300NPL	Switched + Neon	Pearl
FP6300NBB	Switched + Neon	Brushed Brass
FP6300NPC	Switched + Neon	Polished Chrome





Code	Model	Finish
FP6300BC	Switched	Brushed Chrome
FP6300GM	Switched	Gunmetal
FP6300PB	Switched	Polished Brass
FP6300PL	Switched	Pearl
FP6300BB	Switched	Brushed Brass
FP6300PC	Switched	Polished Chrome

Code	Model	Finish
FP6300FBC	Switched + Neon + Flex Outlet (Front)	Brushed Chrome
FP6300FGM	Switched + Neon + Flex Outlet (Front)	Gunmetal
FP6300FPB	Switched + Neon + Flex Outlet (Front)	Polished Brass
FP6300FPL	Switched + Neon + Flex Outlet (Front)	Pearl
FP6300FBB	Switched + Neon + Flex Outlet (Front)	Brushed Brass
FP6300FPC	Switched + Neon + Flex Outlet (Front)	Polished Chrome



Code	Model	Finish
FP6000NPC	Unswitched + Neon	Polished Chrome
FP6000NGM	Unswitched + Neon	Gunmetal
FP6000NPB	Unswitched + Neon	Polished Brass
FP6000NPL	Unswitched + Neon	Pearl



20A SWITCHES

- Double pole switches
- Minimum mounting box depth: 25mm



Code	Model	Finish
FP8341BC	Switched	Brushed Chrome
FP8341GM	Switched	Gunmetal
FP8341PB	Switched	Polished Brass
FP8341PL	Switched	Pearl
FP8341BB	Switched	Brushed Brass
FP8341PC	Switched	Polished Chrome

Code	Model	Finish
FP8341FBC	Switched + Neon + Flex Outlet (Front)	Brushed Chrome
FP8341FGM	Switched + Neon + Flex Outlet (Front)	Gunmetal
FP8341FPB	Switched + Neon + Flex Outlet (Front)	Polished Brass
FP8341FPL	Switched + Neon + Flex Outlet (Front)	Pearl
FP8341FBB	Switched + Neon + Flex Outlet (Front)	Brushed Brass
FP8341FPC	Switched + Neon + Flex Outlet (Front)	Polished Chrome



Code	Model	Finish
FP8341NBC	Switched + Neon	Brushed Chrome
FP8341NGM	Switched + Neon	Gunmetal
FP8341NPB	Switched + Neon	Polished Brass

Code	Model	Finish
FP8341NPL	Switched + Neon	Pearl
FP8341NBB	Switched + Neon	Brushed Brass
FP8341NPC	Switched + Neon	Polished Chrome



45A COOKER SWITCHES

- Double pole switches
- Minimum mounting box depth: 47mm
- Neon indicator



Code	Finish	Size
FP8331NBC	Brushed Chrome	Double
FP8331NGM	Gunmetal	Double
FP8331NPB	Polished Brass	Double
FP8331NPL	Pearl	Double
FP8331NBB	Brushed Brass	Double
FP8331NPC	Polished Chrome	Double



Code	Finish	Size
FP8332NBC	Brushed Chrome	Double
FP8332NGM	Gunmetal	Double
FP8332NPB	Polished Brass	Double
FP8332NPL	Pearl	Double
FP8332NBB	Brushed Brass	Double
FP8332NPC	Polished Chrome	Double

45A COOKER SWITCH AND SOCKET WITH NEONS

- Double pole switches
- 13A switched socket
- Minimum mounting box depth: 47mm

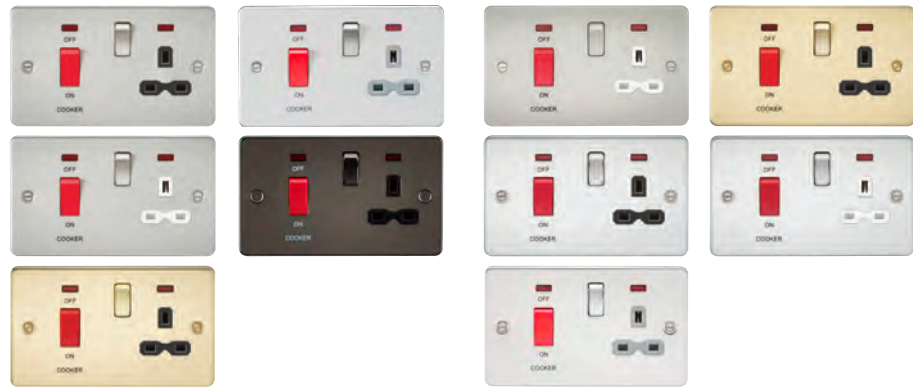

Code	Finish	Insert
FPR8333NBC	Brushed Chrome	Black
FPR8333NBCG	Brushed Chrome	Grey
FPR8333NBCW	Brushed Chrome	White
FPR8333NGM	Gunmetal	Black
FPR8333NPB	Polished Brass	Black

Code	Finish	Insert
FPR8333NPLW	Pearl	White
FPR8333NBB	Brushed Brass	Black
FPR8333NPC	Polished Chrome	Black
FPR8333NPCW	Polished Chrome	White
FPR8333NPCG	Polished Chrome	Grey



TELEPHONE SOCKETS

- Minimum mounting box depth: 25mm



Code	Model	Finish
FP7300BC	Master	Brushed Chrome
FP7300GM	Master	Gunmetal
FP7300PB	Master	Polished Brass
FP7300PL	Master	Pearl
FP7300BB	Master	Brushed Brass
FP7300PC	Master	Polished Chrome

Code	Model	Finish
FP7400BC	Extension	Brushed Chrome
FP7400GM	Extension	Gunmetal
FP7400PB	Extension	Polished Brass
FP7400PL	Extension	Pearl
FP7400BB	Extension	Brushed Brass
FP7400PC	Extension	Polished Chrome

TV OUTLET

- Minimum mounting box depth: 25mm



Code	Model	Finish
FP0100BC	Non-Isolated	Brushed Chrome
FP0100GM	Non-Isolated	Gunmetal
FP0100PB	Non-Isolated	Polished Brass
FP0100PL	Non-Isolated	Pearl
FP0100BB	Non-Isolated	Brushed Brass
FP0100PC	Non-Isolated	Polished Chrome

NETWORK OUTLETS

- UTP CAT5e
- Minimum mounting box depth: 35mm



Code	Model	Finish
FPRJ45BC	RJ45	Brushed Chrome
FPRJ45GM	RJ45	Gunmetal
FPRJ45PB	RJ45	Polished Brass
FPRJ45PL	RJ45	Pearl
FPRJ45BB	RJ45	Brushed Brass
FPRJ45PC	RJ45	Polished Chrome

DIPLEX OUTLET

- Minimum mounting box depth: 35mm



Code	Model	Finish
FP0160BC	Diplex	Brushed Chrome
FP0160GM	Diplex	Gunmetal
FP0160PB	Diplex	Polished Brass
FP0160PL	Diplex	Pearl
FP0160BB	Diplex	Brushed Brass
FP0160PC	Diplex	Polished Chrome

SAT TV OUTLET

- Minimum mounting box depth: 25mm



Code	Model	Finish
FP0150BC	Non-Isolated	Brushed Chrome
FP0150GM	Non-Isolated	Gunmetal
FP0150PB	Non-Isolated	Polished Brass
FP0150PL	Non-Isolated	Pearl
FP0150BB	Non-Isolated	Brushed Brass
FP0150PC	Non-Isolated	Polished Chrome

BLANKING PLATES



Code	Size	Finish
FP8350BC	1G	Brushed Chrome
FP8350GM	1G	Gunmetal
FP8350PB	1G	Polished Brass
FP8350PL	1G	Pearl
FP8350BB	1G	Brushed Brass
FP8350PC	1G	Polished Chrome

TV AND SAT TV OUTLET

- Minimum mounting box depth: 25mm



Code	Model	Finish
FP0140BC	Isolated	Brushed Chrome
FP0140GM	Isolated	Gunmetal
FP0140PB	Isolated	Polished Brass
FP0140PL	Isolated	Pearl
FP0140BB	Isolated	Brushed Brass
FP0140PC	Isolated	Polished Chrome

Code	Size	Finish
FP8360BC	2G	Brushed Chrome
FP8360GM	2G	Gunmetal
FP8360PB	2G	Polished Brass
FP8360PL	2G	Pearl
FP8360BB	2G	Brushed Brass
FP8360PC	2G	Polished Chrome



MODULAR FRAMES

- For use with 25mm x 50mm and/or 50mm x 50mm euro modules



Code	Size	Finish
FP1GBC	1 Module	Brushed Chrome
FP1GGM	1 Module	Gunmetal
FP1GPB	1 Module	Polished Brass

Code	Size	Finish
FP1GPL	1 Module	Pearl
FP1GBB	1 Module	Brushed Brass
FP1GPC	1 Module	Polished Chrome



Modular Inserts available on page 155



Code	Size	Finish
FP2GBC	1-2 Modules	Brushed Chrome
FP2GGM	1-2 Modules	Gunmetal
FP2GPB	1-2 Modules	Polished Brass
FP2GPL	1-2 Modules	Pearl
FP2GBB	1-2 Modules	Brushed Brass
FP2GPC	1-2 Modules	Polished Chrome

Code	Size	Finish
FP4GBC	2-4 Modules	Brushed Chrome
FP4GGM	2-4 Modules	Gunmetal
FP4GPB	2-4 Modules	Polished Brass
FP4GPL	2-4 Modules	Pearl
FP4GBB	2-4 Modules	Brushed Brass
FP4GPC	2-4 Modules	Polished Chrome



To indicate preferred finish, replace xx with PC (polished chrome) or BC (brushed chrome)

GRID FACEPLATES

- Requires grid mounting frame (sold separately)
- For use with Knightsbridge grid accessories only

Code	Size
GDFP001xx	1G
GDFP002xx	2G
GDFP003xx	3G
GDFP004xx	4G
GDFP006xx	6G
GDFP008xx	8G
GDFP009xx	9G
GDFP012xx	12G

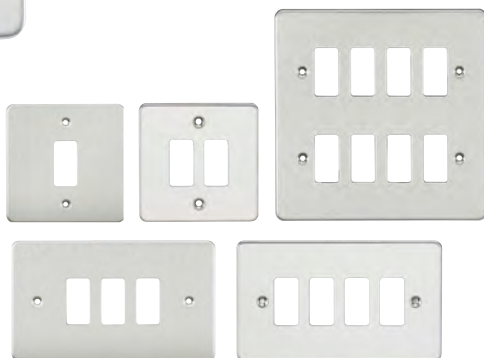

GRID MOUNTING FRAMES

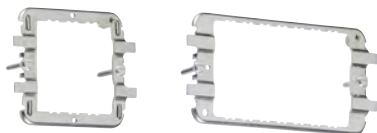

Code	Size
GDF001F	1-2G
GDF002F	3-4G

ELECTRICAL SCREWS

- Flat-head - slotted
- Countersunk



Code	Model	Qty
C-SCREW50B	50mm Brass	100
C-SCREW50N	50mm Nickel	100
C-SCREW50BK	50mm Black Nickel/Gunmetal	100



20AX GRID SWITCH MODULES



Code	Model
------	-------

GDM001xx	2-Way SP
----------	----------

GDM002xx	DP
----------	----

GDM003xx	DP + LED Indicator
----------	--------------------

GDM004xx	2-Way SP (Centre-Off)
----------	-----------------------

GDM005xx	Intermediate
----------	--------------

GDM006xx	2-Way SP Retractive (Marked "PRESS")
----------	---

CREATE 2G
INTERMEDIATE
SWITCHES WITH
GDM005xx



20AX GRID KEY SWITCH MODULES

- Supplied with test key



Code	Model
------	-------

GDM007xx	2-Way SP (Marked "EMG LTG TEST")
----------	----------------------------------

GDM008xx	DP (Marked "EMG LTG TEST")
----------	----------------------------

GDM009xx	2-Way SP
----------	----------

GDM010xx	DP
----------	----

GDKEY	Spare Key
-------	-----------

GRID TRAILING-EDGE DIMMER MODULES

- 10-200W incandescent | 10-100W LED



Code	Model
------	-------

GDM014xx	1-Way Trailing-Edge Dimmer (Press)
----------	------------------------------------

GDM200xx	2-Way Trailing-Edge Dimmer (Rotary)
----------	-------------------------------------



To indicate preferred finish, replace xx with PC (polished chrome) or BC (brushed chrome)

GRID DUMMY DIMMER MODULE

- Push on/off function only
- Ideal for situations where you require one position to look like a dimmer but act like a switch



Code	Model
GDM022xx	6A 2-Way

GRID ROCKER COVERS

- Easy to install
- Replace an existing rocker with an engraved version indicating the appliance it refers to



Code	Model	
GDB01Lxx	Boiler	
GDB00STxx	Fan Boost	NEW
GDCOFFxx	Coffee Machine	NEW
GDCOOKxx	Cooker Hood	
GDDISHxx	Dishwasher	
GDFANxx	Fan	
GDFREEZERxx	Freezer	NEW
GDFRIDGExx	Fridge	NEW
GDFRIDxx	Fridge Freezer	
GDHOBxx	Hob	
GDMICROxx	Microwave	
GDOVENxx	Oven	
GDDRYxx	Tumble Dryer	
GDWARMxx	Warming Drawer	NEW
GDWASHxx	Washing Machine	
GDWASTExx	Waste Disposal	NEW
GDWINExx	Wine Cooler	NEW

10A GRID FAN ISOLATOR MODULES

- Triple pole
- Requires single grid position only



Code	Model
GDM020xx	Fan Isolator Switch Module
GDM021xx	Fan Isolator Key Switch Module (Supplied with Test Key)

MISCELLANEOUS GRID MODULES



Code	Model
GDM011xx	Fuse Holder (13A)
GDM012xx	Flex Outlet (Max. 10mm)
GDM013xx	Blank
GDM017	Indicator - Green
GDM018	Indicator - Red
GDM019	Indicator - Orange

GRID DUAL USB CHARGER MODULE

- Requires two grid positions



Code	Model
GDM016xx	Dual USB Charger Module



METAL DECORATIVE SWITCHES & SOCKETS SCREWLESS

Now available in 8 stunning finishes, with screwless flat plate ultra slim profile design. Very easy to install and the perfect upgrade for any environment

13A 2G Sockets	92
13A 2G USB Sockets (inc. FASTCHARGE) / Phone Holder	93 - 97
13A 1G Sockets	98
13A 1G USB Sockets (inc. FASTCHARGE)	99
1G Quad USB Charger Outlet / Bluetooth Speaker	100
Shaver Sockets	101
Round Pin Sockets / Fan Isolator Switches	102
1G Touchless Switches / 10AX Switches	103 - 105
10AX Toggle Switches	106
Dimmers	108 - 109
Key Card Switch	110
Fused Spur Units	111 - 112
20A Switches	113
45A Cooker Switches and Sockets	114 - 115
Plinth Lights / Media Outlets	116 - 118
Blanking Plates	119
Modular Frames	120 - 121
Multimedia Combination Faceplates	122 - 129
Grid Wiring Accessories	130 - 132

COLOUR MATCHING

Matching metal rockers with no surround

DOUBLE POLE SWITCHES

On selected products for additional safety

LONG LASTING

Robust full metal housing

UNIQUE SOCKET DESIGN

Socket completely concealed by plug once inserted

LOW PROFILE DESIGN

Projection of just 4.3mm (including gasket)

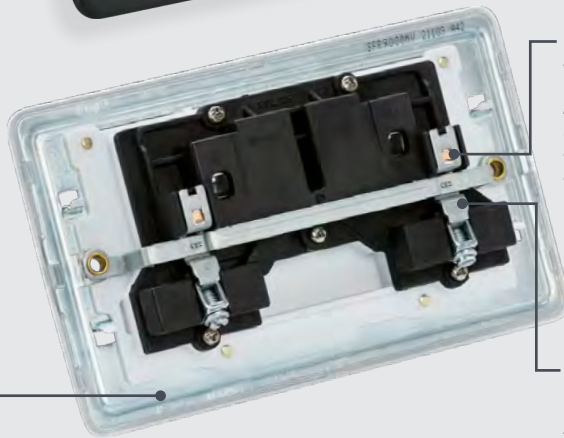

CAPTIVE TERMINALS

Appropriate terminal capacities and captive terminals to prevent screws falling out

HIGH INTEGRITY EARTHING

Twin earth terminals where appropriate

INTEGRATED MOISTURE GASKET

Prevents any moisture transfer to decorative front plate



15 YEAR WARRANTY*

*2 years on electronic products

DIMENSIONS*

Single plate: 87.5mm x 87.5mm
Double plate: 87.5mm x 147.5mm
Projection: 4.3mm

*Unless otherwise stated



Only high-quality imported US ICs and USB Controllers are used in this range, ensuring trouble-free charging and longevity for hospitality areas

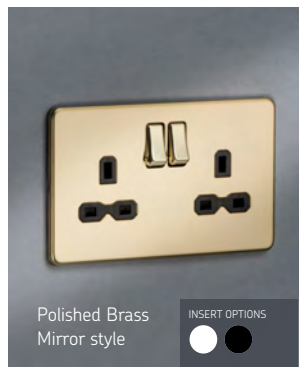
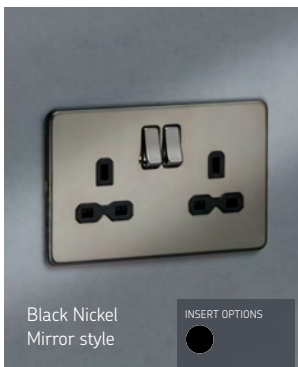
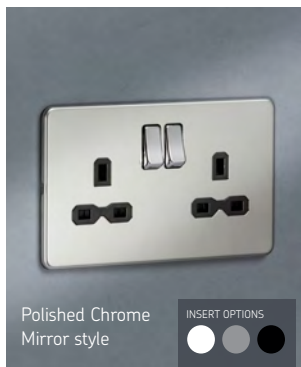
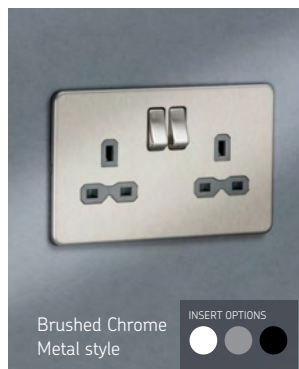
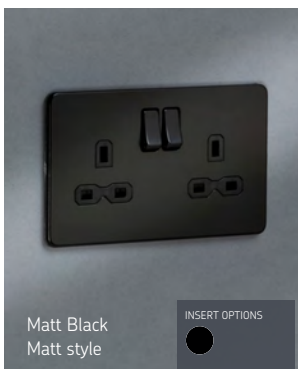
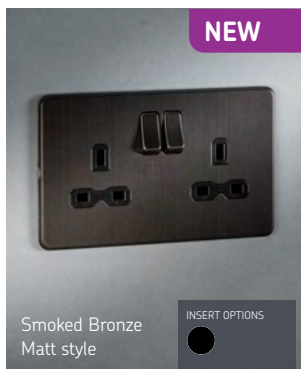
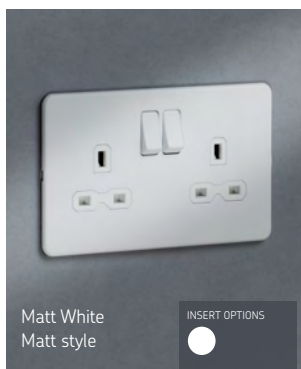

FINISH OPTIONS



SFR9000AT

13A 2G DP SWITCHED SOCKETS

- Twin earth
- Minimum mounting box depth: 25mm



Code	Finish	Insert
SFR9000AT	Anthracite	Black NEW
SFR9000BC	Brushed Chrome	Black
SFR9000BCG	Brushed Chrome	Grey
SFR9000BCW	Brushed Chrome	White
SFR9000BN	Black Nickel	Black
SFR9000MB	Matt Black (Chrome Rockers)	Black
SFR9000MBB	Matt Black	Black

Code	Finish	Insert
SFR9000MW	Matt White	White
SFR9000PB	Polished Brass	Black
SFR9000PBW	Polished Brass	White
SFR9000PC	Polished Chrome	Black
SFR9000PCG	Polished Chrome	Grey
SFR9000PCW	Polished Chrome	White
SFR9000SB	Smoked Bronze	Black NEW



SFR9224MBB

13A 2G SWITCHED SOCKETS WITH USB

- Twin earth
- Minimum mounting box depth: 25-35mm (dependent on wiring conditions)



Code	Finish	Insert
SFR9224AT	Anthracite	Black NEW
SFR9224BC	Brushed Chrome	Black
SFR9224BCG	Brushed Chrome	Grey
SFR9224BCW	Brushed Chrome	White
SFR9224BN	Black Nickel	Black
SFR9224MB	Matt Black (Chrome Rockers)	Black
SFR9224MBB	Matt Black	Black

Code	Finish	Insert
SFR9224MW	Matt White	White
SFR9224PB	Polished Brass	Black
SFR9224PBW	Polished Brass	White
SFR9224PC	Polished Chrome	Black
SFR9224PCG	Polished Chrome	Grey
SFR9224PCW	Polished Chrome	White
SFR9224SB	Smoked Bronze	Black NEW



13A 2G DP SWITCHED SOCKETS WITH FASTCHARGE USB

- FASTCHARGE USB-C port compatible with QC2.0/QC3.0 and USB-PD
- FASTCHARGE USB-A port compatible with QC2.0/QC3.0
- Capable of delivering 0-50% charge in under 30 mins with compatible phones
- 80% faster than a standard 5V DC 2A charger
- Compatible with Android based devices supporting QC2.0/QC3.0 and USB-PD (via USB-C port only)
- Compatible with Apple devices supporting USB-PD (iPhone 8 and above, require certified Lightning to USB-C charge/sync cable)



Code	Finish	Insert
SFR9909AT	Anthracite	Black NEW
SFR9909BC	Brushed Chrome	Black NEW
SFR9909BCG	Brushed Chrome	Grey NEW
SFR9909BCW	Brushed Chrome	White NEW

Code	Finish	Insert
SFR9909MBB	Matt Black	Black NEW
SFR9909MW	Matt White	White NEW
SFR9909SB	Smoked Bronze	Black NEW

2G FLIP-DOWN PHONE HOLDER

- Flip-down phone holder for use with double switched sockets with USB charging facility
- Two-piece install - no need to remove socket from wall
- Sits behind the existing double switched socket
- Fold down shelf for supporting your device whilst charging - folds up when not in use

Code	Finish
2GPHBK	Black
2GPHGY	Grey
2GPHW	White



13A SWITCHED SOCKET WITH DUAL USB CHARGER AND BLUETOOTH SPEAKER

- 3W RMS bluetooth speaker
- Minimum mounting box depth: 25mm-35mm (dependent on wiring conditions)

Code	Finish	Insert
SFR9905BC	Brushed Chrome	Black
SFR9905BCG	Brushed Chrome	Grey
SFR9905BCW	Brushed Chrome	White
SFR9905MW	Matt White	White
SFR9905MBB	Matt Black	Black

FAST CHARGE



**CAPABLE OF DELIVERING 0-50% CHARGE
IN UNDER 30 MINUTES***

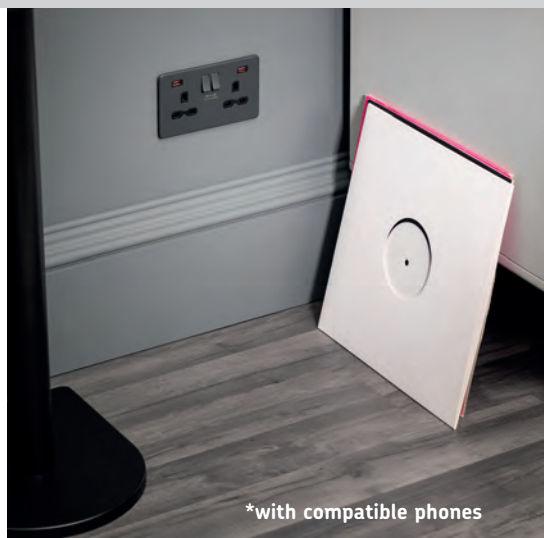

*with compatible phones



13A 2G SWITCHED SOCKET WITH DUAL USB CHARGER AND CHARGING INDICATORS

- Charging indicators: red (charging), green (charged)
- Twin earth
- Minimum mounting box depth: 25-35mm (dependent on wiring conditions)



Code	Finish	Insert
SFR9904NBC	Brushed Chrome	Black
SFR9904NBCG	Brushed Chrome	Grey
SFR9904NBCW	Brushed Chrome	White

Code	Finish	Insert
SFR9904NMBB	Matt Black	Black
SFR9904NMW	Matt White	White

45A SWITCH AND SOCKET WITH DUAL USB CHARGER

- Double pole switch
- 13A switched socket
- Minimum mounting box depth: 47mm



Code	Finish	Insert
SFR8333UAT	Anthracite	Black NEW
SFR8333UBC	Brushed Chrome	Black
SFR8333UBCG	Brushed Chrome	Grey
SFR8333UBCW	Brushed Chrome	White

Code	Finish	Insert
SFR8333UMB	Matt Black	Black
SFR8333UMW	Matt White	White
SFR8333USB	Smoked Bronze	Black NEW



13A SWITCHED SOCKET WITH QUAD USB CHARGER

- 3 ports share 3A
- 1 port dedicated 2.1A
- Minimum mounting box depth: 25-35mm (dependent on wiring conditions)



Code	Finish	Insert
SFR7USB4AT	Anthracite	Black NEW
SFR7USB4BC	Brushed Chrome	Black
SFR7USB4BCG	Brushed Chrome	Grey
SFR7USB4BCW	Brushed Chrome	White
SFR7USB4BN	Black Nickel	Black
SFR7USB4MB	Matt Black (Chrome Rocker)	Black
SFR7USB4MBB	Matt Black	Black

Code	Finish	Insert
SFR7USB4MW	Matt White	White
SFR7USB4PB	Polished Brass	Black
SFR7USB4PBW	Polished Brass	White
SFR7USB4PC	Polished Chrome	Black
SFR7USB4PCG	Polished Chrome	Grey
SFR7USB4PCW	Polished Chrome	White
SFR7USB4SB	Smoked Bronze	Black NEW



13A 1G DP SOCKETS

- Minimum mounting box depth: 25mm
- Twin earth



Code	Finish	Insert
SFR7000AT	Anthracite	Black NEW
SFR7000BC	Brushed Chrome	Black
SFR7000BCG	Brushed Chrome	Grey
SFR7000BCW	Brushed Chrome	White
SFR7000BN	Black Nickel	Black
SFR7000MB	Matt Black (Chrome Rocker)	Black
SFR7000MBB	Matt Black	Black

Code	Finish	Insert
SFR7000MW	Matt White	White
SFR7000PB	Polished Brass	Black
SFR7000PBW	Polished Brass	White
SFR7000PC	Polished Chrome	Black
SFR7000PCG	Polished Chrome	Grey
SFR7000PCW	Polished Chrome	White
SFR7000SB	Smoked Bronze	Black NEW



13A 1G SOCKETS WITH USB

- Minimum mounting box depth: 25-35mm (dependent on wiring conditions)



Code	Finish	Insert
SFR9124AT	Anthracite	Black NEW
SFR9124BC	Brushed Chrome	Black NEW
SFR9124BCG	Brushed Chrome	Grey NEW
SFR9124BCW	Brushed Chrome	White NEW
SFR9124BN	Black Nickel	Black NEW
SFR9124MB	Matt Black (Chrome Rocker)	Black NEW
SFR9124MBB	Matt Black	Black NEW

Code	Finish	Insert
SFR9124MW	Matt White	White NEW
SFR9124PB	Polished Brass	Black NEW
SFR9124PBW	Polished Brass	White NEW
SFR9124PC	Polished Chrome	Black NEW
SFR9124PCG	Polished Chrome	Grey NEW
SFR9124PCW	Polished Chrome	White NEW
SFR9124SB	Smoked Bronze	Black NEW

13A 1G SOCKETS WITH FASTCHARGE USB

- FASTCHARGE USB-C port compatible with QC2.0/QC3.0 and USB-PD
- FASTCHARGE USB-A port compatible with QC2.0/QC3.0
- Capable of delivering 0-50% charge in under 30 mins with compatible phones
- 80% faster than a standard 5V DC 2A charger
- Compatible with Android based devices supporting QC2.0/QC3.0 and USB-PD (via USB-C port only)
- Compatible with Apple devices supporting USB-PD (iPhone 8 and above, require certified Lightning to USB-C charge/sync cable)



Code	Finish	Insert
SFR9919AT	Anthracite	Black NEW
SFR9919BC	Brushed Chrome	Black NEW
SFR9919MBB	Matt Black	Black NEW

Code	Finish	Insert
SFR9919MW	Matt White	White NEW
SFR9919SB	Smoked Bronze	Black NEW



1GSBXX/2GSBXX
AVAILABLE ON PAGE 179



QUAD USB CHARGER OUTLET

- 3 ports share 3A
- 1 port dedicated 2.1A
- Minimum mounting box depth: 25-35mm (dependent on wiring conditions)



Code	Finish	Insert
SFQUADAT	Anthracite	Black NEW
SFQUADBC	Brushed Chrome	Black
SFQUADBCG	Brushed Chrome	Grey
SFQUADBCW	Brushed Chrome	White
SFQUADBN	Black Nickel	Black
SFQUADMB	Matt Black	Black
SFQUADMW	Matt White	White

Code	Finish	Insert
SFQUADPB	Polished Brass	Black
SFQUADPBW	Polished Brass	White
SFQUADPC	Polished Chrome	Black
SFQUADPCG	Polished Chrome	Grey
SFQUADPCW	Polished Chrome	White
SFQUADSB	Smoked Bronze	Black NEW

FLUSH MOUNT BLUETOOTH SPEAKER

- 3W RMS bluetooth speaker
- Minimum mounting box depth: 35mm



Code	Finish
SFBLUEBC	Brushed Chrome
SFBLUEMW	Matt White

DUAL VOLTAGE SHAVER SOCKETS

- 115/230V 20VA rated
- Minimum mounting box depth: 47mm



Code	Finish	Insert
SF8900AT	Anthracite	Black NEW
SF8900BC	Brushed Chrome	Black
SF8900BCG	Brushed Chrome	Grey
SF8900BCW	Brushed Chrome	White
SF8900BN	Black Nickel	Black
SF8900MB	Matt Black	Black
SF8900MW	Matt White	White

Code	Finish	Insert
SF8900PB	Polished Brass	Black
SF8900PBW	Polished Brass	White
SF8900PC	Polished Chrome	Black
SF8900PCG	Polished Chrome	Grey
SF8900PCW	Polished Chrome	White
SF8900SB	Smoked Bronze	Black NEW



5A ROUND PIN SOCKETS

- 5A rated
- Minimum mounting box depth: 25mm



Code	Finish	Insert
SF5AAT	Anthracite	Black NEW
SF5ABC	Brushed Chrome	Black
SF5ABCG	Brushed Chrome	Grey
SF5ABCW	Brushed Chrome	White
SF5ABN	Black Nickel	Black
SF5AMB	Matt Black	Black
SF5AMW	Matt White	White

Code	Finish	Insert
SF5APB	Polished Brass	Black
SF5APBW	Polished Brass	White
SF5APC	Polished Chrome	Black
SF5APCG	Polished Chrome	Grey
SF5APCW	Polished Chrome	White
SF5ASB	Smoked Bronze	Black NEW

10AX FAN ISOLATOR SWITCHES

- Triple pole
- Minimum mounting box depth: 16mm



Code	Finish
SF1100AT	Anthracite NEW
SF1100BC	Brushed Chrome
SF1100BN	Black Nickel
SF1100MB	Matt Black (Chrome Rocker)
SF1100MBB	Matt Black

Code	Finish
SF1100MW	Matt White
SF1100PB	Polished Brass
SF1100PC	Polished Chrome
SF1100SB	Smoked Bronze NEW

1G TOUCHLESS SWITCHES

- Gesture controlled (on/off)
- Sensor detection range: 3cm

- Max. load: 500W resistive / 200W inductive / 100W LED
- Minimum mounting box depth: 25mm
- Requires neutral



HELPS REDUCE
THE SPREAD OF GERMS
AND BACTERIA

Code	Finish	Model	
SFTS1AT	Anthracite	2-Way	NEW
SFTS1BC	Brushed Chrome	2-Way	NEW
SFTS1BN	Black Nickel	2-Way	NEW
SFTS1MB	Matt Black	2-Way	NEW

Code	Finish	Model	
SFTS1MW	Matt White	2-Way	NEW
SFTS1PC	Polished Chrome	2-Way	NEW
SFTS1SB	Smoked Bronze	2-Way	NEW

10AX SWITCHES

- Minimum mounting box depth: 16mm



Code	Size	Model	Finish	
SF1200AT	1G	Intermediate	Anthracite	NEW
SF1200BC	1G	Intermediate	Brushed Chrome	
SF1200BN	1G	Intermediate	Black Nickel	
SF1200MB	1G	Intermediate	Matt Black (Chrome Rocker)	
SF1200MBB	1G	Intermediate	Matt Black	
SF1200MW	1G	Intermediate	Matt White	
SF1200PB	1G	Intermediate	Polished Brass	
SF1200PC	1G	Intermediate	Polished Chrome	
SF1200SB	1G	Intermediate	Smoked Bronze	NEW

Code	Size	Model	Finish	
SF2000AT	1G	2-Way	Anthracite	NEW
SF2000BC	1G	2-Way	Brushed Chrome	
SF2000BN	1G	2-Way	Black Nickel	
SF2000MB	1G	2-Way	Matt Black (Chrome Rocker)	
SF2000MBB	1G	2-Way	Matt Black	
SF2000MW	1G	2-Way	Matt White	
SF2000PB	1G	2-Way	Polished Brass	
SF2000PC	1G	2-Way	Polished Chrome	
SF2000SB	1G	2-Way	Smoked Bronze	NEW



Code	Size	Model	Finish
SF3000AT	2G	2-Way	Anthracite NEW
SF3000BC	2G	2-Way	Brushed Chrome
SF3000BN	2G	2-Way	Black Nickel
SF3000MB	2G	2-Way	Matt Black (Chrome Rockers)
SF3000MBB	2G	2-Way	Matt Black

Code	Size	Model	Finish
SF3000MW	2G	2-Way	Matt White
SF3000PB	2G	2-Way	Polished Brass
SF3000PC	2G	2-Way	Polished Chrome
SF3000SB	2G	2-Way	Smoked Bronze NEW



Code	Size	Model	Finish
SF4000AT	3G	2-Way	Anthracite NEW
SF4000BC	3G	2-Way	Brushed Chrome
SF4000BN	3G	2-Way	Black Nickel
SF4000MB	3G	2-Way	Matt Black (Chrome Rockers)
SF4000MBB	3G	2-Way	Matt Black

Code	Size	Model	Finish
SF4000MW	3G	2-Way	Matt White
SF4000PB	3G	2-Way	Polished Brass
SF4000PC	3G	2-Way	Polished Chrome
SF4000SB	3G	2-Way	Smoked Bronze NEW

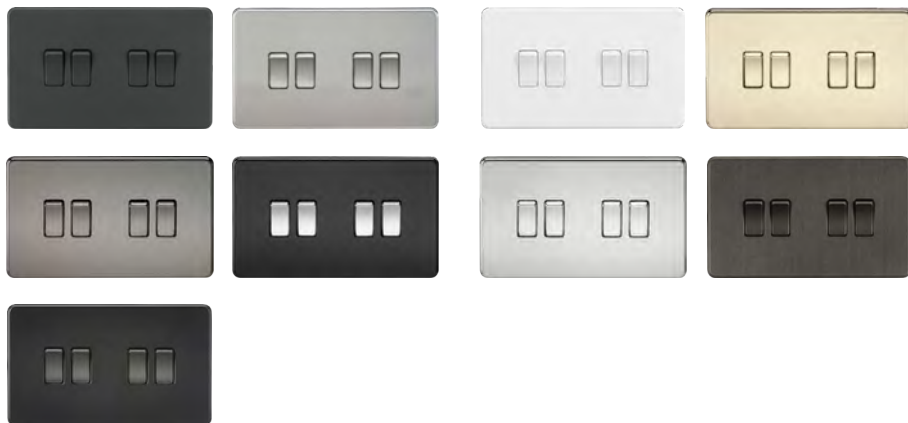

Code	Size	Model	Finish	
SF4100AT	4G	2-Way	Anthracite	NEW
SF4100BC	4G	2-Way	Brushed Chrome	
SF4100BN	4G	2-Way	Black Nickel	
SF4100MB	4G	2-Way	Matt Black (Chrome Rockers)	
SF4100MBB	4G	2-Way	Matt Black	

Code	Size	Model	Finish	
SF4100MW	4G	2-Way	Matt White	
SF4100PB	4G	2-Way	Polished Brass	
SF4100PC	4G	2-Way	Polished Chrome	
SF4100SB	4G	2-Way	Smoked Bronze	NEW

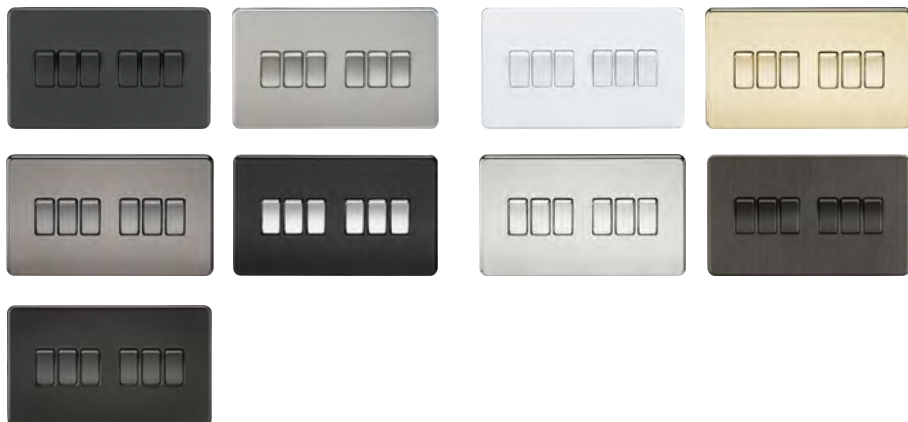

Code	Size	Model	Finish	
SF4200AT	6G	2-Way	Anthracite	NEW
SF4200BC	6G	2-Way	Brushed Chrome	
SF4200BN	6G	2-Way	Black Nickel	
SF4200MB	6G	2-Way	Matt Black (Chrome Rockers)	
SF4200MBB	6G	2-Way	Matt Black	

Code	Size	Model	Finish	
SF4200MW	6G	2-Way	Matt White	
SF4200PB	6G	2-Way	Polished Brass	
SF4200PC	6G	2-Way	Polished Chrome	
SF4200SB	6G	2-Way	Smoked Bronze	NEW



10AX TOGGLE SWITCHES

• Minimum mounting box depth: 16mm



Code	Size	Model	Finish
SF12TOGBC	1G	Intermediate	Brushed Chrome
SF12TOGBN	1G	Intermediate	Black Nickel
SF12TOGPC	1G	Intermediate	Polished Chrome
SF12TOGPB	1G	Intermediate	Polished Brass

Code	Size	Model	Finish
SF1TOGBC	1G	2-Way	Brushed Chrome
SF1TOGBN	1G	2-Way	Black Nickel
SF1TOGPC	1G	2-Way	Polished Chrome
SF1TOGPB	1G	2-Way	Polished Brass



Code	Size	Model	Finish
SF2TOGBC	2G	2-Way	Brushed Chrome
SF2TOGBN	2G	2-Way	Black Nickel
SF2TOGPC	2G	2-Way	Polished Chrome
SF2TOGPB	2G	2-Way	Polished Brass



Code	Size	Model	Finish
SF3TOGBC	3G	2-Way	Brushed Chrome
SF3TOGBN	3G	2-Way	Black Nickel
SF3TOGPC	3G	2-Way	Polished Chrome
SF3TOGPB	3G	2-Way	Polished Brass



Code	Size	Model	Finish
SF4TOGBC	4G	2-Way	Brushed Chrome
SF4TOGBN	4G	2-Way	Black Nickel
SF4TOGPC	4G	2-Way	Polished Chrome
SF4TOGPB	4G	2-Way	Polished Brass



KEEP UP TO DATE WITH NEW PRODUCTS, SPECIAL OFFERS, AND MORE



Knightsbridge

 @KnightsbridgeML

 @Knightsbridgema

 @Knightsbridge

 @Knightsbridgema



TRAILING-EDGE DIMMERS

- 10-200W incandescent | 5-150W LED
- Minimum mounting box depth: 25mm



Code	Size	Model	Finish
SF2181AT	1G	2-Way	Anthracite NEW
SF2181BC	1G	2-Way	Brushed Chrome
SF2181BN	1G	2-Way	Black Nickel
SF2181MB	1G	2-Way	Matt Black (Chrome Cap)
SF2181MBB	1G	2-Way	Matt Black

Code	Size	Model	Finish
SF2181MW	1G	2-Way	Matt White
SF2181PB	1G	2-Way	Polished Brass
SF2181PC	1G	2-Way	Polished Chrome
SF2181SB	1G	2-Way	Smoked Bronze NEW



Code	Size	Model	Finish
SF2182AT	2G	2-Way	Anthracite NEW
SF2182BC	2G	2-Way	Brushed Chrome
SF2182BN	2G	2-Way	Black Nickel
SF2182MB	2G	2-Way	Matt Black (Chrome Caps)
SF2182MBB	2G	2-Way	Matt Black

Code	Size	Model	Finish
SF2182MW	2G	2-Way	Matt White
SF2182PB	2G	2-Way	Polished Brass
SF2182PC	2G	2-Way	Polished Chrome
SF2182SB	2G	2-Way	Smoked Bronze NEW



Code	Size	Model	Finish	
SF2183AT	3G	2-Way	Anthracite	NEW
SF2183BC	3G	2-Way	Brushed Chrome	
SF2183BN	3G	2-Way	Black Nickel	
SF2183MB	3G	2-Way	Matt Black (Chrome Caps)	
SF2183MBB	3G	2-Way	Matt Black	

Code	Size	Model	Finish	
SF2183MW	3G	2-Way	Matt White	
SF2183PB	3G	2-Way	Polished Brass	
SF2183PC	3G	2-Way	Polished Chrome	
SF2183SB	3G	2-Way	Smoked Bronze	NEW



Code	Size	Model	Finish	
SF2184AT	4G	2-Way	Anthracite	NEW
SF2184BC	4G	2-Way	Brushed Chrome	
SF2184BN	4G	2-Way	Black Nickel	
SF2184MB	4G	2-Way	Matt Black (Chrome Caps)	
SF2184MBB	4G	2-Way	Matt Black	

Code	Size	Model	Finish	
SF2184MW	4G	2-Way	Matt White	
SF2184PB	4G	2-Way	Polished Brass	
SF2184PC	4G	2-Way	Polished Chrome	
SF2184SB	4G	2-Way	Smoked Bronze	NEW



32A KEY CARD SWITCH

- 32A rated
- Backlight arrow to aid activation in darkness
- Minimum mounting box depth: 47mm

Code	Finish
SFCARDBC	Brushed Chrome



FUSED SPUR UNITS

- 13A rated
- Double pole switches where applicable
- Minimum mounting box depth: 25mm



Code	Model	Finish	
SF6000AT	Unswitched	Anthracite	NEW
SF6000BC	Unswitched	Brushed Chrome	
SF6000BN	Unswitched	Black Nickel	
SF6000MB	Unswitched	Matt Black (Chrome Cover)	
SF6000MBB	Unswitched	Matt Black	

Code	Model	Finish	
SF6000MW	Unswitched	Matt White	
SF6000PB	Unswitched	Polished Brass	
SF6000PC	Unswitched	Polished Chrome	
SF6000SB	Unswitched	Smoked Bronze	NEW



Code	Model	Finish	
SF6300AT	Switched	Anthracite	NEW
SF6300BC	Switched	Brushed Chrome	
SF6300BN	Switched	Black Nickel	
SF6300MB	Switched	Matt Black (Chrome Cover + Rocker)	
SF6300MBB	Switched	Matt Black	

Code	Model	Finish	
SF6300MW	Switched	Matt White	
SF6300PB	Switched	Polished Brass	
SF6300PC	Switched	Polished Chrome	
SF6300SB	Switched	Smoked Bronze	NEW



Code	Model	Finish	
SF6300NAT	Switched + Neon	Anthracite	NEW
SF6300NBC	Switched + Neon	Brushed Chrome	
SF6300NBN	Switched + Neon	Black Nickel	
SF6300NMB	Switched + Neon	Matt Black (Chrome Cover + Rocker)	
SF6300NMBB	Switched + Neon	Matt Black	

Code	Model	Finish	
SF6300NMW	Switched + Neon	Matt White	
SF6300NPB	Switched + Neon	Polished Brass	
SF6300NPC	Switched + Neon	Polished Chrome	
SF6300NSB	Switched + Neon	Smoked Bronze	NEW



Code	Model	Finish	
SF6300FAT	Switched + Neon + Flex	Anthracite	NEW
SF6300FBC	Switched + Neon + Flex	Brushed Chrome	NEW
SF6300FBN	Switched + Neon + Flex	Black Nickel	NEW
SF6300FMBB	Switched + Neon + Flex	Matt Black	NEW

Code	Model	Finish	
SF6300FMW	Switched + Neon + Flex	Matt White	NEW
SF6300FPC	Switched + Neon + Flex	Polished Chrome	NEW
SF6300FSB	Switched + Neon + Flex	Smoked Bronze	NEW

20A SWITCHES

- Double pole switches
- Minimum mounting box depth: 25mm



Code	Model	Finish	
SF8341AT	Switched	Anthracite	NEW
SF8341BC	Switched	Brushed Chrome	
SF8341BN	Switched	Black Nickel	
SF8341MB	Switched	Matt Black (Chrome Rocker)	

Code	Model	Finish	
SF8341MBB	Switched	Matt Black	
SF8341MW	Switched	Matt White	
SF8341PB	Switched	Polished Brass	
SF8341PC	Switched	Polished Chrome	
SF8341SB	Switched	Smoked Bronze	NEW



Code	Model	Finish	
SF8341NAT	Switched + Neon	Anthracite	NEW
SF8341NBC	Switched + Neon	Brushed Chrome	
SF8341NBN	Switched + Neon	Black Nickel	
SF8341NMB	Switched + Neon	Matt Black (Chrome Rocker)	

Code	Model	Finish	
SF8341NMBB	Switched + Neon	Matt Black	
SF8341NMW	Switched + Neon	Matt White	
SF8341NPB	Switched + Neon	Polished Brass	
SF8341NPC	Switched + Neon	Polished Chrome	
SF8341NSB	Switched + Neon	Smoked Bronze	NEW



45A COOKER SWITCHES

- Double pole switches
- Minimum mounting box depth: 47mm
- Neon indicators



Code	Size	Finish
SF8331NAT	Single	Anthracite NEW
SF8331NBC	Single	Brushed Chrome
SF8331NBN	Single	Black Nickel
SF8331NMB	Single	Matt Black

Code	Size	Finish
SF8331NMW	Single	Matt White
SF8331NPB	Single	Polished Brass
SF8331NPC	Single	Polished Chrome
SF8331NSB	Single	Smoked Bronze NEW

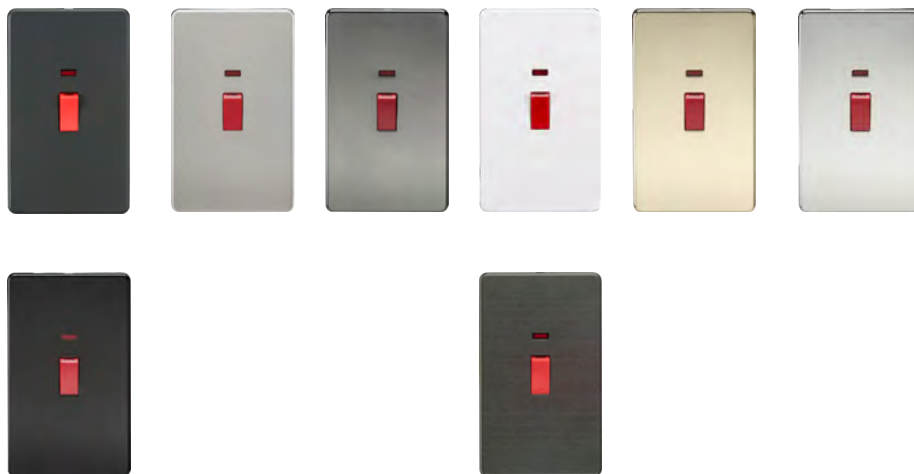

Code	Size	Finish
SF8332NAT	Double	Anthracite NEW
SF8332NBC	Double	Brushed Chrome
SF8332NBN	Double	Black Nickel
SF8332NMB	Double	Matt Black

Code	Size	Finish
SF8332NMW	Double	Matt White
SF8332NPB	Double	Polished Brass
SF8332NPC	Double	Polished Chrome
SF8332NSB	Double	Smoked Bronze NEW

USB MODELS
PAGE 96



45A COOKER SWITCH AND
SOCKET WITH NEONS

- Double pole switches
- 13A switched socket
- Minimum mounting box depth: 47mm

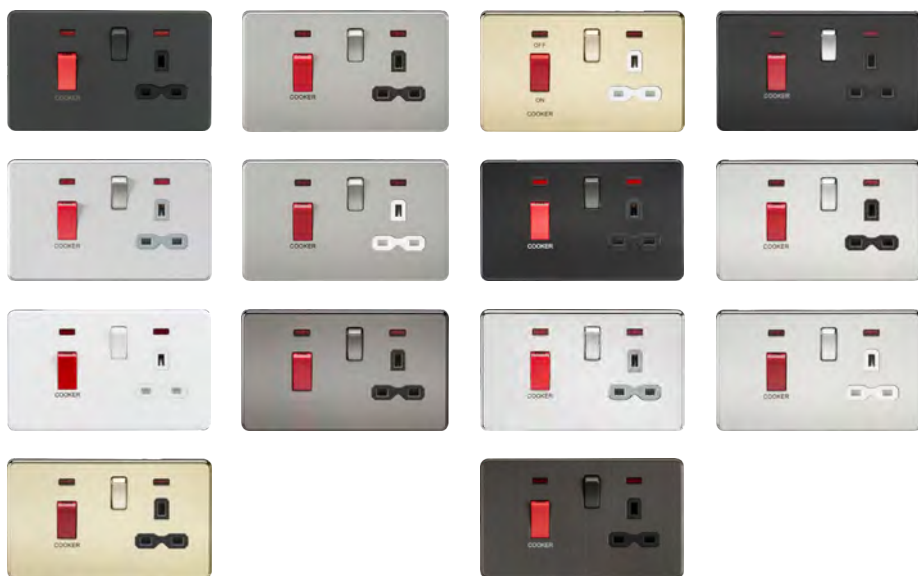

Code	Finish	Insert
SFR8333NAT	Anthracite	Black NEW
SFR8333NBC	Brushed Chrome	Black
SFR8333NBCG	Brushed Chrome	Grey
SFR8333NBCW	Brushed Chrome	White
SFR8333NMW	Matt White	White
SFR8333NBN	Black Nickel	Black
SFR8333NPB	Polished Brass	Black

Code	Finish	Insert
SFR8333NPBW	Polished Brass	White
SFR8333NMBB	Matt Black	Black
SFR8333NMB	Matt Black (Chrome Rocker)	Black
SFR8333NPC	Polished Chrome	Black
SFR8333NPCG	Polished Chrome	Grey
SFR8333NPCW	Polished Chrome	White
SFR8333NSB	Smoked Bronze	Black NEW



LED PLINTH LIGHTS

- Ideal for kitchen plinth lighting or staircases
- Fits standard UK steel back boxes and drylining boxes
- Minimum mounting box depth: 25mm



SURFACE MOUNT BOXES
1GSBxx/2GSBxx
 AVAILABLE ON PAGE 179

Code	Model	Finish
SFPLBC	Cool White 4000K	Brushed Chrome

Code	Model	Finish
SFPLMW	Cool White 4000K	Matt White

TV OUTLET

- Minimum mounting box depth: 25mm



Code	Model	Finish
SF0100AT	Non-isolated	Anthracite NEW
SF0100BC	Non-isolated	Brushed Chrome
SF0100BN	Non-isolated	Black Nickel
SF0100MB	Non-isolated	Matt Black

Code	Model	Finish
SF0100MW	Non-isolated	Matt White
SF0100PB	Non-isolated	Polished Brass
SF0100PC	Non-isolated	Polished Chrome
SF0100SB	Non-isolated	Smoked Bronze NEW

SAT TV OUTLET

- Minimum mounting box depth: 25mm



Code	Model	Finish
SF0150AT	Non-isolated	Anthracite NEW
SF0150BC	Non-isolated	Brushed Chrome
SF0150BN	Non-isolated	Black Nickel
SF0150MB	Non-isolated	Matt Black

Code	Model	Finish
SF0150MW	Non-isolated	Matt White
SF0150PB	Non-isolated	Polished Brass
SF0150PC	Non-isolated	Polished Chrome
SF0150SB	Non-isolated	Smoked Bronze NEW

TV AND SAT TV OUTLET

- Minimum mounting box depth: 25mm



Code	Model	Finish
SF0140AT	Isolated	Anthracite NEW
SF0140BC	Isolated	Brushed Chrome
SF0140BN	Isolated	Black Nickel
SF0140MB	Isolated	Matt Black

Code	Model	Finish
SF0140MW	Isolated	Matt White
SF0140PB	Isolated	Polished Brass
SF0140PC	Isolated	Polished Chrome
SF0140SB	Isolated	Smoked Bronze NEW

TELEPHONE SOCKETS

- Minimum mounting box depth: 25mm



Code	Model	Finish
SF7300AT	Master	Anthracite NEW
SF7300BC	Master	Brushed Chrome
SF7300BN	Master	Black Nickel
SF7300MB	Master	Matt Black

Code	Model	Finish
SF7300MW	Master	Matt White
SF7300PB	Master	Polished Brass
SF7300PC	Master	Polished Chrome
SF7300SB	Master	Smoked Bronze NEW



TELEPHONE SOCKETS

- Minimum mounting box depth: 25mm



Code	Model	Finish	
SF7400AT	Extension	Anthracite	NEW
SF7400BC	Extension	Brushed Chrome	
SF7400BN	Extension	Black Nickel	
SF7400MB	Extension	Matt Black	

Code	Model	Finish	
SF7400MW	Extension	Matt White	
SF7400PB	Extension	Polished Brass	
SF7400PC	Extension	Polished Chrome	
SF7400SB	Extension	Smoked Bronze	NEW

NETWORK OUTLETS

- UTP CAT5e
- Minimum mounting box depth: 35mm



Code	Model	Finish	
SFRJ45AT	RJ45	Smoked Bronze	NEW
SFRJ45BC	RJ45	Brushed Chrome	
SFRJ45BN	RJ45	Black Nickel	
SFRJ45MB	RJ45	Matt Black	

Code	Model	Finish	
SFRJ45MW	RJ45	Matt White	
SFRJ45PB	RJ45	Polished Brass	
SFRJ45PC	RJ45	Polished Chrome	
SFRJ45SB	RJ45	Smoked Bronze	NEW

BLANKING PLATES



Code	Size	Finish
SF8350AT	1G	Anthracite NEW
SF8350BC	1G	Brushed Chrome
SF8350BN	1G	Black Nickel
SF8350MB	1G	Matt Black

Code	Size	Finish
SF8350MW	1G	Matt White
SF8350PB	1G	Polished Brass
SF8350PC	1G	Polished Chrome
SF8350SB	1G	Smoked Bronze NEW



Code	Size	Finish
SF8360AT	2G	Anthracite NEW
SF8360BC	2G	Brushed Chrome
SF8360BN	2G	Black Nickel
SF8360MB	2G	Matt Black

Code	Size	Finish
SF8360MW	2G	Matt White
SF8360PB	2G	Polished Brass
SF8360PC	2G	Polished Chrome
SF8360SB	2G	Smoked Bronze NEW



MODULAR FRAMES

• For use with 25x50mm and/or 50x50mm euro modules (see page 155)



Code	Model	Finish	
SF1GAT	1 Module	Anthracite	NEW
SF1GBC	1 Module	Brushed Chrome	
SF1GBN	1 Module	Black Nickel	
SF1GMB	1 Module	Matt Black	

Code	Model	Finish	
SF1GMW	1 Module	Matt White	
SF1GPB	1 Module	Polished Brass	
SF1GPC	1 Module	Polished Chrome	
SF1GSB	1 Module	Smoked Bronze	NEW



Code	Model	Finish	
SF2GAT	1-2 Modules	Anthracite	NEW
SF2GBC	1-2 Modules	Brushed Chrome	
SF2GBN	1-2 Modules	Black Nickel	
SF2GMB	1-2 Modules	Matt Black	

Code	Model	Finish	
SF2GMW	1-2 Modules	Matt White	
SF2GPB	1-2 Modules	Polished Brass	
SF2GPC	1-2 Modules	Polished Chrome	
SF2GSB	1-2 Modules	Smoked Bronze	NEW

MODULAR SOLUTIONS
PAGE 155





Code	Model	Finish	
SF4GAT	2-4 Modules	Anthracite	NEW
SF4GBC	2-4 Modules	Brushed Chrome	
SF4GBN	2-4 Modules	Black Nickel	
SF4GMB	2-4 Modules	Matt Black	

Code	Model	Finish	
SF4GMW	2-4 Modules	Matt White	
SF4GPB	2-4 Modules	Polished Brass	
SF4GPC	2-4 Modules	Polished Chrome	
SF4GSB	2-4 Modules	Smoked Bronze	NEW



*modules not included

MODULAR SOLUTIONS
PAGE 155



Code	Model	Finish	
SF6GAT	3-6 Modules	Anthracite	NEW
SF6GBC	3-6 Modules	Brushed Chrome	NEW
SF6GBN	3-6 Modules	Black Nickel	NEW
SF6GMB	3-6 Modules	Matt Black	NEW

Code	Model	Finish	
SF6GMW	3-6 Modules	Matt White	NEW
SF6GPB	3-6 Modules	Polished Brass	NEW
SF6GPC	3-6 Modules	Polished Chrome	NEW
SF6GSB	3-6 Modules	Smoked Bronze	NEW

Code	Model
GSK298MM	47mm Galvanised Steel Box for Combination Multimedia Plate
GSK335D	35mm 1G + 2G Galvanised Steel Box

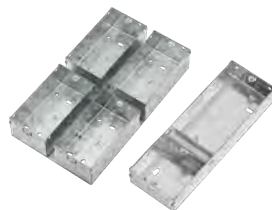



*modules not included



Other colour options are available via special order only

MULTIMEDIA COMBINATION FACEPLATE

Code	Finish	Insert
SFR298AT	Anthracite	Black NEW
SFR298BC	Brushed Chrome	Black NEW
SFR298BCG	Brushed Chrome	Grey NEW
SFR298BCW	Brushed Chrome	White NEW
SFR298MW	Matt White	White NEW
SFR298MBB	Matt Black	Black NEW

Code	Finish	Insert
SFR298PC	Polished Chrome	Black NEW
SFR298PCG	Polished Chrome	Grey NEW
SFR298PCW	Polished Chrome	White NEW
SFR298SB	Smoked Bronze	Black NEW

Code	Model
GSK298MM	47mm Galvanised Steel Box for Combination Multimedia Plate

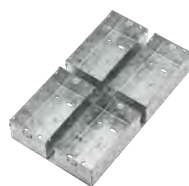

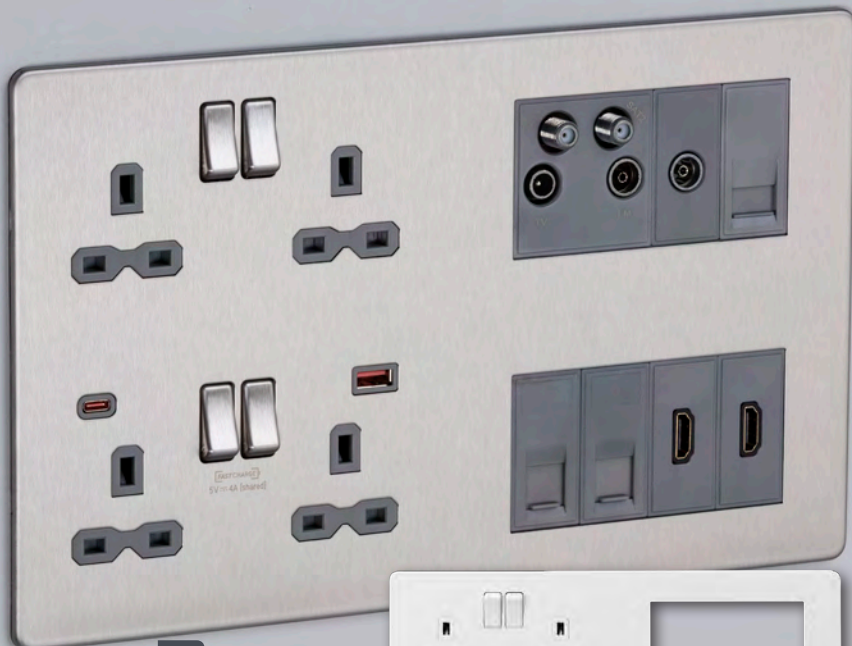

FAST CHARGE

*modules not included



MULTIMEDIA COMBINATION FACEPLATE WITH USB FASTCHARGE A+C

- FASTCHARGE USB-C port compatible with QC2.0/QC3.0 and USB-PD
- FASTCHARGE USB-A port compatible with QC2.0/QC3.0
- Capable of delivering 0-50% charge in under 30 mins with compatible phones
- 80% faster than a standard 5V DC 2A charger
- Compatible with Android based devices supporting QC2.0/QC3.0 and USB-PD (via USB-C port only)
- Compatible with Apple devices supporting USB-PD (iPhone 8 and above, require certified Lightning to USB-C charge/sync cable)



Code	Finish	Insert
SFR998AT	Anthracite	Black NEW
SFR998BC	Brushed Chrome	Black NEW
SFR998BCW	Brushed Chrome	White NEW
SFR998BCG	Brushed Chrome	Grey NEW
SFR998MW	Matt White	White NEW
SFR998MBB	Matt Black	Black NEW

Code	Finish	Insert
SFR998PC	Polished Chrome	Black NEW
SFR998PCG	Polished Chrome	Grey NEW
SFR998PCW	Polished Chrome	White NEW
SFR998SB	Smoked Bronze	Black NEW

Code	Model
GSK298MM	47mm Galvanised Steel Box for Combination Multimedia Plate

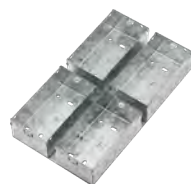



HALF SIZE MULTIMEDIA COMBINATION FACEPLATE

Code	Finish	Insert	
SFR194AT	Anthracite	Black	NEW
SFR194BC	Brushed Chrome	Black	NEW
SFR194BCG	Brushed Chrome	Grey	NEW
SFR194BCW	Brushed Chrome	White	NEW
SFR194MW	Matt White	White	NEW

Code	Finish	Insert	
SFR194MBB	Matt Black	Black	NEW
SFR194PC	Polished Chrome	Black	NEW
SFR194PCG	Polished Chrome	Grey	NEW
SFR194PCW	Polished Chrome	White	NEW
SFR194SB	Smoked Bronze	Black	NEW

Code	Model
GSK194MM	47mm Galvanised Steel Box for Small Combination Multimedia Plate





FASTCHARGE

MODULAR INSERTS
AVAILABLE ON PAGE 155



HALF SIZE MULTIMEDIA COMBINATION FACEPLATE WITH USB FASTCHARGE A+C

- FASTCHARGE USB-C port compatible with QC2.0/QC3.0 and USB-PD
- FASTCHARGE USB-A port compatible with QC2.0/QC3.0
- Capable of delivering 0-50% charge in under 30 mins with compatible phones
- 80% faster than a standard 5V DC 2A charger
- Compatible with Android based devices supporting QC2.0/QC3.0 and USB-PD (via USB-C port only)
- Compatible with Apple devices supporting USB-PD (iPhone 8 and above, require certified Lightning to USB-C charge/sync cable)



Code	Finish	Insert
SFR994AT	Anthracite	Black NEW
SFR994BC	Brushed Chrome	Black NEW
SFR994BCG	Brushed Chrome	Grey NEW
SFR994BCW	Brushed Chrome	White NEW
SFR994MW	Matt White	White NEW

Code	Finish	Insert
SFR994MBB	Matt Black	Black NEW
SFR994PC	Polished Chrome	Black NEW
SFR994PCG	Polished Chrome	Grey NEW
SFR994PCW	Polished Chrome	White NEW
SFR994SB	Smoked Bronze	Black NEW

Code	Model
GSK194MM	47mm Galvanised Steel Box for Small Combination Multimedia Plate



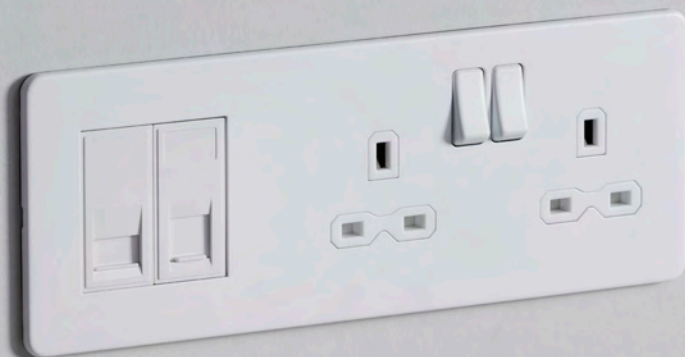

RIGHT HAND 13A 2G SOCKET AND 2G MODULAR COMBINATION

Code	Finish	Insert
SFR192RAT	Anthracite	Black NEW
SFR192RBC	Brushed Chrome	Black NEW
SFR192RBCG	Brushed Chrome	Grey NEW
SFR192RBCW	Brushed Chrome	White NEW
SFR192RMW	Matt White	White NEW
SFR192RMBB	Matt Black	Black NEW

Code	Finish	Insert
SFR192RPC	Polished Chrome	Black NEW
SFR192RPCG	Polished Chrome	Grey NEW
SFR192PCW	Polished Chrome	White NEW
SFR192RSB	Smoked Bronze	Black NEW

Code	Model
GSK335D	35mm 1G + 2G Galvanised Steel Box



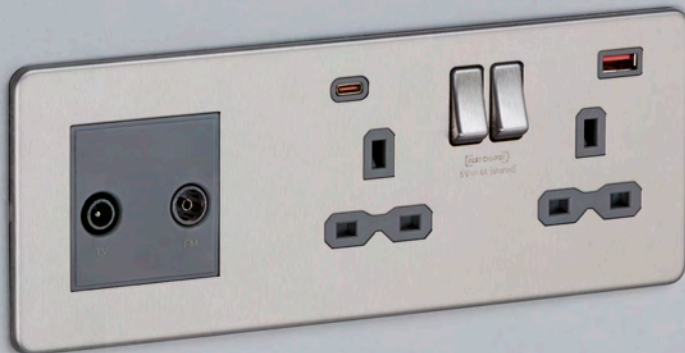

FASTCHARGE



RIGHT HAND 13A 2G SOCKET AND 2G MODULAR COMBINATION WITH USB FASTCHARGE A+C

- FASTCHARGE USB-C port compatible with QC2.0/QC3.0 and USB-PD
- FASTCHARGE USB-A port compatible with QC2.0/QC3.0
- Capable of delivering 0-50% charge in under 30 mins with compatible phones
- 80% faster than a standard 5V DC 2A charger
- Compatible with Android based devices supporting QC2.0/QC3.0 and USB-PD (via USB-C port only)
- Compatible with Apple devices supporting USB-PD (iPhone 8 and above, require certified Lightning to USB-C charge/sync cable) to USB-C charge/sync cable)"



Code	Finish	Insert
SFR992RAT	Anthracite	Black NEW
SFR992RBC	Brushed Chrome	Black NEW
SFR992RBCG	Brushed Chrome	Grey NEW
SFR992RBCW	Brushed Chrome	White NEW
SFR992RMW	Matt White	White NEW
SFR992RMBB	Matt Black	Black NEW

Code	Finish	Insert
SFR992RPC	Polished Chrome	Black NEW
SFR992RPCG	Polished Chrome	Grey NEW
SFR992RPCW	Polished Chrome	White NEW
SFR992RSB	Smoked Bronze	Black NEW

Code	Model
GSK335D	35mm 1G + 2G Galvanised Steel Box





LEFT HAND 13A 2G SOCKET AND 2G MODULAR COMBINATION

Code	Finish	Insert
SFR192LAT	Anthracite	Black NEW
SFR192LBC	Brushed Chrome	Black NEW
SFR192LBCG	Brushed Chrome	Grey NEW
SFR192LBCW	Brushed Chrome	White NEW
SFR192LMW	Matt White	White NEW
SFR192LMBB	Matt Black	Black NEW

Code	Finish	Insert
SFR192LPC	Polished Chrome	Black NEW
SFR192LPCG	Polished Chrome	Grey NEW
SFR192LPCW	Polished Chrome	White NEW
SFR192LSB	Smoked Bronze	Black NEW

Code	Model
GSK335D	35mm 1G + 2G Galvanised Steel Box



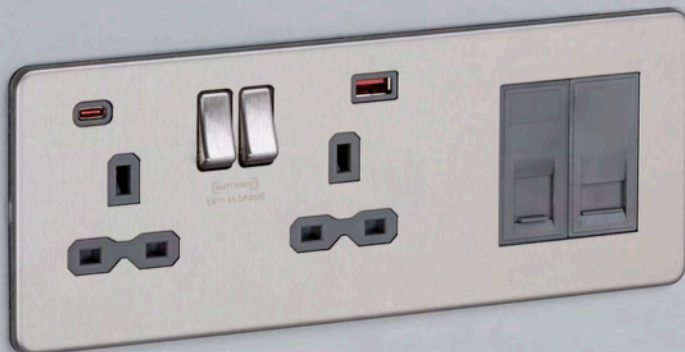

MODULAR INSERTS
AVAILABLE ON PAGE 155

FASTCHARGE



LEFT HAND 13A 2G SOCKET AND 2G MODULAR COMBINATION WITH USB FASTCHARGE A+C

- FASTCHARGE USB-C port compatible with QC2.0/QC3.0 and USB-PD
- FASTCHARGE USB-A port compatible with QC2.0/QC3.0
- Capable of delivering 0-50% charge in under 30 mins with compatible phones
- 80% faster than a standard 5V DC 2A charger
- Compatible with Android based devices supporting QC2.0/QC3.0 and USB-PD (via USB-C port only)
- Compatible with Apple devices supporting USB-PD (iPhone 8 and above, require certified Lightning to USB-C charge/sync cable)



Code	Finish	Insert
SFR992LAT	Anthracite	Black NEW
SFR992LBC	Brushed Chrome	Black NEW
SFR992LBCG	Brushed Chrome	Grey NEW
SFR992LBCW	Brushed Chrome	White NEW
SFR992LMW	Matt White	White NEW
SFR992LMBB	Matt Black	Black NEW

Code	Finish	Insert
SFR992LPC	Polished Chrome	Black NEW
SFR992LPCG	Polished Chrome	Grey NEW
SFR992LPCW	Polished Chrome	White NEW
SFR992LSB	Smoked Bronze	Black NEW

Code	Model
GSK335D	35mm 1G + 2G Galvanised Steel Box





GRID MOUNTING FRAMES



Code	Size
GDS001F	1-2G
GDS002F	3-4G
GDS003F	6-8G
GDS004F	9-12G



GRID FACEPLATES

To indicate preferred finish, replace xx on code with BC (brushed chrome), PC (polished chrome), MW (matt white), MB (matt black), AT (anthracite), SB (smoked bronze) or BN (black nickel)

Code	Size
GDSF001xx	1G
GDSF002xx	2G
GDSF003xx	3G
GDSF004xx	4G
GDSF006xx	6G
GDSF008xx	8G
GDSF009xx	9G
GDSF012xx	12G

STEEL BACK BOXES

- 35mm deep
- Fixed and adjustable mounting lugs
- Galvanized steel construction 1mm thickness (+/- 1%)
- Earth terminals
- Mix of 20mm and 25mm knockout positions

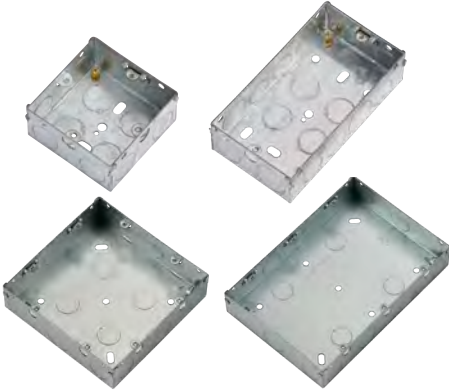

Code	Size
GSK35	1-2G
GSK235	3-4G
GDSG68G	6-8G
GDSG912G	9-12G

20AX GRID SWITCH MODULES



Code	Model
GDM001xx	2-Way SP
GDM002xx	DP
GDM003xx	DP + LED Indicator
GDM004xx	2-Way SP (Centre-Off)
GDM005xx	Intermediate
GDM006xx	2-Way SP Retractive (Marked "PRESS")

To indicate preferred finish, replace xx on code with BC (brushed chrome), PC (polished chrome), MW (matt white), MB (matt black), AT (anthracite), SB (smoked bronze) or BN (black nickel)



10A GRID FAN ISOLATOR MODULES

- Triple pole
- Requires single grid position only



Code	Model
GDM020xx	Fan Isolator Switch Module
GDM021xx	Fan Isolator Key Switch Module (Supplied with Test Key)

20AX GRID KEY SWITCH MODULES

- Supplied with test key



Code	Model
GDM007xx	2-Way SP (Marked "EMG LTG TEST")
GDM008xx	DP (Marked "EMG LTG TEST")
GDM009xx	2-Way SP
GDM010xx	DP
GDKEY	Spare Key

GRID TRAILING-EDGE DIMMER MODULES

- 10-200W incandescent | 10-100W LED



Code	Model
GDM014xx	1-Way Trailing-Edge Dimmer (Press)
GDM200xx	2-Way Trailing-Edge Dimmer (Rotary)



To indicate preferred finish, replace xx on code with BC (brushed chrome), PC (polished chrome), MW (matt white), MB (matt black), AT (anthracite), SB (smoked bronze) or BN (black nickel)

GRID DUMMY DIMMER MODULE

- Push on/off function only
- Ideal for situations where you require one position to look like a dimmer but act like a switch



Code	Model
GDM022xx	6A 2-Way

MISCELLANEOUS GRID MODULES



Code	Model
GDM011xx	Fuse Holder (13A)
GDM012xx	Flex Outlet (Max. 10mm)
GDM013xx	Blank
GDM017	Indicator - Green
GDM018	Indicator - Red
GDM019	Indicator - Orange

GRID DUAL USB CHARGER MODULE

- Requires two grid positions



Code	Model
GDM016xx	Dual USB Charger Module

GRID ROCKER COVERS

- Easy to install
- Replace an existing rocker with an engraved version indicating the appliance it refers to



Code	Model
GDB01Lxx	Boiler
GDB00STxx	Fan Boost NEW
GDCOFFxx	Coffee Machine NEW
GDCOOKxx	Cooker Hood
GDDISHxx	Dishwasher
GDFANxx	Fan
GDFREEZERxx	Freezer NEW
GDFRIDGExx	Fridge NEW
GDFRIDxx	Fridge Freezer
GDHOBxx	Hob
GDMICROxx	Microwave
GDOVENxx	Oven
GDDRYxx	Tumble Dryer
GDWARMxx	Warming Drawer NEW
GDWASHxx	Washing Machine
GDWASTExx	Waste Disposal NEW
GDWINExx	Wine Cooler NEW

SINGLE GRID POSITION FAN ISOLATOR SWITCH

Exclusive to **Knightsbridge**

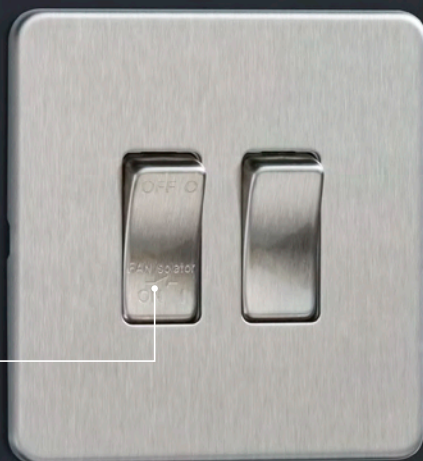

CONTROL
EXTRACTOR
FANS THROUGH
A SINGLE WALL
SWITCH

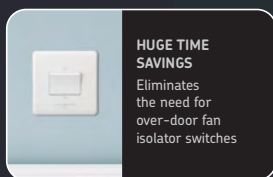

**HUGE TIME
SAVINGS**

Eliminates
the need for
over-door fan
isolator switches



**OPTIONS FIT FOR
DOMESTIC OR
COMMERCIAL USE**

Switch and key switch
modules available in a
variety of finishes



TECHNICAL DETAILS

- Product code:
GDM020XX (switch)
GDM021XX (key switch)
- 10A rated
- Triple pole
- Engraved text
- Quick install: easy clip-in system
- For fans requiring a fuse,
use a GDM011XX fuse holder
alongside the fan isolator
switch options
- Uses just a single grid position



SPECIALIST SOCKETS

The specialist range offers convenient under cabinet, desktop and worktop power solutions. Ideal for kitchens, and commercial and home offices

13A Dual Fitting Sockets	136
Vertical Corner Mount Sockets	137
Pop-up Sockets	138
13A Surface Mount Sockets	139
Pop-up Wireless and Dual USB Charger / Pop-up Dual USB Charger	140
Desk Mount USB Charger / 13A Recess Mount Socket	141



13A DUAL FITTING SOCKETS

- Ideal for kitchens, bedrooms, utility rooms, and hotel rooms
- Matching metal rocker switches
- Also suitable for mounting on counter tops against walls
- Stainless steel finish



SKR009A



SKR008



SKR002A



SKR0014

Code	Model	Height	Width	Projection	Insert
SKR008	2G DP	77mm	212mm	77mm	Grey
SKR009A	2G + Dual USB Charger	77mm	212mm	77mm	Grey
SKR0014	1G + Dual USB Charger + 3W RMS Bluetooth Speaker	79.5mm	212mm	79.5mm	Grey
SKR002A	2G + Dual USB Charger	93mm	211mm	93mm	Black

13A VERTICAL CORNER MOUNT SOCKETS

- The perfect solution for unused corners on kitchen counter tops, in bedrooms, and hotel rooms



Code	Model	Height	Width	Projection	Insert
SKR001A	2G with Removable Phone Holder + Dual USB Charger	236mm	110mm	67mm	Black
SKR0013	1G with Built-In 3W RMS Bluetooth Speaker + Dual USB Charger	236mm	112mm	74mm	Grey





FAST CHARGE



- These devices have a secure clip that locks the unit upright when in use
- Unit can be closed with items plugged in via the innovative cable management cap and inverted socket positions
- IP54 rated when unit is closed and not in use
- 13A Fused
- 230V
- Back-lit ON/OFF rocker
- Fitted with 2m cable and BS plug top
- Cut-out: 90-92mm (allowing a minimum 25mm clearance around the cut hole)
- Mounting board thickness: 10-50mm

IP54 3G POP-UP SOCKET WITH DUAL FASTCHARGE USB (A+C)

Code	Model	
SK9909BC	Brushed Chrome	NEW
SK9909PC	Polished Chrome	NEW
SK9909BN	Black Nickel	NEW



IP54 POP-UP SOCKETS

Code	Model
SK006	3G
SK005A	2G + Dual USB Charger + Bluetooth Speaker





13A 3G RECESS MOUNT POWER STATION WITH DUAL USB FASTCHARGE (A+C)

- Suitable for mounting in desktops and recess wall mounting
- Perfect for home offices, boardrooms, hotel rooms

Code	Model
SKRECF C	Recess Power Station NEW



FAST CHARGE



13A SURFACE MOUNT SOCKETS

- Surface mounted power solutions - ideal for kitchens, bedrooms, offices, and hotels
- Fitted with approx. 2m cable (open ended)
- Back-lit fused ON/OFF rocker switch
- Requires an 18mm to 20mm circular cut-out
- Mounting surface thickness 14mm to 30mm

Code	Model
SK0011	2G with Dual USB Charger
SK004	2G + Speaker with Dual USB Charger

Built-in Dual Fast Charge USB A+C:

- FASTCHARGE USB-C port compatible with QC2.0/QC3.0 and USB-PD
- FASTCHARGE USB-A port compatible with QC2.0/QC3.0
- Capable of delivering 0-50% charge in under 30 minutes with compatible phones
- 80% faster than a standard 5V DC 2A charger
- Compatible with Android based devices supporting QC2.0/QC3.0 and USB-PD (via USB-C port only)
- Compatible with Apple devices supporting USB-PD (iPhone 8 and above, require certified Lightning to USB-C charge/sync cable)





POP-UP DUAL USB CHARGER

- Compact pop-up USB charging solution
- Recess mounts into desks and work surfaces, includes plug-in power supply
- Ideal for workstations, office / home office, and installation into suitable furniture to create a bespoke charging point
- Pop-up action - push to pop up and push to close
- Requires a 44mm circular cut-out
- Minimum mounting surface thickness of 10mm

Code	Model
SK0010	Pop-Up Dual USB Charger



FAST CHARGE

POP-UP WIRELESS DUAL USB CHARGER

- Conveniently charge your compatible phone wirelessly by simply placing on the top pad, or pop up the dual USB socket and fast charge your device via the Type-C USB port
- Wireless charging - effective charging distance: 2-5mm (compatible with Qi wireless charging)
Charging rate DC 5V / 1A
- 1 x Type-A (DC 5V max. 2A)
- 1 x Type-C (DC 5V to 12V max. 3.1A compatible with QC3.0 and PD fast charge)
- Total output: max. 4A when being shared
- Includes plug-in power supply



Code	Model
SK0015	Wireless Desktop Charger with Pop-Up Dual USB Charger





DESK MOUNT USB CHARGER

- 2 x adapters included for existing desk cut-outs
- Dual USB 5V DC 4A (shared)
- Type-A and Type-C USB
- Cable management facility
- Includes plug-in power supply
- 60mm or 80mm cut-out required

Code	Model
SK0012	Desk Mount USB Charger



13A RECESS MOUNT SWITCHED SOCKET

- Provides a protected recess mounted switched socket with USB charging
- Stainless steel lid (not spring loaded)
- Fitted with approx. 2m cable and BS plug top
- Requires a 112mm circular cut-out
- Mounting surface thickness 14mm to 50mm

Code	Model
SKR003A	Recess Mount Socket with Dual USB Charger



IDEAL FOR HOME OFFICES

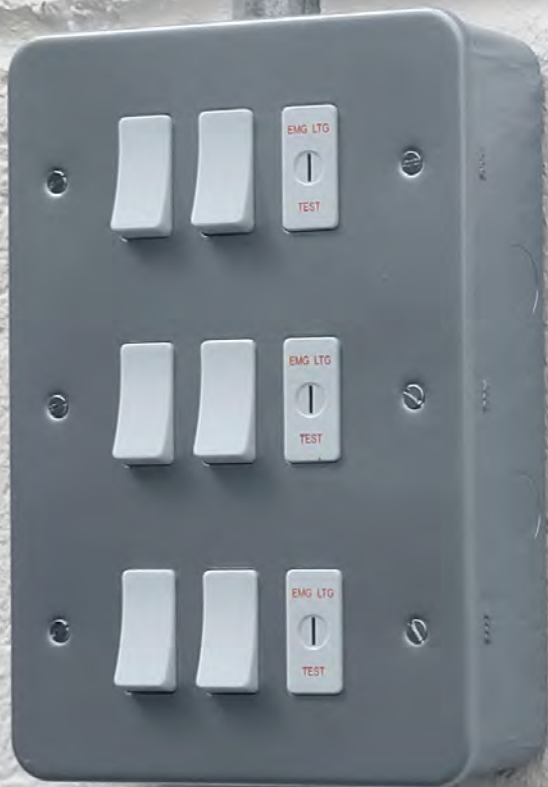

METAL CLAD

Heavy duty switches and sockets finished in a durable powder-coated metal clad finish. Ideal for industrial environments

13A Sockets / Sockets with USB / Fan Isolator Switch / 10AX Switches / Fused Spur Units / 20A Switches	146
45A Cooker Switches and Sockets / Media Outlets / Blanking Plates / Modular Frames	147
Grid Wiring Accessories	148 - 150



DOUBLE POLE SWITCHES

On selected products, for additional safety

COLOUR MATCHING BACK BOX

EASY CABLING

Multiple cable access points



DURABLE

Powder-coated surface



HIGH INTEGRITY EARTHING

Twin earthing terminals (on double switched sockets), for compliance with BS7671: 2018 regulation 543-7

15 YEAR WARRANTY*

*2 years on electronic products

DIMENSIONS*

Single plate: 82mm x 82mm
Double plate: 82mm x 142mm
Projection: 45mm

*Unless otherwise stated



Only high-quality imported US ICs and USB Controllers are used in this range, ensuring trouble-free charging and longevity for hospitality areas

Type A RCD for AC residual current and pulsating DC up to 6 mA. Suitable for equipment with electronic components like IT equipment. Passive (latching) type, which will automatically reset after a power outage, without the need for manual resetting.

NEW RCD ADDITIONS



M9RCD

13A 2G DP RCD SWITCHED SOCKET

- Tripping current ($I_{\Delta n}$): 30mA
- Trip time @ $I_{\Delta n}$: 40ms
- Outboard rockers
- Switch type: Double Pole
- Dual earth terminals
- Captive screw terminals



M6RCD

RCD UNSWITCHED FUSE

- Tripping current ($I_{\Delta n}$): 30mA
- Trip time @ $I_{\Delta n}$: 40ms



10AX SWITCHES

Code	Size	Model
M1200	1G	Intermediate
M2000	1G	2-Way
M3000	2G	2-Way
M4000	3G	2-Way

13A SOCKETS

Code	Size	Model
MR7000	1G	DP Switched Socket
MR7000U	1G	Unswitched Socket
MR9000	2G	DP Switched Socket + Twin Earth
MR9000U	2G	Unswitched Socket + Twin Earth
M9RCD	2G	DP RCD Switched Socket - 30mA (Type-A) NEW Projection 50mm



13A SOCKETS WITH USB

Code	Size	Model
MR9124	1G	Switched Socket with Dual USB Charger
MR9224	2G	Switched Socket with Dual USB Charger + Twin Earth



GRID FAN ISOLATOR
MODULES PAGE 149

10AX FAN ISOLATOR SWITCH

Code	Model
M1100	Triple Pole

FUSED SPUR UNITS

- Double pole switches where applicable

Code	Model
M6000	Unswitched
M6000N	Unswitched + Neon
M6300	Switched
M6300N	Switched + Neon
M6300F	Switched + Flex Outlet (Front)
M6RCD	RCD Unswitched - 30mA (Type-A) NEW Projection 50mm



20A SWITCHES

- Double pole switches

Code	Model
M8341	Switched
M8341N	Switched + Neon



45A COOKER SWITCHES

- Double pole switches

Code	Size	Model
M8331N	Single	Switched + Neon
M8332N	Double	Switched + Neon

BLANKING PLATES

- Backbox not included

Code	Size
M8500	1G
M8600	2G



45A COOKER SWITCH AND SOCKET

- Double pole switches
- 13A switched socket

Code	Model
MR8333N	Switched + Neons

MODULAR FRAMES

- Backbox not included

Code	Size
M1G	1 Module
M2G	1-2 Modules
M4G	3-4 Modules



MEDIA OUTLETS

Code	Model
M7300	Telephone Socket - Master
M7400	Telephone Socket - Extension
MRJ45	Network Outlet - RJ45



MODULAR SOLUTIONS AVAILABLE
ON PAGE 155



GRID FACEPLATES

- Requires grid mounting frame (sold separately)
- For use with Knightsbridge grid accessories only

Code	Size
GDFP001M	1G
GDFP002M	2G
GDFP003M	3G
GDFP004M	4G

Code	Size
GDFP006M	6G
GDFP008M	8G
GDFP009M	9G
GDFP0012M	12G



GRID MOUNTING FRAMES

Code	Size
GDF001F	1-2G
GDF002F	3-4G



DURABLE POWDER-COATED GRID BACK BOXES

- 44mm deep
- Fixed mounting lugs
- With earth terminals
- Mix of 20mm knockout positions

Code	Size	
M8700	1-2G	1 x Earth Terminal
M8900	3-4G	1 x Earth Terminal
GDSG68M	6-8G	2 x Earth Terminals
GDSG912M	9-12G	2 x Earth Terminals



20AX GRID SWITCH MODULES

Code	Model
GDM001U	2-Way SP
GDM002U	DP
GDM003U	DP + LED Indicator
GDM004U	2-Way SP (Centre-Off)
GDM005U	Intermediate
GDM006U	2-Way SP Retractive (Marked "PRESS")



10A GRID FAN ISOLATOR MODULES

- Triple pole
- Requires one grid position only

Code	Model
GDM020U	Grid Fan Isolator Switch Module
GDM021U	Grid Fan Isolator Key Switch Module (Supplied with Test Key)



20AX GRID KEY SWITCH MODULES

Code	Model
GDM007U	2-Way SP (Marked "EMG LTG TEST")
GDM008U	DP (Marked "EMG LTG TEST")
GDM009U	2-Way SP
GDM010U	DP
GDKEY	Spare Key



GRID TRAILING-EDGE DIMMER MODULES

- 10-200W incandescent | 10-100W LED

Code	Model
GDM014U	1-Way Trailing-Edge Grid Press Dimmer
GDM200U	2-Way Trailing-Edge Grid Rotary Dimmer

GRID DUAL USB CHARGER MODULE

- Requires two grid positions

Code	Model
GDM016U	Dual USB Charger Module



GRID DUMMY DIMMER MODULE

- Push on/off function only
- Ideal for situations where you require one position to look like a dimmer but act like a switch

Code	Model
GDM022U	6A 2-Way



MISCELLANEOUS GRID MODULES

Code	Model
GDM011U	Fuse Holder (13A)
GDM012U	Flex Outlet (Max. 10mm)
GDM013U	Blank
GDM017	Indicator - Green
GDM018	Indicator - Red
GDM019	Indicator - Orange



GRID ROCKER COVERS

- Easy to install
- Replace an existing rocker with an laser or pad printed version indicating the appliance it refers to

Code	Model
GDBOILU	Boiler
GDCOFFU	Coffee Machine NEW
GDCOOKU	Cooker Hood
GDDISHU	Dishwasher
GDFANU	Fan
GDFREEZERU	Freezer NEW
GDFRIDGEU	Fridge NEW
GDFRIDU	Fridge Freezer

Code	Model
GDH0BU	Hob
GDMICROU	Microwave
GDOVENU	Oven
GDDRYU	Tumble Dryer
GDWARMU	Warming Drawer NEW
GDWASHU	Washing Machine
GDWASTEU	Waste Disposal NEW
GDWINEU	Wine Cooler NEW
GDBOOSTU	Fan Boost



Subscribe to our YouTube channel for product demos, technical FAQs, and more!

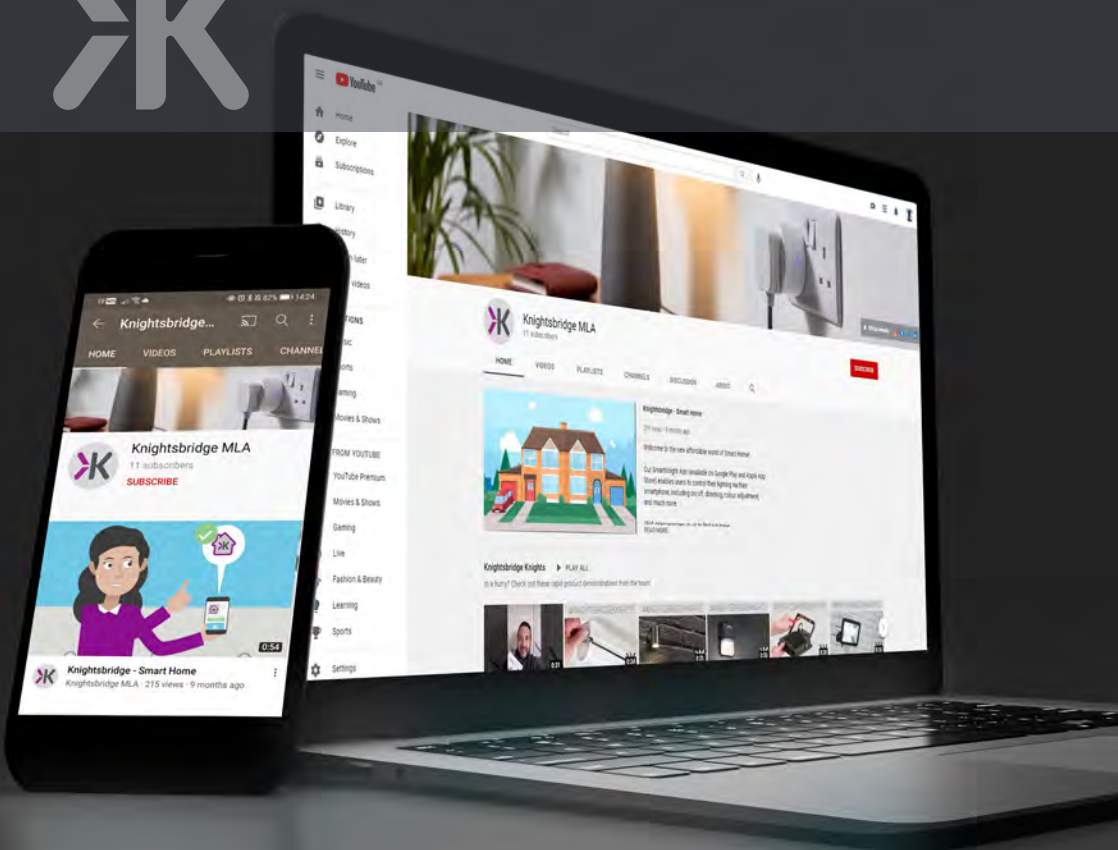



DATACOMMS

A comprehensive range of datacomms accessories. The expansive selection of black, white and grey inserts can be used alongside the entire offering of Knightsbridge switches and sockets

Telecom Modules	155
TV Modules	156
HDMI Modules / Brush Modules / HDMI Cables	157
USB Modules / USB Cables	158
13A Socket Modules / Round Pin Socket Modules / Blank Modules / Touchless Switch Modules	159
Modular PIR Sensors	160
Network Cables / Network Patch / Panels / Network Accessories	161



MODULAR SOLUTIONS

Knightsbridge



METAL DECORATIVE MULTIMEDIA PLATES PAGES 122 - 129

NEW



TELECOM MODULES

- 25mm x 50mm modules
- IDC termination

Code	Model	Finish
NETBTMWH	Master	White
NETBTMGY	Master	Grey
NETBTMBK	Master	Black
NETBTSWH	Extension	White
NETBTSGY	Extension	Grey
NETBTSBK	Extension	Black
NETRJ11WH	RJ11	White
NETRJ11GY	RJ11	Grey

Code	Model	Finish
NETRJ11BK	RJ11	Black
NETCAT5WH	UTP CAT5e RJ45	White
NETCAT5GY	UTP CAT5e RJ45	Grey
NETCAT5BK	UTP CAT5e RJ45	Black
NETCAT6WH	UTP CAT6 RJ45	White
NETCAT6GY	UTP CAT6 RJ45	Grey
NETCAT6BK	UTP CAT6 RJ45	Black



COAX TV MODULES

- Clamp-on PCB type connection
- 25mm x 50mm modules
- Coax socket

Code	Finish
NETTVWH	White
NETTVGY	Grey
NETTVBK	Black

SAT TV MODULES

- 25mm x 50mm modules
- F-Type coupler connection

Code	Finish
NETSATWH	White
NETSATGY	Grey
NETSATBK	Black



SCREENED COAX TV MODULES

- 25mm x 50mm modules
- Coax socket

Code	Finish
NETTVSWH	White
NETTVSGY	Grey
NETTVSBK	Black



SCREENED SAT TV MODULES

- 25mm x 50mm modules
- F-type connection

Code	Finish
NETSATSWH	White
NETSATSGY	Grey
NETSATSBK	Black



SCREENED DIPLEX TV / FM DAB MODULES

- 50mm x 50mm modules
- Coax plug / coax socket

Code	Finish
NETDITVWH	White
NETDITVGY	Grey
NETDITVBK	Black



SCREENED DIPLEX TV / SAT TV MODULES

- 50mm x 50mm modules
- Coax plug / F-type connection

Code	Finish
NETDISATWH	White
NETDISATGY	Grey
NETDISATBK	Black



SCREENED TRIPLEX TV / FM DAB / SAT TV MODULES

- 50mm x 50mm modules
- Coax plug / coax socket / F-type connection

Code	Finish
NETTRIWH	White
NETTRIGY	Grey
NETTRIBK	Black



SCREENED QUADPLEX TV / FM DAB / SAT1 / SAT2 MODULES

- 50mm x 50mm modules
- Coax plug / coax socket / 2 x F-type connections

Code	Finish
NETQDWH	White
NETQDGY	Grey
NETQDBK	Black



HDMI MODULES

- 25mm x 50mm modules
- HDMI socket on 100mm cable for easy cable management
- HDMI socket-to-socket connection

Code	Finish
NETHDMIWH	White
NETHDMIGY	Grey
NETHDMIBK	Black



BRUSH MODULES

- Facilitates a tidy cable entry/exit from wall
- Use in conjunction with any of our modular faceplates to create a brush outlet faceplate

Code	Size	Finish
NETBR1GW	25mm x 50mm	White
NETBR1GGY	25mm x 50mm	Grey
NETBR1G	25mm x 50mm	Black
NETBR2GW	50mm x 50mm	White
NETBR2GGY	50mm x 50mm	Grey
NETBR2G	50mm x 50mm	Black
NETBR4GW	100mm x 50mm	White
NETBR4GGY	100mm x 50mm	Grey
NETBR4G	100mm x 50mm	Black

NB: Not intended for use alongside power sockets / modules in same channel due to potential hazardous voltage that may be present and easily reached



ASSEMBLED BRUSH MODULE FACEPLATES

Code	Size	Finish
NETBRUSH2G	Single Plate Assembled	White
NETBRUSH4G	Twin Plate Assembled	White



KNIGHTSBRIDGE HDMI CABLES

- Black and grey cable with nylon braiding and over-moulded strain relief for durability
- Gold plated connectors for enhanced connectivity



4K HIGH SPEED HDMI CABLES

- HDMI 2.0 (certified) HDMI-A to HDMI-A
- Supports 1080p / 4K / 4K 60Hz / 3D / HDR
- Supports ARC and 18Gbps

Code	Model	
AVHD4K2	2m	NEW
AVHD4K3	3m	NEW
AVHD4K5	5m	NEW
AVHD4K10	10m	NEW



8K ULTRA HIGH SPEED HDMI CABLE

- HDMI 2.1 (certified) HDMI-A to HDMI-A
- Supports 1080p / 4K / 4k 120Hz / 3D / HDR / 8K 60Hz
- Supports ARC and 48Gbps

Code	Model	
AVUHD8K2	2m	NEW



NEW

USB-C CABLES



DUAL USB CHARGER MODULES (TYPE-A/TYPER-C)

- 25mm x 50mm modules
- 1 x Type-A and 1 x Type-C
- 5V DC 3.1A (shared)



Code	Finish
NETUSBCWH	White
NETUSBCGY	Grey
NETUSBCBK	Black



60W USB CABLES

- 1.5m black cable with over-moulded strain relief for durability
- Supports up to 20V 3A (60W)
- Supports 5Gbps transfer rates
- USB certified

Code	Finish	
AVCC15	USB-C to USB-C	NEW
AVAC15	USB-A to USB-C	NEW



100W USB-PD CABLE

- 1.5m black and grey cable with nylon braiding and over moulded strain relief for durability
- Supports up to 20V 5A (100W)
- Supports 10Gbps transfer rates between supporting devices (e.g. Thunderbolt 3, 5K and UHD displays)
- Supports 4K HD
- E-Marker IC
- USB certified

Code	Finish	
AVPDC15	USB-C to USB-C	NEW



5A ROUND PIN SOCKET MODULES

- Unswitched
- 50mm x 50mm modules

Code	Finish
NET5AWH	White
NET5AGY	Grey
NET5ABK	Black

QUARTER BLANK MODULES

- 12.5mm x 50mm modules
- Supplied in packs of 10

Code	Finish
NETQWH	White
NETQGY	Grey
NETQBK	Black



13A SOCKET MODULES

- Unswitched
- 50mm x 50mm modules

Code	Finish
NET13WH	White
NET13GY	Grey
NET13BK	Black



HALF BLANK MODULES

- 25mm x 50mm modules
- Supplied in packs of 10

Code	Finish
NETHWH	White
NETHGY	Grey
NETHBK	Black



TOUCHLESS SWITCH MODULES

- Gesture controlled (on/off)
- Sensor detection range: up to 80mm
- Max. load: 500W resistive / 200W inductive / 100W LED
- 50 x 50mm modules
- Minimum mounting box depth: 47mm
- Requires neutral

Code	Finish	
NETTS1BK	Black	NEW
NETTS1GY	Grey	NEW
NETTS1WH	White	NEW



HELPS REDUCE THE
SPREAD OF GERMS
AND BACTERIA



Shown with SF2GBC, SF2GBC available separately



NETPIRWH



NETPIRGY



NETPIRBK



NETPIRSWH



NETPIRSGY



NETPIRSBK

MODULAR PIR SENSORS

- Voltage: 220-240V 50Hz
- Operation: passive infrared
- Time pre-set: 3mins.
- NETPIRSxx with override allows Auto or ON control

- Suitable for 47mm back box
- Lux sensitive and time operation fixed
- Live and Neutral wiring required

Field of detection: 120°

Finishes: To indicate desired finish, please replace 'xx' with suffix WH (white), GY (grey), or BK (black) – e.g. NETPIRBK

230V
50Hz

IP20

Code	Range*	Model	Max. Load	
NETPIRxx	5m	PIR Sensor Module 50x50mm	200W Incandescent and 100W LED	NEW
NETPIRSxx	5m	PIR Sensor Module with Override Switch 50x50mm	200W Incandescent and 100W LED	NEW

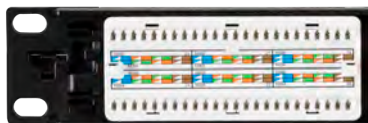

NETWORK PATCH PANELS

- 19" 1U 24-port
- Universal / 110 IDC termination
- Port identification
- Dual 568A/B

Code	Model	
NETC524	UTP CAT5e	NEW
NETC624	UTP CAT6	NEW



NETWORK CABLES

- CCA 24AWG
- RJ45 to RJ45 snagless boots

Code	Model	Finish
NETC51M	1m - UTP CAT5e	Grey
NETC53M	3m - UTP CAT5e	Grey
NETC55M	5m - UTP CAT5e	Grey
NETC510M	10m - UTP CAT5e	Grey

Code	Model	Finish
NETC61M	1m - UTP CAT6	Black
NETC63M	3m - UTP CAT6	Black
NETC65M	5m - UTP CAT6	Black
NETC610M	10m - UTP CAT6	Black



NETWORK ACCESSORIES

Code	Size	Model
NETC5CP	RJ45 Coupler	UTP CAT5e
NETC6CP	RJ45 Coupler	UTP CAT6
NETJBC5E	Junction Box	UTP CAT5e
NETJBC6	Junction Box	UTP CAT6



GRID WIRING ACCESSORIES

IDEAL FOR THE MOST DEMANDING PROJECTS

Grid wiring accessories offer multiple switching options, control, and additional features such as USB charging.

With solutions available across multiple ranges, our grid offering is versatile and offers a perfect solution for domestic, industrial, and commercial installations.

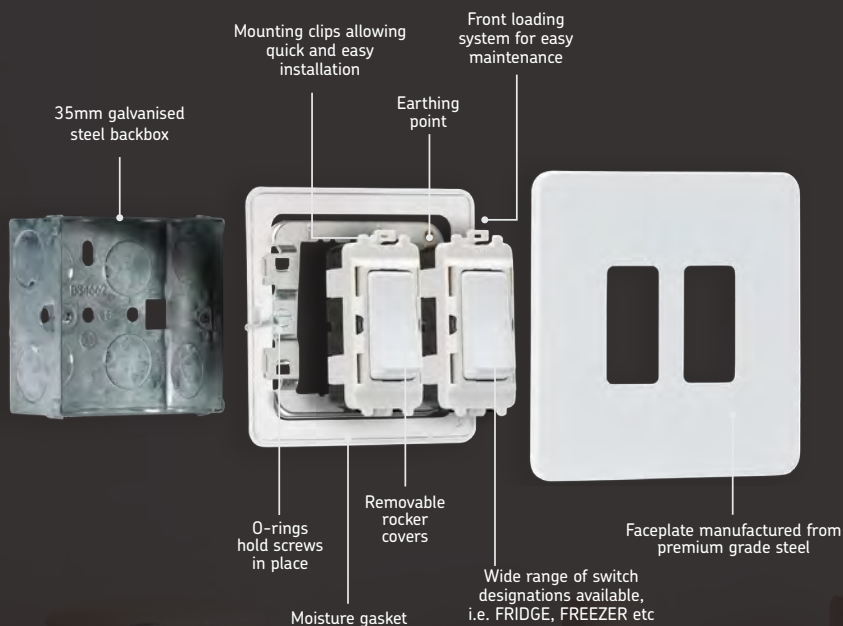

ACCESSORIES



CURVED EDGE

PAGES 26 - 27



ROUNDED EDGE

PAGES 41 - 43



Available in: Brushed Chrome and Polished Chrome



SQUARE EDGE

PAGES 58 - 60



Available in: Brushed Chrome



FLAT PLATE

PAGES 85 - 87



Available in: Brushed Chrome and Polished Chrome



SCREWLESS

PAGES 130 - 132



Available in: Brushed Chrome, Polished Chrome, Matt White, Matt Black, Anthracite, Smoked Bronze, and Black Nickel



METAL CLAD

PAGES 148 - 150



Manufactured to the latest British Safety Standards

Example shown here is for Screwless grid accessories, construction on other ranges may vary



WEATHERPROOF

Outdoor wiring accessories, providing everything you need to safely deliver power to domestic and commercial outdoor spaces

13A Outdoor Sockets / 13A Remote Controlled Outdoor Socket / 13A Smart Outdoor Sockets	166 - 167
13A RCD Switched Socket / Fused Spur Units / Outdoor Socket Kit	168
20AX Outdoor Light Switches / Outdoor Photocell Sensor	169
Outdoor Control Boxes / RF Remote Controlled	170
Weatherproof Boxes	172
Outdoor Enclosures	173
Weatherproof Connectors / Cable Gland	174



Multiple 20mm
cable access points

Power indicator

Rugged, impact resistant
polycarbonate construction

Transparent casing.
Lid holds open when
required for ease of use

Padlock ready,
securable lid

IP66 Protected from solid objects
including dust and powerful jets of
water from all directions

IP66

IK06 Protected against 1 joule impact.
Equivalent to the impact of a 0.25 kg mass
being dropped from 400mm above item

IK06



IP66 **IK06**

13A 2G REMOTE CONTROLLED OUTDOOR SOCKET

Remote control outdoor socket solution, enabling you to control your socket from a convenient key fob style remote control

- Control either socket from your key remote fob
- Ideal for controlling outdoor devices like water features or pond lighting
- Remote fob remote requires 2 x 3V CR2016 Lithium batteries (included)
- Range of up to 30m

13A OUTDOOR SOCKETS

- Rugged, impact resistant polycarbonate construction
- Double pole switches
- Large-sized locking mechanism for ease of use
- Transparent casing allowing on/off power indicators to be seen at a distance, and offers extra clearance for the more robust fully moulded plug tops
- Lockable lid (padlock not included)
- Multiple 20mm cable access points (sides and rear)

Code	Size	Model
OP7N	1G	DP + Indicator (Twin Earth)
OP9N	2G	DP + Indicator (Twin Earth)

Code	Model	
OP9R	IP66 2G Remote Controlled Switched Socket	NEW
OPKEYFOB	Spare Remote	NEW

13A 2G SMART OUTDOOR SOCKET

- Controls up to 2 outdoor appliances
- Wi-Fi Connectivity IEEE 802.11 b/g/n (2.4GHz only)
- Manually override by using the switch on the socket
- Rugged outdoor enclosure
- Range: 20m-40m (depending on Wi-Fi signal coverage)

Code	Model
OP9KW	IP66 2G Smart Outdoor Switched Socket

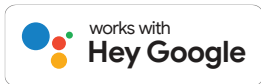

Amazon, Alexa and all related logos are trademarks of Amazon.com, Inc. or its affiliates.

Google is a trademark of Google LLC.

See Page 206 for more info on Smart



13A 2G DP RCD SWITCHED SOCKET

Type A RCD for AC residual current and pulsating DC up to 6 mA. Suitable for equipment with electronic components like IT equipment

Passive (latching) type; will automatically reset after a power outage, without the need for manual resetting.

- Tripping current (I Δ n): 30mA
- Trip time @ I Δ n: 40ms
- Outboard rockers
- Double pole switches
- Twin Earth terminals

IP66

IK06

Code	Model	
OP9RCD	IP66 13A 2G DP RCD Switched Socket	NEW



FUSED SPUR UNITS

Code	Model
OP63N	Switched + Indicator
OP6N	Unswitched + Indicator



OUTDOOR SOCKET KIT

- 2G Outdoor socket
- RCD Plug
- 3m Rubber outdoor cable

Code	Size	Model
OPRCDKIT	2G	Outdoor Socket Kit + RCD Plug

Kit supplied unassembled

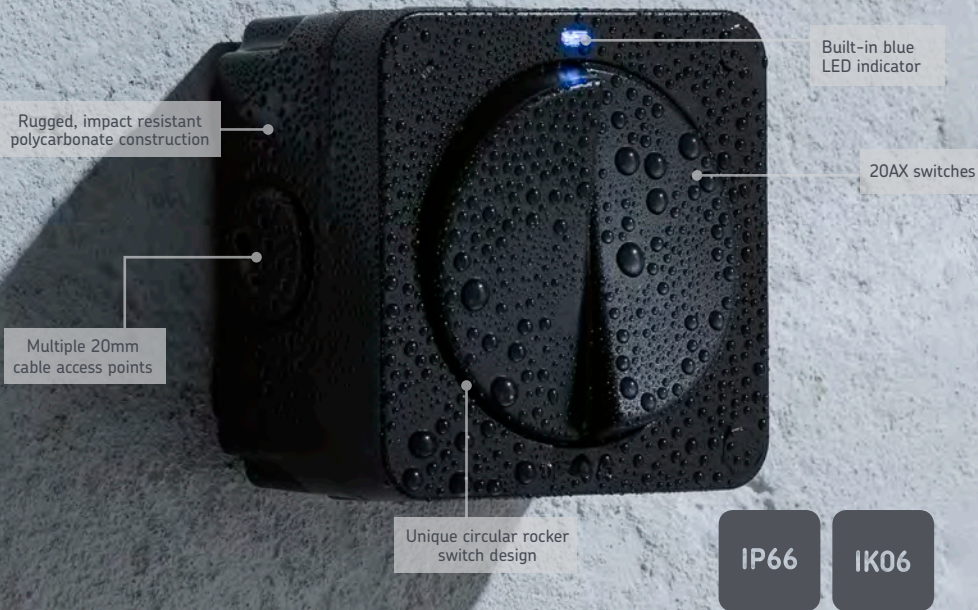

20AX OUTDOOR LIGHT SWITCHES

Code	Model
OP2	1G 2-Way with Indicator
OP3	2G 2-Way with Indicator
OP21	1G Retractive with Indicator



OUTDOOR PHOTOCELL SENSOR

- Dusk-to-dawn photocell timer. Ideal for controlling outdoor lighting during the evenings for security and convenience
- Suitable for garden or communal lighting solutions as well as shop window display lighting and advertising systems
- Wall mountable - easy installation

230V
50Hz

IP55

Code	Function	Max. Load	Colour
OS006	Ambient Light Memory Function - 2/4/6/8hr Durations	1000W Incandescent / 200W LED	White
OS006B	Ambient Light Memory Function - 2/4/6/8hr Durations	1000W Incandescent / 200W LED	Black NEW



IP66

IK06

OUTDOOR CONTROL BOXES

- Manual and RF remote control boxes
- Rugged and impact resistant polycarbonate construction
- Multiple 20mm cable access points
- Range of up to 20m on wireless models (dependent on environment)

MANUAL

Code	Load	Model	Finish
IP3G	13A	3G	Grey
OP3G	13A	3G	Black NEW
IP5G	13A	5G	Grey
OP5G	13A	5G	Black NEW



RF REMOTE CONTROLLED

Code	Load	Model	Finish
IP663G	13A	3G Control Box + Remote	Grey
OP663GBK	13A	3G Control Box + Remote	Black NEW
IP665G	13A	5G Control Box + Remote	Grey

Code	Load	Model	Finish
OP665GBK	13A	5G Control Box + Remote	Black NEW
IPREMOTE		Spare Remote Control*	Grey
OPREMOTE		Spare Remote Control*	Black NEW

*For use with Knightsbridge remote controlled boxes only

KNOW YOUR IP RATING

IPxx

First digit

Indicates the level of protection against access to hazardous parts and the ingress of solid objects

Second digit

Indicates the level of protection against the harmful ingress of water

1

>50mm

Protection against any large surface of the body, such as the back of a hand, but no protection against deliberate contact

2

>12.5mm

Protection against fingers or similar objects

3

>2.5mm

Protection against tools, thick wires, etc

4

>1mm

Protection against most wires, slender screws, large insects etc

5

Dust protected

Protection against dust that may harm equipment

6

Dust tight

No ingress of dust; complete protection against ingress

1

Dripping water

Protection against vertical drops when mounted in an upright position onto a turntable and rotated at 1 RPM

2

Dripping water (tilted)

Protection against water droplets when tilted up to 15° from vertical

3

Spraying water

Protection against water spray up to an angle of 60 degrees

4

Splashing water

Protection against splashing water from any direction

5

Water jets

Protection against low pressure jets of water from any direction

6

Powerful water jets

Protection against high pressure jets of water from any direction

Please note, IPX7 and IPX8 are tested using different methods from IPX6 and below. Products with IPX7 or IPX8 ratings are not necessarily protected from water jets or splashes

7

Immersion up to 1m

Protection from immersion in water under defined conditions of pressure and time

8

Immersion beyond 1m

Protection from immersion in water under defined conditions of pressure and time



IP66

See on page 135



Contents not included

IP55

IK06

WEATHERPROOF BOXES

Ideal for creating bespoke outdoor wiring requirements, for outdoor seasonal lighting, and general outdoor power requirements

- 5 channel gasket allows 1 x power in and 4 x power out, ideal for use with a 4G trailing socket
- Wall mountable via rear mounting plate
- Velcro mounting pad included with velcro tape
- Screwless design, easy to open and close

Code	Height	Width	Projection	Model
JB55	334mm	220mm	116mm	Grey
JB55BK	334mm	220mm	116mm	Black



IDEAL FOR USE WITH...



20042M / 20043M
Extension leads



1GAKW
Smart plug

Quickly create interactive outdoor lighting displays by combining a Knightsbridge extension lead and smart plug(s), within a JB55 weatherproof box



OUTDOOR ENCLOSURES

- Rugged, impact resistant polycarbonate construction
- Multiple 20mm cable access points
- Designed for use up to 230V 50Hz

IP66

IK06

Code	Height	Width	Projection	Model
JB007	86mm	74mm	62mm	Grey
JB008	86mm	125mm	62mm	Grey
JB009	111mm	181mm	100mm	Grey
JB0010	184mm	274mm	135mm	Grey

Code	Height	Width	Projection	Model
JB007BK	86mm	74mm	62mm	Black
JB008BK	86mm	125mm	62mm	Black
JB009BK	111mm	181mm	100mm	Black
JB0010BK	184mm	274mm	135mm	Black



WEATHERPROOF CONNECTORS

- IP68 rated
- 450V 16A
- 3 pole
- For use with H07RNF 3G 0.75mm² to 4.0mm² cable

IP68



Code	Depth	Cable Diameter	Model
JB002	5bar	Min. 5mm / Max. 14mm	Inline Connector
JB003	2bar	Min. 5mm / Max. 14mm	3-Way Connector
JB004	2bar	Min. 5mm / Max. 10mm	3-Way Connector Box
JB0011	2bar	Min. 5mm / Max. 12mm	Plug & Socket Connector

IP66 CABLE GLAND

For use with outdoor switches, sockets, and enclosures

IP66

Code	Size	Qty
JB006	M20 (20mm)	10



Knightsbridge

Committed to a brighter future



At Knightsbridge, we believe in looking after our customers and looking after our planet. This philosophy is important to us and is why we have started to apply it to the way we package and present our products.

We are now working in conjunction with the FSC® moving towards 100% recyclable / 100% recycled packaging solutions. Look out for the FSC® label on our certified packaging.

This is our plan, this is our commitment to a brighter future.

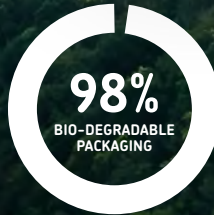

ENVIRONMENTALLY APPROPRIATE forest management ensures that the harvest of timber and non-timber products maintains the forest's biodiversity, productivity, and ecological processes.



SOCIALLY BENEFICIAL forest management helps both local people and society at large to enjoy long term benefits and also provides strong incentives to local people to sustain the forest resources and adhere to long-term management plans.



ECONOMICALLY VIABLE forest management means that forest operations are structured and managed so as to be sufficiently profitable, without generating financial profit at the expense of the forest resource, the ecosystem, or affected communities.



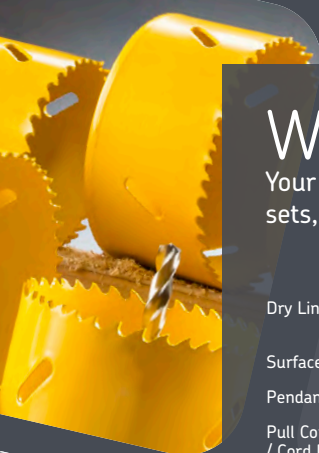

WIRING BASICS

Your everyday electrical essentials, including pendant sets, extension leads, tools, testing kits, and more

Dry Lining Boxes / Back Boxes	178
Surface Boxes / Junction Boxes / Service Connector Blocks	179
Pendant Sets	180 - 181
Pull Cord Switches / Batten Holders / Lamp Holders / Cord Switches / Cord Dimmers	182
Extension Leads / Mains Adaptors	183
Plug Tops / Fuses / Strip Connectors / Screws / Cap Covers	184
Holesaws	185
Testing Kits	186





DRY LINING BOXES

- Large flange to prevent slipping into cavity
- Two adjustable lugs
- Cable entry channels top and bottom (except SN8375)
- Cable knockout on rear
- Minimum 7mm plasterboard thickness required

Code	Model	Qty
SN8370	35mm - 1G	10
SN8381	47mm - 1G	10
SN8380	35mm - 2G	10
SN8382	47mm - 2G	10
SN8375	34mm Round	10
SN8380D	35mm Dual	10
SN8335D	35mm 1G + 2G	5



GRID BACK BOXES

Code	Model	Qty
GDSG68G	35mm 6-8G + Earth Terminals	1
GDSG912G	35mm 9-12G + Earth Terminals	1

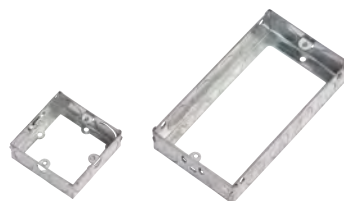

EXTENSION BOXES

Code	Model	Qty
GSE25	25mm Single	10
GSE225	25mm Double	5



GALVANISED STEEL BOXES

- Galvanized steel construction 1mm thickness (+/- 1%)

- One fixed mounting lug and one adjustable mounting lug (except architrave and dual boxes)
- Cable knockouts on all sides (except architrave and 16mm boxes)

Code	Model	Qty
GSK27	27mm Architrave + Earth Terminal	20
GSK16	16mm 1G + Earth Terminal	20
GSK25	25mm 1G + Earth Terminal	10
GSK35	35mm 1G + Earth Terminal	10
GSK47	47mm 1G + Earth Terminal	10
GSK225	25mm 2G + Earth Terminal	5
GSK235	35mm 2G + Earth Terminal	5

Code	Model	Qty
GSK247	47mm 2G + Earth Terminal	5
GSK235D	35mm Dual + Earth Terminal	5
GSK298MM	47mm 4 x 2G + Earth Terminals	1
GSK335	35mm Triple + Earth Terminal	5
GSK335D	35mm 1G + 2G + Earth Terminal	5
GSK194MM	47mm 2 x 2G + Earth Terminals	1 NEW



SURFACE-MOUNT BOXES

- Suitable for use with Knightsbridge Screwless and Flat Plate switches and sockets
- 32mm deep

Code	Size	Finish	
1GSBBK	1G	Black	
1GSBGY	1G	Grey	
1GSBW	1G	White	
1GSBBC	1G	Brushed Chrome Effect	NEW
1GSBPC	1G	Polished Chrome Effect	NEW
2GSBBK	2G	Black	NEW
2GSBGY	2G	Grey	NEW
2GSBW	2G	White	NEW
2GSBBC	2G	Brushed Chrome Effect	NEW
2GSBPC	2G	Polished Chrome Effect	NEW



JUNCTION BOXES

- Heavy-duty construction
- Ideal for mains and low voltage installations

Code	Model	Qty
SN8400	5A - 4 Terminal - White 59mm	20
SN8400B	5A - 4 Terminal - Black 59mm	20
SN8410	20A - 4 Terminal - White 59mm	20
SN8410B	20A - 4 Terminal - Black 59mm	20
SN8420	20A - 4 Terminal - White 79mm	10
SN8420B	20A - 4 Terminal - Black 79mm	10

Code	Model	Qty
SN8430	30A - 3 Terminal - White 89mm	10
SN8430B	30A - 3 Terminal - Black 89mm	10
SN8460	20A - 6 Terminal - White 89mm	10
SN8460B	20A - 6 Terminal - Black 89mm	10
SN8470	60A - 3 Terminal - White	5
SN8470B	60A - 3 Terminal - Brown	5



SERVICE CONNECTOR BLOCKS

- Heavy-duty service connector blocks for use at meter and mains positions
- 100A 240V
- Black phenolic urea construction
- Secure sealable lid
- For max. 35mm² rigid conductor

Code	Model	Qty
SNEB1	SP 1 x 5-Way	10

Code	Model	Qty
SNEB2	DP 2 x 5-Way	10



- 3 plate format
- Metal finish ceiling rose and lampholder
- Braided cord flex
- Contemporary styled lampholder

6" CONTEMPORARY METAL PENDANT SETS

Code	Size	Model	
8270MB	6" T2 E27	Matt Black	
8270MW	6" T2 E27	Matt White	
8270BC	6" T2 E27	Brushed Chrome	
8270PC	6" T2 E27	Polished Chrome	
8270BN	6" T2 E27	Black Nickel	
8270AB	6" T2 E27	Antique Brass	
8270PB	6" T2 E27	Polished Brass	
8270AT	6" T2 E27	Anthracite	NEW
8270SB	6" T2 E27	Smoked Bronze	NEW



1.8M CONTEMPORARY METAL PENDANT SETS

Code	Size	Model	
8270LMB	1.8m T2 E27	Matt Black	NEW
8270LMW	1.8m T2 E27	Matt White	NEW
8270LBC	1.8m T2 E27	Brushed Chrome	NEW
8270LPC	1.8m T2 E27	Polished Chrome	NEW
8270LBN	1.8m T2 E27	Black Nickel	NEW
8270LAB	1.8m T2 E27	Antique Brass	NEW
8270LPB	1.8m T2 E27	Polished Brass	NEW
8270LAT	1.8m T2 E27	Anthracite	NEW
8270LSB	1.8m T2 E27	Smoked Bronze	NEW



- 3 plate format
- Metal finish ceiling rose and lampholder
- Braided cord flex
- Vintage styled lampholder

6" VINTAGE METAL PENDANT SETS

Code	Size	Model	
8271MB	6" T2 E27	Matt Black	NEW
8271MW	6" T2 E27	Matt White	NEW
8271BC	6" T2 E27	Brushed Chrome	
8271PC	6" T2 E27	Polished Chrome	
8271BN	6" T2 E27	Black Nickel	
8271AB	6" T2 E27	Antique Brass	
8271PB	6" T2 E27	Polished Brass	
8271AT	6" T2 E27	Anthracite	NEW
8271SB	6" T2 E27	Smoked Bronze	NEW

1.8M VINTAGE METAL PENDANT SETS

Code	Size	Model	
8271LMB	1.8m T2 E27	Matt Black	NEW
8271LMW	1.8m T2 E27	Matt White	NEW
8271LBC	1.8m T2 E27	Brushed Chrome	NEW
8271LPC	1.8m T2 E27	Polished Chrome	NEW
8271LBN	1.8m T2 E27	Black Nickel	NEW
8271LAB	1.8m T2 E27	Antique Brass	NEW
8271LPB	1.8m T2 E27	Polished Brass	NEW
8271LAT	1.8m T2 E27	Anthracite	NEW
8271LSB	1.8m T2 E27	Smoked Bronze	NEW





PULL CORD SWITCHES

- 10AX rated
- 2-way
- Approx. 1.5m pull cord

Code	Finish
8300BC	Brushed Chrome
8300PC	Polished Chrome
8300MW	Matt White
8300MB	Matt Black

Code	Finish
8300AB	Antique Brass
8300BN	Black Nickel
8300AT	Anthracite NEW
8300SB	Smoked Bronze NEW



PULL CORD SWITCHES

- Ideal for bathrooms and utility rooms
- With approx. 1.5m pull cord and matching pull cord cap

Code	Model	Qty
SN8290	10A 1-Way (White)	5
SN8300	10A 2-Way (White)	5



CEILING ROSE AND LAMPHOLDER

Code	Model	Qty
SN8260	Ceiling Rose - 3 Plate	10
SN8250	T2 BC Cord Grip Lampholder	20

T2 BC BATTEN HOLDERS

Code	Model	Qty
SN8200	H0 - 3 Terminals (BC)	10
SN8210	Straight Short Skirt (BC) - 3 Terminals	10
SN8220	Angled Short Skirt (BC) - 3 Terminals	10
SN8230	H0 with Ceiling Rose Base (BC)	10



CORD SWITCHES

- 6A 230V
- Double pole switch
- Suitable for 1.5mm² cable

Code	Model	Qty
ST6AWH	White	10
ST6ABK	Black	10



INLINE REWIRABLE CORD DIMMERS

- 1-60W (1-25W LED)
- Trailing-edge dimmer
- Suitable for 0.75mm² twin flat cable

Code	Model
SN81WH	White
SN81BK	Black



MOULDED PENDANT SETS

- 3 Plate format

Code	Size	Qty
SN8270	6" T2 BC	10
SN8280	9" T2 BC	10



EXTENSION LEADS

- With power indicator
- Low profile design

Code	Rating	Model
20042M	13A	4G 2m*
20043M	13A	4G 3m*
20062M	13A	6G 2m*



RCD ADAPTORS / SOCKETS

- Latching type RCD
- RCD trip current of 30mA
- RCD trip speed of <40ms

Code	Rating	Model
RCD001	13A	RCD Safety Adaptor
RCD002	13A	RCD Safety Plug



MAINS ADAPTORS

Code	Rating	Model	Qty
1350	13A	2-Way	10
1375	13A	3-Way (fused)	10
8910	13A	Shaver Adaptor (1A Fuse)	20



SURGE PROTECTED EXTENSION LEADS

- With surge and power indicators

Code	Rating	Model
2004S2M	13A	4G 2m*
2006S2M	13A	6G 2m*
8GTOWER	13A	8G 2m*
12GTOWER	13A	12G 2m*

* Cable length is approximate



NEW RCD
CURVED EDGE
Page 18

NEW RCD
METAL CLAD
Page 145



CARTRIDGE FUSES - DOMESTIC USE

- ASTA approved

Code	Model	Qty
SN3AFUSE	3A Fuse	10
SN5AFUSE	5A Fuse	10
SN13AFUSE	13A Fuse	10
SNMIXEDFUSE	Mixed Fuse Pack (3 x 3A, 3 x 5A, 4 x 13A)	10



PLUG TOPS - DOMESTIC USE

- Screw type cord grip
- BSI Kitemarked

Code	Model	Qty
SN1382	3A Fuse - White	20
SN1381	5A Fuse - White	20
SN1383	13A Fuse - White	20
SN1383BK	13A Fuse - Black	20



STRIP CONNECTORS

- Terminal strips for connecting electrical cables
- Natural colour
- 12-Way
- 380V
- Made of PA66 material (UL94-V2 self extinguishing)
- Operating temperature: -30°C to + 110°C

Code	Model	Qty
SC3PA	3A - 4mm ² Wire Capacity	10
SC5PA	5A - 6mm ² Wire Capacity	10
SC15PA	15A - 10mm ² Wire Capacity	10
SC30PA	30A - 16mm ² Wire Capacity	10
SC60PA	60A - 25mm ² Wire Capacity	10



PLUG TOPS - ROUGH USE

- Clamp type cord grip
- BSI Kitemarked
- TPE cover and nylon base

Code	Model	Qty
SN2135B	13A Fuse - White	20 NEW
SN2135W	13A Fuse - Black	20 NEW



RAISED HEAD ELECTRICAL SCREWS

- M3.5
- Raised head / slotted
- Countersunk

Code	Model	Qty
CSCREW35	35mm	100
CSCREW50	50mm	100
CSCREW75	75mm	100



CAP COVERS

- Spare screw cap covers for Knightsbridge moulded Square Edge and Curved Edge switches and sockets

Code	Model	Qty
CAPCOVER	Screw Cap Covers	100

HOLESAWS

- 4/6 TPI Bi-metal variable teeth
- Suitable for cutting steel, stainless steel, die-cast metals, hardwood floors, plywood, and plastics

Code	Model	Code	Model
HS20MM	20mm	HS70MM	70mm
HS25MM	25mm	HS72MM	72mm
HS32MM	32mm	HS75MM	75mm
HS38MM	38mm	HS80MM	80mm
HS51MM	51mm	HS85MM	85mm
HS60MM	60mm	HS90MM	90mm
HS65MM	65mm		



A2 AND A4 ARBOR

- A2 size Arbor with 11mm hex arbor shank and 6.3mm high speed pilot drill bit included
- A4 size Arbor with 9.5mm hex arbor shank and 6.3mm high speed pilot drill bit included

ARBOR DRILL BITS

- 6.35mm x 75mm

Code	Model
HSARBORL	A2
HSARBORS	A4

Code	Model
HSPILOTDB5	Pack of 5



CAT III 80-1000V AC NON-CONTACT VOLTAGE TESTER

- Light and sound indication
- On / off control
- Power supply: 2 x 1.5V AAA batteries (not included)

Code	Model
TE4B	Voltage Tester NEW



SOCKET TESTER

- Tests for common wiring errors on BS 1363-2 13A sockets
- Simple to use and easy to diagnose faults

Code	Model
TE3	Socket Tester



IP64 2-POLE VOLTAGE TESTERS

- CAT III (690V) / CAT IV (600V) • Self-proving
- Built-in torch function

Code	Model
TE1	LED + LCD Display
TE2	LED



HAVE A QUESTION? CHAT WITH OUR TEAM **INSTANTLY!**

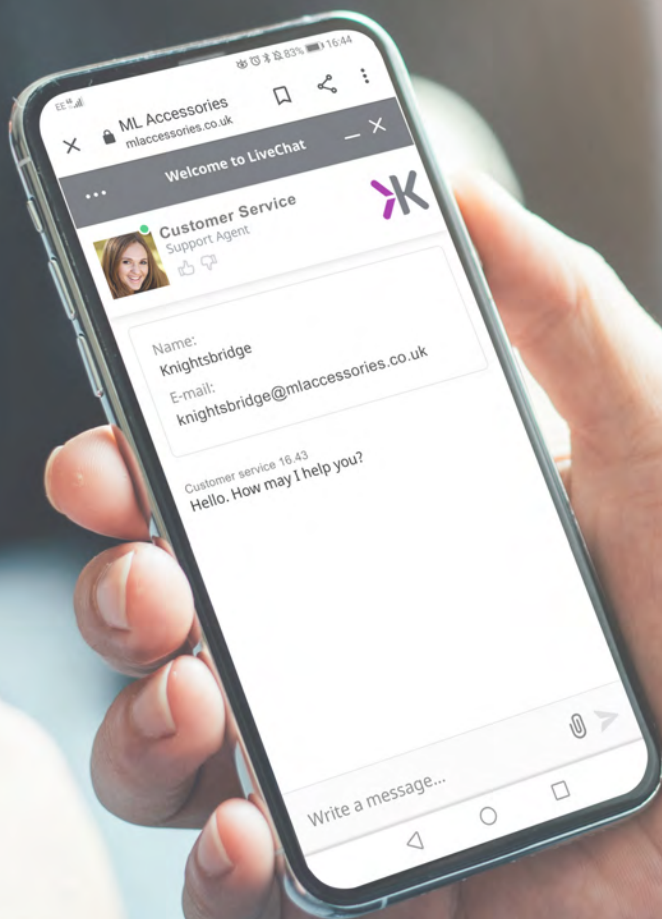

www.mlaccessories.co.uk



110V PLUGS AND SOCKETS

- Earth position - 4h
- Pin configuration - 2P+E
- Terminal capacity - max. 4.0mm² per terminal

110V

IP44

Code	Model	Description
IN001	16A	Plug
IN002	16A	Connector
IN003	16A	Surface Mount Socket*

Code	Model	Description
IN004	16A	Panel Mount Socket
IN005	16A	3-Way Splitter



240V PLUGS AND SOCKETS

- Earth position - 6h
- Pin configuration - 2P+E
- Terminal capacity - max. 4.0mm² per terminal

240V

IP44

Code	Model	Description
IN006	16A	Plug
IN0011	32A	Plug
IN007	16A	Connector
IN0023	32A	Connector
IN008	16A	Surface Mount Socket*
IN0012	32A	Surface Mount Socket*

Code	Model	Description
IN009	16A	Panel Mount Socket
IN0013	32A	Panel Mount Socket
IN0021	16A	Surface Mount Inlet*
IN0022	32A	Surface Mount Inlet*
IN0010	16A	3-Way Splitter

*Includes PG21 to M20 adapter



415V PLUGS AND SOCKETS

- Earth position - 6h
- Pin configuration - 3P+N+E
- Terminal capacity - max. 4.0mm² per terminal

415V

IP44

Code	Model	Description
IN0014	16A	Plug
IN0016	32A	Plug
IN0015	16A	Connector
IN0019	16A	Surface Mount Socket*

Code	Model	Description
IN0020	32A	Surface Mount Socket*
IN0017	16A	Panel Mount Socket
IN0018	32A	Panel Mount Socket



ROTARY ISOLATORS

- 230-415V
- Insulated 4P AC
- Modern rotary switch operation
- M20/M25 cable entries
- Interlocking lid ensures removal in OFF position only
- Handle can be padlocked for safety (padlock not included)

Code	Model
IN0025	20A
IN0026	32A
IN0027	63A

415V

IP65

*Includes PG21 to M20 adapter

WIRELESS DOOR CHIMES

- 58 ringtones to choose from
- Volume control - up to 110dB
- Eye-catching visual alert
- Hassle-free installation - no wiring necessary
- Learning code prevents interference from other wireless transmitters

- Additional plug-in receivers or bell pushes can be added, if desired
- Working frequency: 433MHz
- Working temperature: -20 - 50° C



WIRELESS BATTERY POWERED DOOR CHIME

RECEIVER

- IP44 rated
- Battery powered requires 3 x AAA batteries (not included)
- Wall mountable or free standing
- Power consumption: less than 0.3W
- Range of approx. 150-200m (depending on environment)

BELL PUSH

- IP55 rated
- Includes fixing for mounting
- Battery powered requires 1 x 12V 23A battery (included)
- Power consumption: less than 10mW
- Range of approx. 150-200m (depending on environment)



Code	Model	Finish	
DC010	Wireless Battery Powered Door Chime	White	NEW



WIRELESS BELL PUSH

- IP55 rated
- Door number sleeve
- Can be screw mounted or with double-sided sticker pads
- Battery powered requires 1 x 12V 23A battery (not included)
- Power consumption: less than 10mW
- Range of approx. 150-300m (depending on environment)



Code	Model	Finish	
DCBPB	Bell Push	Black	NEW
DCBPW	Bell Push	White	NEW



DC012



DC013



DC015



DC014

WIRELESS PLUG-IN DOOR CHIMES

RECEIVER

- Indoor use only
- 230V
- Power consumption: less than 0.3W
- Range of approx. 150-200m (depending on environment)

BELL PUSH

- IP55 rated
- Door number sleeve
- Can be screw mounted or with double-sided sticker pads
- Battery powered requires 1 x 12V 23A battery (included)
- Power consumption: less than 10mW
- Range of approx. 150-200m (depending on environment)
- Dual bell push and dual receiver systems available



Code	Model	Finish	
DC012	Wireless Plug-In Door Chime (1 x Bell Push, 1 x Receiver)	Black	NEW
DC013	Wireless Plug-In Door Chime (1 x Bell Push, 1 x Receiver)	White	NEW
DC014	Dual Entrance System (2 x Bell Push, 1 x Receiver)	White	NEW
DC015	Dual Receiver System (1 x Bell Push, 2 x Receivers)	White	NEW



Additional wireless plug-in receiver, suitable for extending your door chime system.

WIRELESS PLUG-IN RECEIVER

- Compatible with DC010, DC012, DC013, DC014, DC015
- Indoor use only
- 230V
- Power consumption: less than 0.3W
- Range of approx. 150-200m (depending on environment)

Code	Model	Finish	
DCRB	Plug-In Receiver	Black	NEW
DCRW	Plug-In Receiver	White	NEW

EASILY ADD ADDITIONAL RECEIVERS OR BELL PUSHES TO ALL KNIGHTSBRIDGE DOOR CHIME PRODUCTS

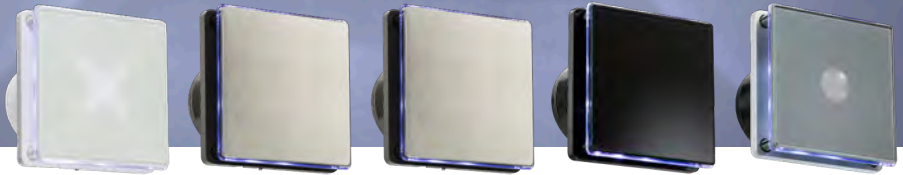
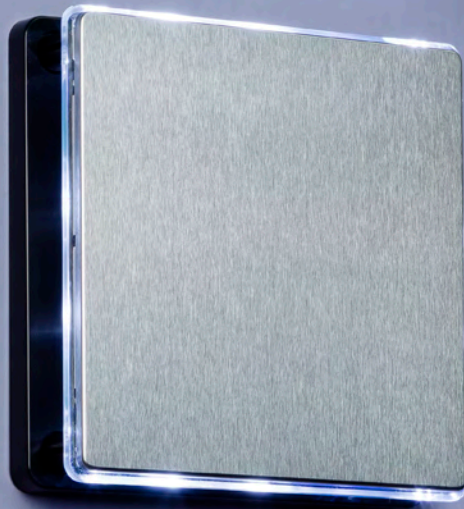

LED EXTRACTOR FAN

230V
50Hz

IPX4



- Ideal solution for removing damp moist air, odours, and airborne pollutants from kitchens, toilets, and bathrooms
- Designed to be installed into walls and ceilings
- Modern design with built-in LED array, easy to wipe clean and convenient to duct over short lengths (2m max.)
- 100mm 4" size
- Profile depth of 40mm

- Built-in overrun timer 2-30 mins
- Low noise level of just 35dBA @ 3m
- Extraction rate of 90m³/hr
- LED lighting effect during activation
- SFP: 0.52
- Compliant with latest Building Regulations (Part F)

Code	Model
EX003T	White
EX004T	Stainless Steel / Black
EX004H	Stainless Steel / Black with Humidistat Function

Code	Model	
EX005T	Black	NEW
EX006T	Grey	NEW



GRID FAN
ISOLATOR
SWITCHES
Page 131



EXTRACTOR FAN

- Ideal solution for removing damp moist air, odours, and airborne pollutants from kitchens, utility rooms, and bathrooms
- Designed to be installed into walls and ceilings
- Slim profile, compact, attractively styled, easy to wipe clean and convenient to duct over short lengths (2m max.)
- 100mm 4" size
- Profile depth 22mm
- Built-in overrun timer 2-30 mins
- Low noise level of just 35dBA @ 3m
- Extraction rate of 90m³/hr
- Compliant with latest Building Regulations (Part F) & (Part L)
- SFP: 0.44

230V
50Hz

IPX2



Code	Model
EX001T	4" Fan with Timer



GRAVITY SHUTTERS

- Prevents backdraft and rain penetration when installed in internal/external walls
- Easy to install, and suitable for use with round ducting
- Prevents objects or vermin entering when the ventilation is not in operation

Code	Model	Description
EX007B	4"	Black
EX007W	4"	White



BACKDRAFT KITS

- Only compatible with EX003/4/5/6 models

Code	Model	Description
EXBDCKIT	100mm/4"	Ceiling Mounted NEW
EXBDWKIT	100mm/4"	Wall Mounted NEW



ALUMINIUM DUCTING KIT

- 3m of expandable aluminium ducting
- Kit includes 2 x jubilee clips

Code	Model
EX4DUCT	4"



FIXED GRILLES

- An easy-fix solution for internal/external walls, with integral fly screen to keep insects out
- Suitable for use with round ducting
- Removeable front grilles allowing access for maintenance and cleaning of the fly screen

Code	Model	Description
EX009B	4"	Black
EX009W	4"	White



SEE PAGES 309 - 335
FOR OUTDOOR
WALL LIGHTS

SENSORS

The Knightsbridge range of sensors offers solutions to a variety of lighting requirements both indoor and outdoor, suitable for commercial and domestic applications

Indoor Sensors	196 - 197
Microwave Sensors	197
Outdoor Sensors	198
Photocell Sensors / Batten Microwave Sensor	199

SMART RECESS MOUNT PIR SENSOR

- 24/7 monitoring - receive instant alerts when there is unexpected movement in your home
- Easy installation: no gateway product required connects via Wi-Fi and SmartKnight app
- Automate devices (such as lights) to turn on/off if motion is detected

Field of detection: 360°



Code	Range*	Function	Max. Load	Cut-out	
OSPIRKW	4.5m	Smart	2000W Incandescent / 400W/600VA Energy Saving or LED	68mm	NEW



OS0016



OS0019



OS009

RECESS MOUNTED INDOOR PIR SENSORS

Field of detection: 360°

230V
50Hz

IP20

Code	Range*	Function	Max. Load	Cut-out
OS0016	2-20m	Adjustable Lux / Adjustable Time (10s - 10mins)	2000W Incandescent / 1000W LED	80mm
OS0019	8m	Adjustable Lux / Adjustable Time (30s - 30mins)	2000W Incandescent / 200W LED	38mm
OS009	6m	Adjustable Lux / Adjustable Time (10s - 8mins)	1200W Incandescent / 300W LED	62mm

SURFACE MOUNTED INDOOR PIR SENSOR

Field of detection: 360°



230V
50Hz

IP20

Code	Range*	Function	Max. Load
OS0011	6m	Adjustable Lux / Adjustable Time (10s - 8mins)	1200W Incandescent / 300W LED

* When mounted at 2.4 metres high



NETPIRGY



NETPIRSBK



NETPIRSWH
shown with NET2GWH
see page XX for other
modular frame options

MODULAR PIR SENSORS

- Operation: passive infrared
- Time pre-set: 3mins.
- NETPIRSxx with override allows Auto or ON control
- Suitable for 47mm back box
- Lux sensitive and time operation fixed
- Live and Neutral wiring required

Field of detection: 120°

230V
50Hz

IP20

Finishes: to indicate desired finish,
please replace 'xx' with suffix WH (white),
GY (grey), or BK (black) – e.g. NETPIRBK

Code	Range	Model	Max. Load	
NETPIRxx	5m	PIR Sensor Module 50x50mm	200W Incandescent and 100W LED	NEW
NETPIRSxx	5m	PIR Sensor Module w/switch 50x50mm	200W Incandescent and 100W LED	NEW

FLUSH FIX / SURFACE MOUNT INDOOR PIR SENSORS

- Minimum mounting box depth 25mm

Field of detection: 120° (must have L and N feed)



230V
50Hz

IP20

Code	Range	Function	Max. Load
PIR0901	5m	Adjustable Lux / Adjustable Time (1-16mins)	2400W Incandescent / 720W LED
PIR0901S	5m	Adjustable Lux / Adjustable Time (1-16mins) with Override Switch	2400W Incandescent / 720W LED

MICROWAVE SENSORS

- These products should be installed into an IP rated enclosure or luminaire



MSENSOR



OS008

230V
50Hz

IP20

Code	Model	Range	Function	Max. Load	Type
MSENSOR	5.8GHz	2-8m	Adjustable Lux / Adjustable Time (10s - 30m)	1000W Incandescent 500W LED	Dial Setting
OS008	5.8GHz	2-8m	Adjustable Lux / Adjustable Time (8s - 12mins)	250W Incandescent 250W LED	DIP Switch Setting

CORNER MOUNTABLE

OUTDOOR PIR SENSORS

- Completely adjustable head unit for optimum positioning
- Easy to install – wire to the rear mounting plate then simply click the PIR unit into the mounting plate
- Versatile mounting options including wall, ceiling, or corner mounting
- Includes shrouding kit for shielding parts of the PIR to prevent accidental activation
- Automatic operation or manual override function



OS001

OS001B

230V
50Hz

IP55

Field of detection: 200°

Code	Range*	Function	Max. Load	Colour
OS001	12m	Override Function / Adjustable Lux Adjustable Time (3s - 30mins)	2000W Incandescent / 225W LED	White
OS001B	12m	Override Function / Adjustable Lux Adjustable Time (3s - 30mins)	2000W Incandescent / 225W LED	Black

OUTDOOR PIR SENSORS

- Adjustable head unit (up/down)
- Wall or ceiling mountable



OS004

OS004B

230V
50Hz

IP44

Field of detection: 180°

Code	Range*	Function	Max. Load	Colour
OS004	12m	Adjustable Lux / Adjustable Time (10s - 8mins)	1200W Incandescent / 300W LED	White
OS004B	12m	Adjustable Lux / Adjustable Time (10s - 8mins)	1200W Incandescent / 300W LED	Black

OUTDOOR PIR SENSORS (COMPACT)

- Adjustable head unit
- Wall or ceiling mountable



OS0014

OS0014B

230V
50Hz

IP44

Field of detection: 180°

Code	Range*	Function	Max. Load	Colour
OS0014	12m	Adjustable Lux / Adjustable Time (10s - 15mins)	2000W Incandescent 1000W LED	White
OS0014B	12m	Adjustable Lux / Adjustable Time (10s - 15mins)	2000W Incandescent 1000W LED	Black

* When mounted at 2.4 metres high

OS006



OS006B

OUTDOOR PHOTOCELL SENSOR

- Dusk-to-dawn photocell timer. Ideal for controlling outdoor lighting during the evenings for security and convenience
- Suitable for shop window display lighting or advertising systems
- Wall mountable - easy installation

230V
50Hz

IP55

Code	Function	Max. Load	Colour
OS006	Ambient Light Memory Function - 2/4/6/8hr Durations	1000W Incandescent / 200W LED	White
OS006B	Ambient Light Memory Function - 2/4/6/8hr Durations	1000W Incandescent / 200W LED	Black NEW

LED
COMPATIBLE



OSPCKIT



TRPCKIT

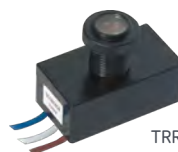

TRRPC

230V
50Hz

PHOTOCELL SENSORS

Code	Function	IP Rating	Max. Load	Colour
TRPCKIT	NEMA Photocell Kit - Dusk-to-Dawn Sensor	IP54	2000W Tungsten Halogen, 2 x 400W SON 3 x 150W HQI, 1800vA	Black
TRRPC	Remote Miniature Photocell		2000W Tungsten Halogen, 2 x 400W SON 3 x 150W HQI, 1800vA	Black
OSPCKIT	10A Photocell Control Sensor	IP66	1000W Incandescent / 300W LED	Black NEW

BATTEN MICROWAVE SENSOR

- IP65 pre-wired microwave sensor
- Ideal for battens or non-corrosives with 20mm conduit entry
- Adjustable lux, time, and sensitivity



Code	Function	Range*	Max. Load
OS020	Adjustable Lux / Adjustable Time (5s - 10mins)	4-6m	400W LED

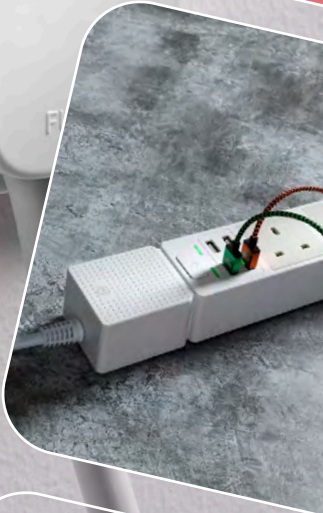



SMART HOME

Smart lighting and wiring accessories that are easy to control via the SmartKnight app

Smart Switched Socket	205
Smart Outdoor Switched Socket	206
Smart Plug / Smart Extension Lead	207
Smart Sensors	208
Smart Camera	209
Smart Downlights	210 - 211
Smart CCT Led Panel Downlights	212
Smart LED Flex Controller	213
Smart Lamps	214



EASY FOR THE SIMPLE FOR TH

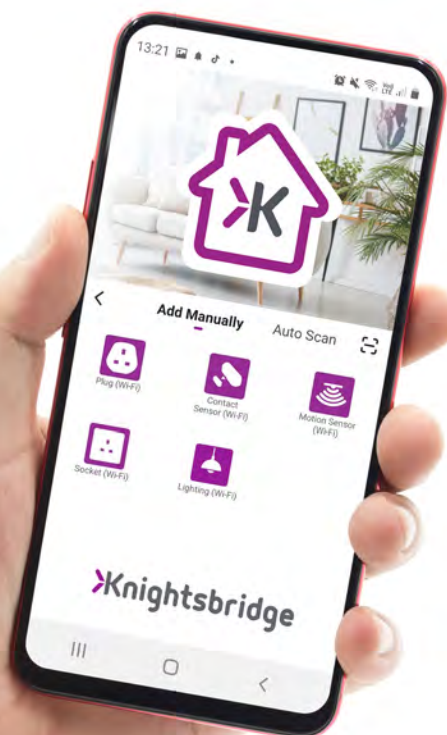

With Knightsbridge, creating a smart home couldn't be simpler!

Our SmartKnight app enables users to control their appliances via their smartphone, including on/off, dimming, colour adjustment, and much more.

Please refer to the individual product listings within this section, or our website, for full details on what each smart product is capable of.



Download



Add Device



Enjoy

Our smart products are designed for easy installation, with features such as push-fit terminals on downlights and retrofit capabilities on smart sockets

USER, THE INSTALLER

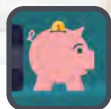

NO HUB REQUIRED

Products connect directly via Wi-Fi enabling global remote access.

No space and money wasted on additional hubs / gateway devices

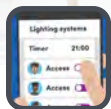

TIMERS

Set up schedules within the home using the timer function to automate when devices turn on/off.



VOICE CONTROL

Voice control works with *Hey Google* or *Amazon Alexa*



GEOFENCING

Don't come home to darkness; program lights to automatically turn on/off based on your GPS location



SCENES

Utilise preset scenes such as 'Movie', or create your own.

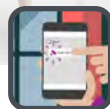

SECURITY

Instant security alerts to your mobile device

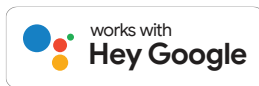

Amazon, Alexa and all related logos are trademarks of Amazon.com, Inc. or its affiliates.

Google is a trademark of Google LLC.

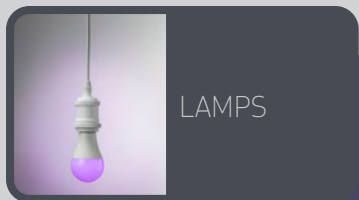

LAMPS

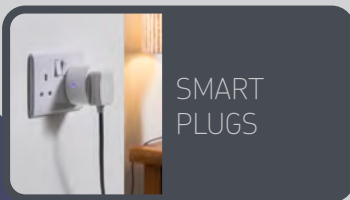

SMART PLUGS

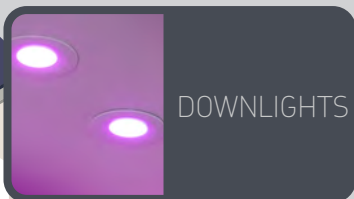

DOWNLIGHTS

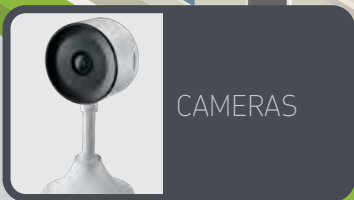

CAMERAS

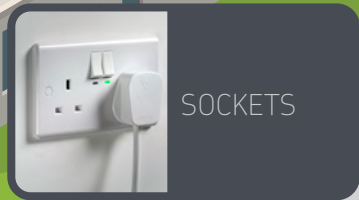

SOCKETS

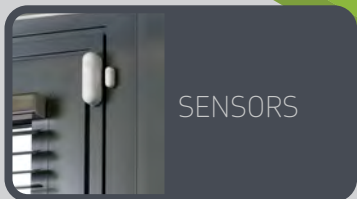

SENSORS



OUTDOOR SOCKET



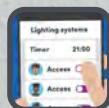

TIMERS



NO HUB REQUIRED



GEOFENCING



VOICE CONTROL



ANTI-MICROBIAL

13A 2G SMART SWITCHED SOCKET

- Control up to 2 appliances
- Manually override by using the switches on the socket
- Power monitoring function
- White moulded designs with antimicrobial properties
- Minimum mounting box depth: 25-35mm (dependent on wiring conditions)
- See pages 6 and 16 for full technical product breakdowns

Code	Model
SN9KW	Square Edge
CU9KW	Curved Edge NEW

FOR MATCHING
SQUARE EDGE
PRODUCTS

Page 8



FOR MATCHING
CURVED EDGE
PRODUCTS

Page 18



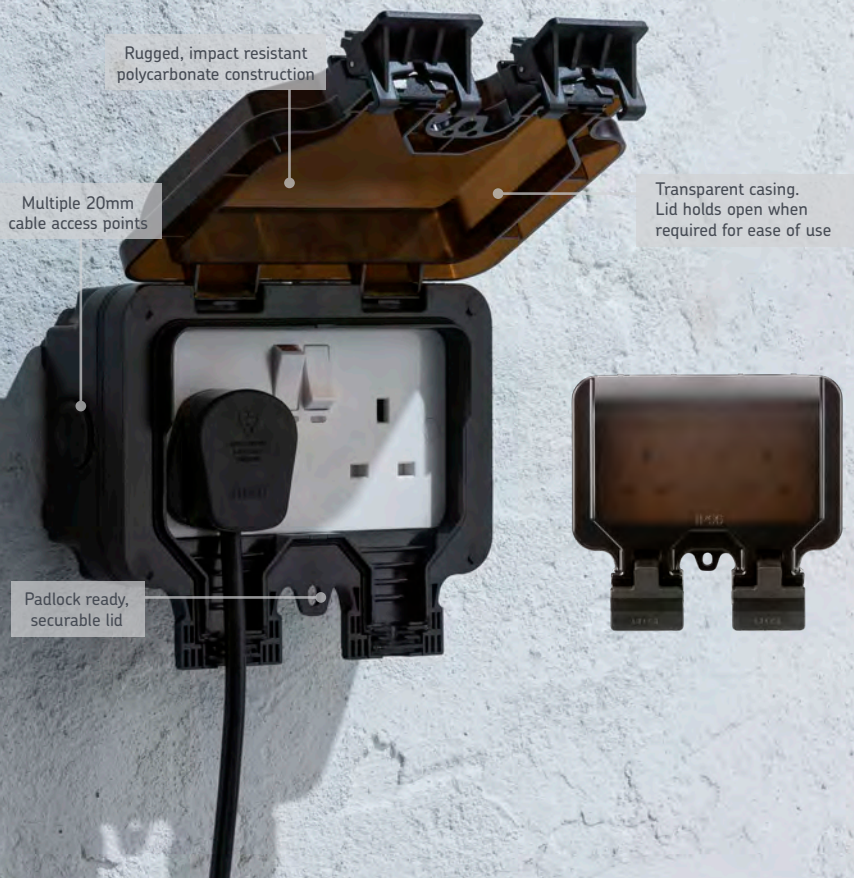

IP66 2G SMART OUTDOOR SWITCHED SOCKET

- Controls up to 2 outdoor appliances
- Manually override by using the switch on the socket
- Rugged outdoor enclosure
- Range: 20m-40m (depending on Wi-Fi signal coverage)

Code	Model
OP9KW	IP66 2G Outdoor Switched Socket

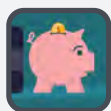

**NO HUB
REQUIRED**

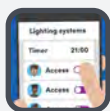

TIMERS

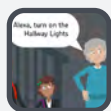

**VOICE
CONTROL**



GEOFENCING



10A 3G SMART EXTENSION LEAD WITH QUAD USB CHARGER

- Control up to 3 appliances and the quad USB charger block
- Manually override by using the switch on the extension lead
- Surge protected
- 1.5m cable

Code	Model
3GKW	Smart Extension Lead



16A SMART PLUG

- Controls 1 appliance
- Manually override by using the switch on the plug
- Power monitoring function
- Compact design

Code	Model
1GAKW	Smart Plug



**NO HUB
REQUIRED**

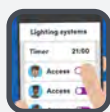

TIMERS

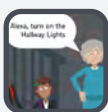

**VOICE
CONTROL**



GEOFENCING



SMART RECESS MOUNT PIR SENSOR

- 24/7 monitoring - receive instant alerts when there is unexpected movement in your home
- Easy installation: no gateway product required connects via Wi-Fi and SmartKnight app
- Automate devices (such as lights) to turn on/off if motion is detected

Field of detection: 360°

Code	Range	Function	Max. Load	Cut-out
OSPIRKW	4.5m	Smart	2000W Incandescent / 400W/600VA Energy Saving or LED	68mm NEW



SMART MOTION SENSOR

- Compact size - just 64 x 64 x 30mm for discreet positioning
- Detects motion up to 4.5m distance with a detection angle of 100° when wall-mounted and 90° when ceiling mounted
- Easy Installation: simply mount to wall or ceiling with the magnetic mount

Code	Model
OSMKW	Motion Sensor



SMART ENTRY SENSOR

- Compact size for discreet positioning around door and window frames
- Simple do-it-yourself installation, with adhesive pads (included)

Code	Model
OSEKW	Entry Sensor





SMART SECURITY CAMERA

Plug and play SmartKnight indoor fixed 1080p camera with local and cloud storage.

- Built-in 2-way audio system, enabling listening and 2-way conversations
- On-board SD card storage (SD card not provided)
- Cloud recording available (subscription plan required)

Code	Model	
CAMFIX01	Security Camera	NEW



SECURITY & AUTOMATION

Apply sensor to doors and windows for peace of mind. 24/7 push notifications on a door or window breach. Combine with other products to switch on a light when activated

MONITORING

Use sensors to monitor a household's activities i.e. Front door opened/closed @ 16:00pm.

EASY INSTALLATION

No gateway product required – connects via Wi-Fi and SmartKnight app

LOWER POWER CONSUMPTION

Battery life of up to 1 year based on 20 activations per day



**NO HUB
REQUIRED**



SECURITY



**FOR
BEZEL
OPTIONS**
PAGE 239



**FIRE-RATED TO
30, 60, 90 MINUTES**

SEE PAGE 224 FOR FULL DETAILS

- Loop-in / loop-out terminals on driver (valid for RW6KW only)
- Separate driver with plug to socket connection for easy installation

SMART FIRE-RATED LED DOWNLIGHTS

- Both models: Adjust the colour temperature from warm white to cool white and everything in between (3000K – 5000K)
- RW6KRGBW only: Adjust the RGB colour, with over 16 million colour options
- Fire-rated to 30, 60, 90 minutes

230V
50Hz

IP65

VIA APP
ONLY

LAMP
INCLUDED

IC^{*}
RATED

Construction: Aluminium & steel

Driver: Included

Lamp type: LED

Beam angle: 40°

Cut-out ø	Overall ø	Minimum Void	(mm)
72	85	121	

Code	Wattage	Colour	Lumens
RW6KW	6W	CCT Adjustable ● ●	510lm (at 3000K)
RW6KRGBW	6W	RGB + CCT Adjustable ● ● ● ● ● ● ● ● ● ●	440lm (at 3000K)

* With mineral wool style insulation only, please see page 224 and product instructions for more information

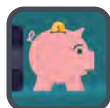

**NO HUB
REQUIRED**

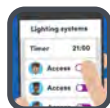

TIMERS



**VOICE
CONTROL**



GEOFENCING



SCENES



SMART RGBW + CCT ADJUSTABLE LED DOWNLIGHT

- Adjust the colour temperature from warm white to daylight and everything in between (3000K – 6500K)
- Adjust the RGB colour, with over 16 million colour options
- Push-fit terminals for easy installation

Construction: Aluminium

Driver: Included

Lamp type: LED

Beam angle: 100°



230V 50Hz	IP44	VIA APP ONLY	LAMP INCLUDED	IC RATED
----------------------	-------------	--------------	---------------	----------

Cut-out ø	Overall ø	Minimum Void	(mm)
88	110	120	

Code	Wattage	Colour	Lumens
WD12RGBW	12W	RGB + CCT Adjustable ●●●●●●●○	875 – 1070lm
WD12BC	Brushed Chrome Bezel		



* With mineral wool style insulation only, please see page 224 and product instructions for more information



**NO HUB
REQUIRED**

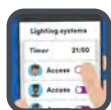

TIMERS



**VOICE
CONTROL**



GEOFENCING



SCENES



SMART CCT ADJUSTABLE LED PANEL DOWNLIGHTS

Construction: Polycarbonate

Driver: Included

Lamp type: LED

- Adjust the colour temperature from warm white to daylight and everything in between (3000K – 6000K)



FOR BEZEL OPTIONS SEE PAGE 389



- **LOW PROFILE 15MM**
- **FLEXIBLE MOUNTING**
SURFACE OR RECESS MOUNTED
(on ceilings and walls)

Minimum Void (mm)

50



Code	Wattage	Overall ø	Min/Max Cut-out	Colour	Lumens
CPL18WCT	18W	217mm	55 – 175mm	CCT Adjustable ● ●	1100 – 1400lm
CPL24WCT	24W	290mm	55 – 250mm	CCT Adjustable ● ●	1700 – 2100lm

230V
50Hz

IP20



**NO HUB
REQUIRED**

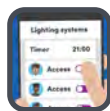

TIMERS



**VOICE
CONTROL**



GEOFENCING



SCENES



LED STRIP LIGHTING NOT INCLUDED



SMART LED FLEX CONTROLLER

- Compatible with single colour, CCT, RGB, and RGBW flex
- Enables users to adjust the colour temperature of their LED flex, via the SmartKnight app
- RGB and RGBW LED flex only: enables users to adjust the RGB colour via the SmartKnight app

Code	Model
LEDFWIFI	12V / 24V



FOR FULL
LED FLEX
RANGE
SEE PAGES
298 - 304



**NO SUB
REQUIRED**

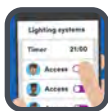

TIMERS



**VOICE
CONTROL**



GEOFENCING



SCENES



GLS9ESKW



GLS9BCKW



CL5KW



GU5KW



SMART LAMPS

- RGB and colour temperature adjustable, changeable via Wi-Fi app
- Dimmable via app
- CCT adjustable - 2700K to 6500K



Code	Model	
CL5KW	5W RGB + CCT SES Candle Lamp - 38mm	NEW
GU5KW	5W RGB + CCT GU10 Lamp	NEW
GLS9ESKW	9W RGB + CCT ES GLS Lamp - 60mm	NEW
GLS9BCKW	9W RGB + CCT BC GLS Lamp - 60mm	NEW



NO HUB
REQUIRED

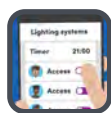

TIMERS



VOICE
CONTROL



GEOFENCING



SCENES



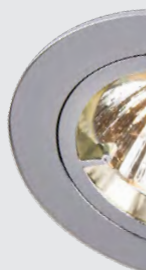

DOMESTIC INTERIOR DOWNLIGHTS

Downlights ideal for domestic spaces, such as living rooms, kitchens and bathrooms. This diverse range includes Smart and Fire Rated integrated LED options

Recessed Downlights 218 - 221

Hole Converter Kits / Fire Hood / LED Emergency Pack 222

Fire Rated

GU10 Fire Rated Downlights 226 - 229

Evolve GU10 Fixed and Tilt Downlights 230 - 231

Integrated LED Fire Rated

5W LED Fire Rated Downlights 232 - 233

5W/8W SpekroLED® Fire Rated Downlights 234 - 237

6W LED Fire Rated Downlights 238 - 239

8W Valknight LED Fire Rated Fixed and Tilt Downlights 240 - 241

8W Proknight LED Fire Rated Fixed and Tilt Downlights 242 - 243

7W Fireknight LED Fire Rated Fixed and Tilt Downlights 244 - 245





RECESSED DOWNLIGHTS

FIXED DOWNLIGHTS

Construction: Pressed steel
Driver / Transformer: Required
Lamp type: MR16



Cut-out Ø	Overall Ø	Minimum Void	Recessed Depth	(mm)
58	80	110	92	

Code	Finish
L02B1	Brass
L02BK1	Black
L02C1	Chrome

Code	Finish
L02CBR1	Brushed Chrome
L02W1	White

TILT DOWNLIGHTS

Construction: Pressed steel
Driver / Transformer: Required
Tilt Angle: 15°
Lamp type: MR16



Cut-out Ø	Overall Ø	Minimum Void	Recessed Depth	(mm)
75	105	120	70	

Code	Finish
LG06C	Chrome
LG06CBR	Brushed Chrome

Code	Finish
LG06W	White

EYEBALL DOWNLIGHTS

Construction: Pressed steel
Driver / Transformer: Required
Tilt Angle: 15°
Lamp type: MR16



Cut-out Ø	Overall Ø	Minimum Void	Recessed Depth	(mm)
85	100	100	60	

Code	Finish
LE04C1	Chrome
LE04W1	White

FIXED DOWNLIGHTS

Construction: Pressed steel
Driver / Transformer: Required
Lamp type: MR11 (35W max.)



Cut-out Ø	Overall Ø	Minimum Void	Recessed Depth	(mm)
42	60	120	70	

Code	Finish
L01C	Chrome
L01CBR	Brushed Chrome

Code	Finish
L01W	White



RECESSED DOWNLIGHTS

FIXED TWIST & LOCK DOWNLIGHTS

Construction: Die-cast aluminium

Driver: Driver / Transformer: Required for MR16 only

Lamp type: GU10 LED / MR16



Cut-out Ø	Overall Ø	Minimum Void	Recessed Depth	(mm)
70	79	140	90	

Code	Finish
RD1B	Brass
RD1C	Chrome

Code	Finish
RD1CBR	Brushed Chrome
RD1W	White

TILT TWIST & LOCK DOWNLIGHTS

Construction: Die-cast aluminium

Driver: Driver / Transformer: Required for MR16 only

Tilt angle: 25°

Lamp type: GU10 LED / MR16



Cut-out Ø	Overall Ø	Minimum Void	Recessed Depth	(mm)
80	94	150	100	

Code	Finish
RD2B	Brass
RD2C	Chrome

Code	Finish
RD2CBR	Brushed Chrome
RD2W	White

SWIVEL & SCOOP DOWNLIGHTS

Construction: Die-cast aluminium

Driver / Transformer: Required

Tilt angle: 80°

Lamp type: MR16



Cut-out Ø	Overall Ø	Minimum Void	Recessed Depth	(mm)
110	129	130	78	

Code	Finish
SWS01C	Chrome

Code	Finish
SWS01W	White

BATHROOM DOWNLIGHTS

Construction: Die-cast aluminium

Driver: Not required

Lamp type: GU10 LED



Cut-out Ø	Overall Ø	Minimum Void	Recessed Depth	(mm)
64	84	140	90	

Code	Finish
RDSHC	Chrome
RDSHCBR	Brushed Chrome
RDSHW	White



For lamps,
see page
443

HOLE CONVERTER KITS

- Complete with MR16 and GU10 LED lampholders and bridge



Cut-out Ø	Overall Ø	(mm)
78 to 120	140	

Code	Finish
HCBC	Brushed Chrome
HCC	Chrome
HCW	White



FIRE HOOD

- Made with breathable intumescent material
- Allows heat from the lamp to be dissipated preventing the terminal block and downlight from overheating
- The fire hood is flexible and light and can be used in plasterboard, concrete, or suspended ceilings
- 60 minute rated

Height	Overall Ø	(mm)
150	150	

Code	Finish
FR150	White



LED EMERGENCY PACK

- Pre-wired with easy-fix connectors and LED charge indicator
- For maintained and non-maintained use

Construction: Polycarbonate
Lamp type: GU10 LED (6W Max.)

Cut-out Ø	(mm)
55	

Code	Finish
EMGUKIT1	White



230V
50Hz

IP20



Knightsbridge

FIRE-RATED DOWNLIGHTS



GUIDE TO CERTIFICATIONS

With over 20 years' experience developing and testing fire-rated downlights, Knightsbridge has established itself as one of the UK's leading manufacturers for GU10 canisters and integrated LED downlights.

To help you find the perfect fit for the job, we have pulled together this handy guide to the different types of certifications that you will see referenced throughout this section.

FIRE-RATED – 30/60/90 MINS

There are separate 30 minute, 60 minute and 90 minute tests for fire rated downlights. In each test the ceiling configuration is different with ceiling thickness and joist centre spacing altered to simulate typical 30, 60, 90-minute ceiling constructions.

IC RATED DOWNLIGHTS

To date, installation of traditional downlights has been at odds with the requirements of Parts L1 A and B of the Building Regulations which are focusing on energy efficiency and energy saving.

The problem was – and remains for many standard

products – that holes need to be cut in ceilings for installation. This compromises the fire and acoustic barrier of the ceiling and also results in heat loss and moisture transfer. Furthermore, to promote heat dissipation from downlights, reduce fire risk and extend lamp life, insulation is also removed from around and above the units; further compromising the thermal performance of the space.

While most fire-rated downlights now address the issues regarding fire, acoustics and moisture transfer, they still can't be covered by insulation – still creating thermal bridges that impact the energy efficiency of the ceiling and roof structures.

Knightsbridge insulation contact (IC) rated downlights solve this issue; these innovative products allow glass or rock mineral wool insulation to be laid, without gaps, directly over the units. Clever construction allows heat to dissipate through the ventilated body while maintaining the structural integrity of the ceiling and helping conformity with Building Regulations.

JOIST TYPES

Recently, developers have changed their construction methods in respect of joists and ceiling configuration, which means that tests and assessments achieved with old construction methods do not achieve compliance with the new engineered joist designs. Here's a quick guide to the different joist types:



I-JOIST

Commonly found in new build properties. Due to the reduced amount of materials used in the joist, the product can experience a quicker burn-through rate if fire penetrates into the ceiling void.



WEB JOIST

A newer type of joist, metal web joists include a combination of timber flange and a steel web, which allows them to be used over a larger area.



TIMBER JOIST

Currently the most common joist, solid timber joists are traditionally found in existing domestic floor construction and are manufactured from timber only. All Knightsbridge fire-rated downlights are tested to 30, 60, and 90 minutes on these joists.



FULL PRODUCT GUIDE

Please refer to the below chart below for a quick summary of our ranges and their levels of IC and fire-rated certification:

Code	Downlight Range	Pages	Timber-Joist	I-Joist*	Web-Joist	IC Rated
VFCFxx	GU10	226 - 227	30-60-90 minutes	30 minutes		Yes
VFRxx	GU10 IC	228 - 229	30-60-90 minutes	30 minutes		Yes
EVOxx	Evolve GU10 IC	230 - 231	30-60-90 minutes	30 minutes		Yes
CFR5xx	5W Integrated LED	232 - 233	30-60-90 minutes	30 minutes	30 minutes	No
SPEK2W4CCT	SpektrOLED®	234 - 237	30-60-90 minutes	30 minutes	30 minutes	Yes
RW6xx	6W Integrated LED	238 - 239	30-60-90 minutes			Yes
VFRIC8xx	Valknight 8W Integrated LED	240 - 241	30-60-90 minutes	30 minutes		With IC cage only
VFR8xx	Proknight 8W Integrated LED	242 - 243	30-60-90 minutes	30 minutes		No
VFRCOBxx	FireKnight 7W Integrated LED	244 - 245	30-60-90 minutes	30 minutes		No

*Knightsbridge tests against staircraft style i-joists only

This content is for information purposes only. Full technical guidance should be taken from the products datasheet / installation guide, which can be found at maccessories.co.uk.



FIXED GU10 DOWNLIGHTS

Construction: Pressed steel

Driver: Not required

Lamp type: GU10 LED (Max. 6W)



- Fast-fix installation
- Supplied with bezel which can be easily removed for decorating and painting
- Available in fixed, tilt, and IP65 options, and comes in a choice of popular finishes
- Product includes screwless terminal block; tool-free installation; loop in / loop out, fast-fix fitting

Cut-out Ø	Overall Ø	Minimum Void	Recessed Depth	(mm)
65	85	126	100	

Code	Finish
VFCFBC	Brushed Chrome
VFCFC	Chrome
VFCFW	White



*6W LED lamp only

*With mineral wool style insulation only, please see page 224 and product instructions for more information

TILT GU10 DOWNLIGHTS

Construction: Pressed steel
Driver: Not required
Lamp type: GU10 LED (Max. 6W)
Tilt: 15°



Cut-out Ø	Overall Ø	Minimum Void	Recessed Depth	(mm)
80	91	138	113	

Code	Finish
VFCFTBC	Brushed Chrome
VFCFTC	Chrome
VFCFTW	White



IP65 GU10 DOWNLIGHTS

Construction: Pressed steel
Driver: Not required
Lamp type: GU10 LED (Max. 6W)



Cut-out Ø	Overall Ø	Minimum Void	Recessed Depth	(mm)
69	84	142	117	

Code	Finish
VFCFIPBC	Brushed Chrome
VFCFIPC	Chrome
VFCFIPW	White

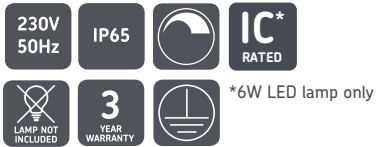

FIRE-RATED



*Knightsbridge tests against staircraft style i-joists only





FIRE-RATED DOWNLIGHTS

FIXED GU10 IC DOWNLIGHTS

Construction: Pressed steel & aluminium

Driver: Not required

Lamp type: GU10 LED

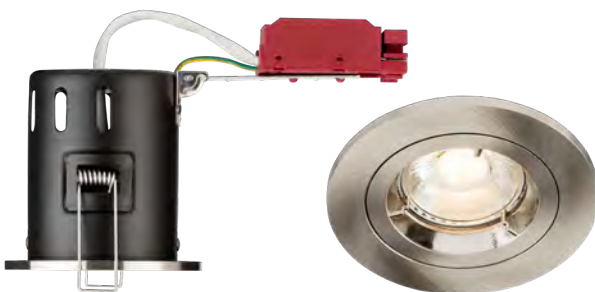

Cut-out Ø	Overall Ø	Minimum Void	Recessed Depth	(mm)
72	87	160	105	

Code	Finish
VFRDGICB	Brass
VFRDGICC	Chrome
VFRDGICCBR	Brushed Chrome
VFRDGICW	White



TILT GU10 IC DOWNLIGHTS

Construction: Pressed steel & aluminium

Driver: Not required

Lamp type: GU10 LED

Tilt: 15°



Cut-out Ø	Overall Ø	Minimum Void	Recessed Depth	(mm)
84	101	160	105	

Code	Finish
VFRSGICB	Brass
VFRSGICC	Chrome
VFRSGICCBR	Brushed Chrome
VFRSGICW	White



*With mineral wool style insulation only, please see page 224 and product instructions for more information

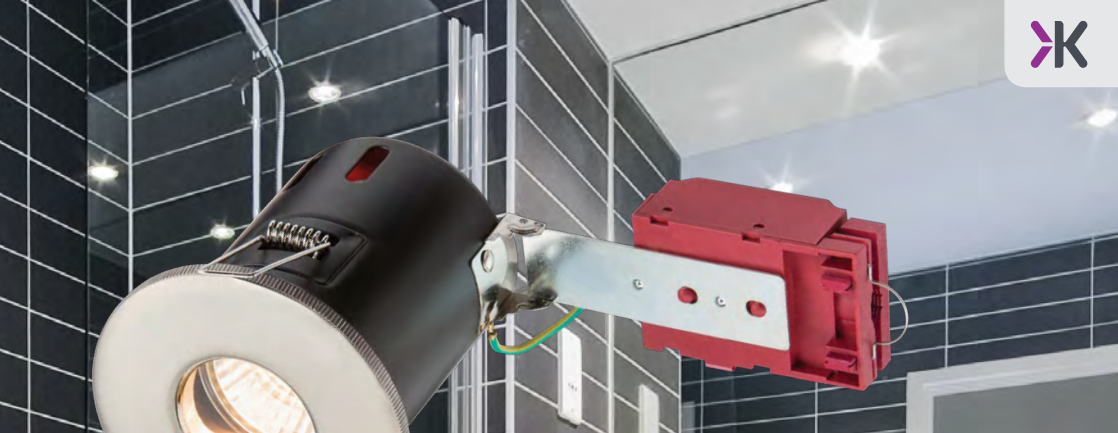

GU10 IC SHOWER DOWNLIGHTS

Construction: Pressed steel & aluminium

Driver: Not required

Lamp type: GU10 LED

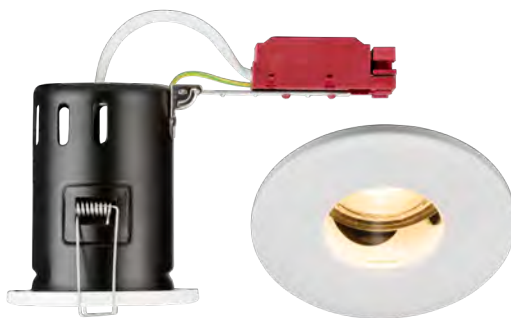

Cut-out Ø	Overall Ø	Minimum Void	Recessed Depth	(mm)
70	87	175	118	

Code	Finish
VFRSHGICB	Brass
VFRSHGICC	Chrome

Code	Finish
VFRSHGICCBR	Brushed Chrome
VFRSHGICW	White



*With mineral wool style insulation only, please see page 224 and product instructions for more information



FIRE-RATED



*Knightsbridge tests against staircraft style i-joists only



FIRE-RATED DOWNLIGHTS

- 230V 50W max. fire-rated downlight can
- Compatible with all standard GU10 LED lamps
- EASY-fix loop in / loop out screwless terminal
- Dimmable subject to light source
- Interchangeable tilt and fixed bezels



(Shown with bezel – bezel not included)

EVOLVE IC FIXED STANDARD CAN

Construction: Pressed steel

Driver: Not required

Lamp type: GU10 LED

Cut-out Ø	Overall Ø	Minimum Void	Recessed Depth	(mm)
68	82	170	119	

Code	Finish
EVOICF	Black

230V
50Hz

IP20



EVOLVE FIXED BEZELS

Code	Finish
EVOABF	Antique Brass
EVOBCF	Brushed Chrome
EVOBKF	Black
EVOBRF	Brass
EVOCHF	Chrome
EVOGMF	Gunmetal
EVOWHF	White

EVOLVE HOLE CONVERTERS

Construction: Pressed steel
Compatible with EVOICF fixed downlights

Overall Ø	Cut-out Box	(mm)
180	80-135	

Code	Finish
EVOCBC	Brushed Chrome
EVOCC	Chrome
EVOCW	White

EVOLVE IP65 BEZELS

Code	Finish
EVOIPBC	Brushed Chrome
EVOIPCH	Chrome
EVOIPWH	White



*With mineral wool style insulation only, please see page 224 and product instructions for more information

EVOLVE IC TILT DOWNLIGHT

Construction: Pressed steel
Driver: Not required
Lamp type: GU10 LED



(Shown with bezel - bezel not included)

Cut-out Ø	Overall Ø	Minimum Void	Recessed Depth	(mm)
80	90	170	119	

Code	Finish
EVOICT	Black



EVOLVE TILT BEZELS

Overall Ø	(mm)
90	



Code	Finish
EVOABT	Antique Brass
EVOBCT	Brushed Chrome
EVOBKT	Black
EVOBRT	Brass

Code	Finish
EVOCHT	Chrome
EVOGMT	Gun Metal
EVOWHT	White

*With mineral wool style insulation only, please see page 224 and product instructions for more information



For lamps, see page 443

FIRE-RATED



TIMBER JOIST



30/60/90 mins



I- JOIST



30 mins

*Knightsbridge tests against staircraft style i-joists only



INTEGRATED LED DOWNLIGHTS



Integrated SMD LED lamp

FIRE-RATED



TIMBER JOIST



30/60/90 mins



WEB JOIST



30 mins



I-JOIST



30 mins

*Knightsbridge tests against staircraft style i-joists only

EASY INSTALL



Push-fit terminals with loop-in / loop-out

AVAILABLE IN:

Warm white / Cool white / Daylight

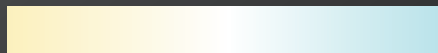

4 BEZEL FINISHES AVAILABLE

Sold separately





5W INTEGRATED LED DOWNLIGHTS

- Push-fit terminals with loop-in / loop-out for easy wiring
- Supplied with white bezel as standard

Construction: Pressed steel

Driver: Integral

Lamp type: LED

Cut-out Ø	Overall Ø	Minimum Void	(mm)
55	84	100	

Code	Wattage	Colour	CCT	Lumens
CFR5WW	5W	Warm White	3000K	570lm
CFR5CW	5W	Cool White	4000K	570lm
CFR5DL	5W	Daylight	5500K	675lm NEW



BEZELS

Construction: ABS

Overall Ø	(mm)
87	

Code	Finish
CFRB	Brass
CFRBC	Brushed Chrome
CFRPC	Polished Chrome
CFRMB	Matt Black NEW





Stylish interchangeable bezels

Low profile
(42mm minimum void)



Professional
795lm output

High-efficiency
dimmable driver

Robust steel
construction

SpektoLED®

THE PERFECT FIT

SpektoLED® is an LED downlight designed with budget in mind and with a passion for choice. With 8 user definable lighting outputs and 5 bezel finishes to choose from, this downlight provides a true 40-in-1 lighting solution like no other.

Wattage and CCT adjustable

First-fix / second-fix detachable electrical connector system

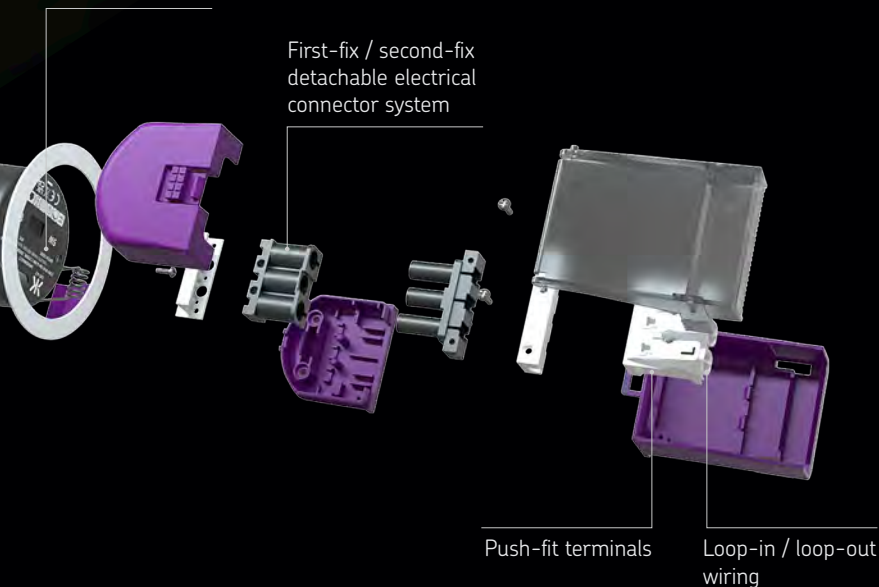

FIRE-RATED



TIMBER JOIST



30/60/90 mins



WEB JOIST



30 mins



I-JOIST*



30 mins

*Knightsbridge tests against staircraft style i-joists only



Warm white

Cool white

Daylight



5W



2700K



3000K



4000K



6000K

8W



2700K



3000K



4000K



6000K



Residential

Commercial

Hospitality

Light engine can be taken off site until second-fix stage in order to avoid potential damage when painting and decorating



Push-fit terminals with loop-in / loop-out for easy installations



SpektoLED® INTEGRATED LED CCT & WATTAGE ADJUSTABLE DOWNLIGHT

- 230V AC direct to fixture with loop-in / loop-out, first and second-fix connectors
- Selectable 5W (up to 465lm) and 8W (up to 795lm) outputs (to regulate maximum light output) for varying illumination requirements
- Selectable 2700K, 3000K, 4000K, 6000K CCT's
- Complies with the latest energy efficiency standards

Construction: Pressed steel

Driver: Integral

Lamp type: LED

Beam angle: 60°

Cut-out Ø	Overall Ø	Minimum Void (mm)
70	87	42

Code	Wattage	Colour	CCT	Lumens
SPEK2W4CCT	5W / 8W	CCT Adjustable	2700K / 3000K / 4000K / 6000K	795lm (Max.) NEW

SpektoLED BEZELS

Code	Finish	Code
SPEKBC	Brushed Chrome	NEW
SPEKPC	Polished Chrome	NEW
SPEKW	White	NEW
SPEKMB	Matt Black	NEW
SPEKB	Brass	NEW

230V 50Hz	IP65		 LAMP INCLUDED
5 YEAR WARRANTY		IC* RATED	 ACOUSTIC RATED

*With mineral wool style insulation only, please see page 224 and product instructions for more information



FIRE-RATED DOWNLIGHTS

EASY-INSTALL

Loop-in/loop-out with push-fit terminals

FIRE-RATED



TIMBER JOIST



30/60/90 mins

CCT ADJUSTABLE DOWNLIGHT RW6CCT

Switch between 3 colour temperatures at the flick of a switch or push dimmer (memory function included)



WARM WHITE
3000K

Also available on:
RW6WW, RW6DTW

COOL WHITE
4000K

Also available on:
RW6CW

DAYLIGHT
6000K



SMARTHOME

Control lighting via the SmartKnight app, with no hub required.



FOR FULL LIST OF SMART
FEATURES, SEE PAGE 210

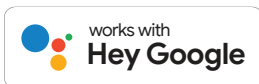

Amazon, Alexa and all related logos are trademarks of Amazon.com, Inc. or its affiliates.

Google is a trademark of Google LLC.



6W INTEGRATED LED DOWNLIGHTS

Construction: Aluminium & polycarbonate

Driver: Integral

Lamp type: LED

Beam angle: 40°

Cut-out Ø	Overall Ø	Minimum Void	(mm)
72	85	120	

Code	Wattage	Colour	CCT	Lumens
RW6WW	6W	Warm White	3000K	595lm
RW6CW	6W	Cool White	4000K	690lm
RW6DTW	6W	Dim-to-Warm	2200K to 3000K	435lm (at 3000K)
RW6CCT	6W	CCT Adjustable	3000K / 4000K / 5000K	595lm / 695lm / 665lm

SMART DOWNLIGHTS

- For more information on the Knightsbridge Smart Home range, visit pages 202 - 215

Code	Wattage	Colour	Lumens
RW6KW	6W	CCT Adjustable ● ● ● ● ● ● ● ● ● ●	510lm (at 3000K)
RW6KRGBW	6W	RGBW + CCT Adjustable ● ● ● ● ● ● ● ● ● ●	440lm (at 3000K)



*With mineral wool style insulation only, please see page 224 and product instructions for more information

BEZELS

Construction: Pressed steel

Code	Finish
RW6BC	Brushed Chrome
RW6C	Chrome
RW6MB	Matt Black
RW6MW	Matt White



FLAT BEZELS

Construction: Pressed steel

Code	Finish
RW6FBC	Brushed Chrome
RW6FBR	Brass
RW6FC	Chrome
RW6FMB	Matt Black
RW6FMW	Matt White



*5-year warranty applies to non-smart products only, RW6KRGBW and RW6KW come with a 2-year warranty



FIRE-RATED DOWNLIGHTS

- IC rated for use under mineral wool insulation (when installed in conjunction with IC* cage)
- 3 easy-fit coloured bezels are available in chrome, brushed chrome or white finish (not included)
- Complete with IC rated dimmable driver

VALKNIGHT 8W INTEGRATED LED DOWNLIGHTS

Construction: Die-cast aluminium
Driver: Included
Lamp type: LED
Beam angle: 40°



230V 50Hz IP65 LAMP INCLUDED 5 YEAR WARRANTY IC RATED

Bezel not included

Cut-out Ø	Overall Ø	Minimum Void	Recessed Depth	(mm)
65	80	100	50	

Code	Wattage	Colour	CCT	Lumens
VFRIC8WW	8W	Warm White	3000K	580lm
VFRIC8CW	8W	Cool White	4000K	640lm

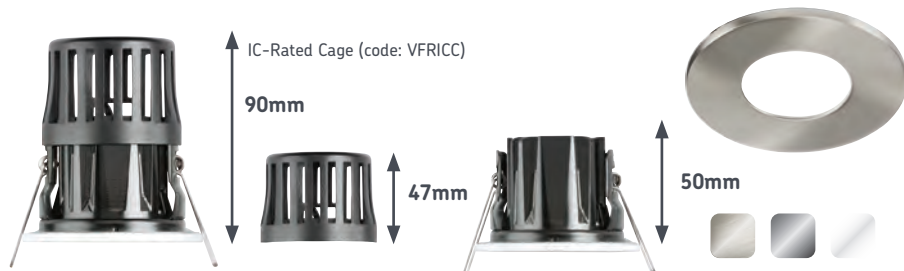

BEZELS / IC-RATED CAGE

Construction: Die-cast aluminium
IC Rated Cage Construction: Polycarbonate

Code	Model
VFRICBEZC	Chrome
VFRICBEZCBR	Brushed Chrome

Code	Model
VFRICBEZW	White
VFRICC	IC-Rated Cage

*With mineral wool style insulation only, please see page 224 and product instructions for more information. IC rated with cage only

For Hole Converters, see page 222

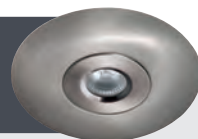

FIRE-RATED

TIMBER JOIST
 30/60/90 mins

I- JOIST
 30 mins

*Knightsbridge tests against staircraft style i-joists only

VALKNIGHT 8W INTEGRATED LED TILT DOWNLIGHTS

Construction: Die-cast aluminium
Driver: Included
Lamp type: LED
Beam angle: 40°
Tilt: 25°

(Bezel not included)



Cut-out Ø	Overall Ø	Minimum Void	Recessed Depth	(mm)
75	88	100	55	

Code	Wattage	Colour	CCT	Lumens
VFRIC8TWW	8W	Warm White	3000K	580lm
VFRIC8TCW	8W	Cool White	4000K	640lm

TILT BEZELS / IC-RATED CAGE

Construction: Aluminium
IC rated cage construction: Polycarbonate

Code	Model
VFRICTBEZC	Chrome
VFRICTBEZCBR	Brushed Chrome
VFRICTBEZW	White
VFRICTC	IC-Rated Cage

FIRE-RATED



*Knightsbridge tests against staircraft style i-joists only

IC-Rated Cage (Code: VFRICTC)



EMERGENCY LIGHTING ACCESSORIES

- Compatible with tilt and standard Valknight models
- Downlight not included



Code	Model
VFR7EM	Emergency Conversion Kit
ICEMC	Emergency Conversion Connector Leads

*With mineral wool style insulation only, please see page 224 and product instructions for more information. IC rated with cage only



FIRE-RATED DOWNLIGHTS

PROKNIGHT 8W INTEGRATED LED DOWNLIGHTS

- Lightweight, low profile model incorporating an aluminium heat sink
- Complete with driver and loop in / loop out screwless terminal block
- Low energy downlights offering a true 'halogen feel'



Construction: Die-cast aluminium

Driver: Included

Lamp type: CoB LED

Beam angle: 38°



Cut-out Ø	Overall Ø	Minimum Void	Recessed Depth	(mm)
64	80	97	41	

Code	Wattage	Colour	CCT	Lumens
VFR8WW	8W	Warm White	2700K	615lm
VFR8CW	8W	Cool White	4000K	690lm

BEZELS

Construction: Die-cast aluminium

Height	Overall Ø	(mm)
3.8	80	

Code	Finish
VFR8BEZBL	Black
VFR8BEZBR	Brass
VFR8BEZCBR	Brushed Chrome
VFR8BEZCH	Chrome
VFR8BEZMW	Matt White



For Hole Converters, see page 222

FIRE-RATED

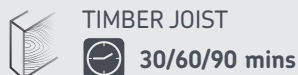

*Kingsbridge tests against staircraft style i-joists only

FIRE-RATED DOWNLIGHTS

PROKNIGHT 8W INTEGRATED LED TILT DOWNLIGHTS

- Exclusive range of interchangeable bezels also available
- Up to 35,000 hours average lamp life
- Supplied without bezel



Construction: Die-cast aluminium & steel

Driver: Included

Lamp type: CoB LED

Beam angle: 38°

Tilt: 25°



Cut-out Ø	Overall Ø	Minimum Void	Recessed Depth (mm)
74	88	97	

Code	Wattage	Colour	CCT	Lumens
VFR8TWW	8W	Warm White	2700K	615lm
VFR8TCW	8W	Cool White	4000K	690lm

TILT BEZELS

Construction: Die-cast aluminium

Height	Overall Ø	(mm)
3.8	88	

Code	Finish
VFR8TBEZBL	Black
VFR8TBEZBR	Brass
VFR8TBEZCBR	Brushed Chrome
VFR8TBEZCH	Chrome
VFR8TBEZMW	Matt White



EMERGENCY KIT

Code	Finish
VFR7EM	White



FIRE-RATED



*Knightsbridge tests against staircraft style i-joists only



FIRE-RATED DOWNLIGHTS

- Low energy downlights offering a true 'halogen feel'
- Supplied with a pre-wired 'plug & play' dimmable LED driver
- An extended warranty of up to 7 years is available on request*
- * Conditions apply. See website for details

FIREKNIGHT 7W INTEGRATED LED DOWNLIGHTS

- Optional round and square bezels available
- Supplied with white bezel as standard

Construction: Die-cast aluminium
Beam angle: 38°



Cut-out Ø	Overall Ø	Minimum Void	Recessed Depth	(mm)
65	80	110	60	

Code	Wattage	Colour	CCT	Lumens
VFRCOBWW	7W	Warm White	3000K	545lm
VFRCOBCW	7W	Cool White	4000K	580lm

ROUND & SQUARE BEZELS

Code	Model	Finish
VFRBEZAB	Round	Antique Brass
VFRBEZBK	Round	Black
VFRBEZBR	Round	Brass
VFRBEZCBR	Round	Brushed Chrome
VFRBEZCH	Round	Chrome
VFRBEZGM	Round	Gunmetal
VFRBEZW	Round	White
VFRSBEZBK	Square	Black
VFRSBEZCBR	Square	Brushed Chrome
VFRSBEZCH	Square	Chrome
VFRSBEZW	Square	White

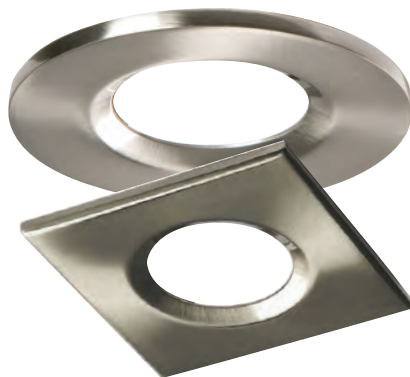

FIRE-RATED



TIMBER JOIST



30/60/90 mins



I- JOIST



30 mins

*Knightsbridge tests against staircraft style i-joists only

FIREKNIGHT 7W INTEGRATED LED TILT DOWNLIGHTS

- Please note, bezels are not interchangeable on FireKnight tilt downlights

Construction: Die-cast aluminium

Beam angle: 38°

Tilt: 25°



Cut-out Ø	Overall Ø	Minimum Void	Recessed Depth	(mm)
74	88	106	56	

Code	Wattage	Bezel	Colour	CCT	Lumens
VFRC0BWW1	7W	White	Warm White	3000K	545lm
VFRC0BWW2	7W	Chrome	Warm White	3000K	545lm
VFRC0BWW3	7W	Brushed Chrome	Warm White	3000K	545lm
VFRC0BCW1	7W	White	Cool White	4000K	580lm
VFRC0BCW2	7W	Chrome	Cool White	4000K	580lm
VFRC0BCW3	7W	Brushed Chrome	Cool White	4000K	580lm

HOLE CONVERTERS

- Enables fixed downlights to be used in 65mm-130mm cut-outs
- Lamps not included with hole converters

Construction: Pressed steel

Height	Cut-out Ø	Overall Ø	(mm)
6.5	65 - 130	180	

Code	Finish
VFRCBC	Brushed Chrome
VFRCC	Chrome
VFRCW	White



Suitable for fixed versions only

EMERGENCY KIT

Code	Finish
VFR7EM	White



FIRE-RATED



*Knightsbridge tests against staircraft style i-joists only



DOMESTIC INTERIOR CEILING & WALL LIGHTS

Decorative ceiling, track and wall lighting, designed to enhance the look and feel of living spaces

Ceiling Lights

Track Lighting	248 - 249
Track Pendants	250
Tracklight Kits	251
Track Accessories	253
Spotlights	254 - 259

Wall Lights

Up/Down Gypsum Plaster Wall Lights	260
Recessed Interior Gypsum Plaster Wall Lights	261
Up/Down Wall Lights	262
LED Recessed Wall Lights	263



TRACK LIGHTING

TRKSP1

Construction: Aluminium

Lamp type: GU10 LED

Height	Width	Projection	Length (mm)
142	32	128	50



Code	Finish
------	--------

TRKSP1ABC Brushed Chrome

TRKSP1ABK Black

TRKSP1AW White



TRKSP2

Construction: Aluminium

Lamp type: GU10 LED

Height	Overall Ø	Projection	Length (mm)
145	34	131	50



Code	Finish
------	--------

TRKSP2ABC Brushed Chrome

TRKSP2ABK Black

TRKSP2AW White



TRKSP3

Construction: Aluminium

Lamp type: GU10 LED

Height	Overall Ø	Projection	Length (mm)
144	35	130	50



Code	Finish
------	--------

TRKSP3ABC Brushed Chrome

TRKSP3ABK Black

TRKSP3AW White

GU10 LED LAMPS
PAGE 443
FOR TRACKLIGHT KITS
PAGE 251





TRKSP4

Construction: Aluminium

Lamp type: GU10 LED

Height	Overall Ø	Projection	Length (mm)
170	58	155	105



Code	Finish
TRKSP4ABC	Brushed Chrome
TRKSP4ABK	Black
TRKSP4AW	White



TRKSP5

Construction: Aluminium

Lamp type: GU10 LED

Height	Overall Ø	Projection	Length (mm)
175	56	160	75



Code	Finish
TRKSP5ABC	Brushed Chrome
TRKSP5ABK	Black
TRKSP5AW	White



TRKSP6

Construction: Aluminium & glass

Lamp type: G9 LED

Height	Overall Ø	Projection	Length (mm)
179	60	164	82



Code	Finish
TRKSP6ABC	Brushed Chrome
TRKSP6ABK	Black
TRKSP6AW	White



TRKSP8

Construction: Aluminium

Lamp type: GU10 LED

Height	Overall Ø	Projection	Length (mm)
176	56	163	81



Code	Finish
TRKSP8ABC	Brushed Chrome
TRKSP8ABK	Black
TRKSP8AW	White





TRACK PENDANTS

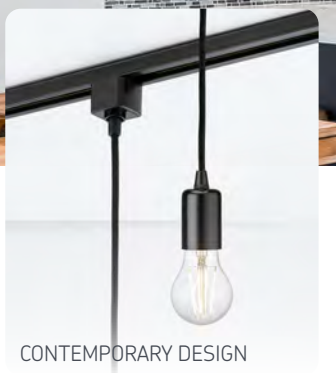

CONTEMPORARY DESIGN

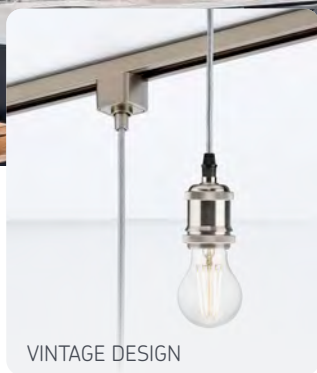

VINTAGE DESIGN

These pendants are ideal for bringing a unique look and design to any installation, can be customised by adjusting the height and position of each fitting.

- 1.8m drop (length can be adjusted if required)
- Pre-wired to TRKxx adaptor
- Compatible with TRKxx series

Construction: Die-cast aluminium

Lamp type: E27



Length	Overall Height	Diameter	(mm)
1800	1907.5	40	
Code	Design	Finish	
TRK8270BC	Contemporary	Brushed Chrome	NEW
TRK8270BK	Contemporary	Black	NEW
TRK8270W	Contemporary	White	NEW
TRK8271BC	Vintage	Brushed Chrome	NEW
TRK8271BK	Vintage	Black	NEW
TRK8271W	Vintage	White	NEW

*lamps not included



TRACKLIGHT KITS

Everything you need in one convenient bundle, supplied with:

- 1 x 1-metre circuit track
- 1 x live and dead-end accessories
- 3 x TRKSP tracklights
- 350° rotation and 80° tilt



Construction: Aluminium
Lamp type: GU10 LED



TRKIT4

Width	Projection	Length	(mm)
57	172	1000	

Code	Finish	
TRKIT4BC	Brushed Chrome	NEW
TRKIT4BK	Black	NEW
TRKIT4W	White	NEW



TRKIT8A

Width	Projection	Length	(mm)
56	180	1000	

Code	Finish	
TRKIT8ABC	Brushed Chrome	NEW
TRKIT8ABK	Black	NEW
TRKIT8AW	White	NEW

GU10 LED
LAMPS
PAGE 443





KEEP UP TO DATE WITH NEW PRODUCTS, SPECIAL OFFERS, AND MORE



 **Knightsbridge**



@KnightsbridgeML



@Knightsbridgemla



@Knightsbridge



@Knightsbridgemla



To indicate preferred finish, replace xx on code with S (satin nickel), BK (black), or W (white)

230V 16A SINGLE CIRCUIT TRACK

Code	Length
TRK1MAxx	1m
TRK2MAxx	2m
TRK3MAxx	3m

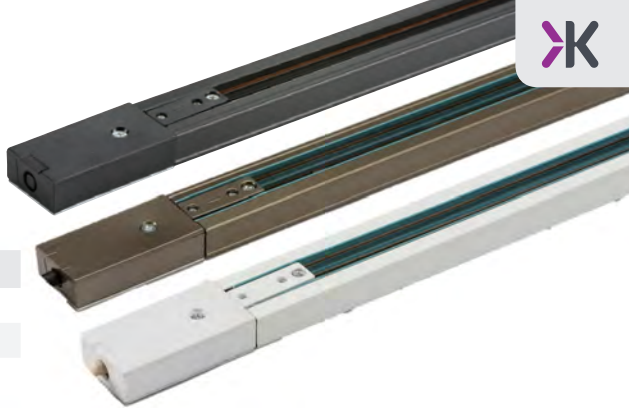

TRACK ACCESSORIES

Code	Length
TRKC1xx	Track Connector
TRKDE1xx	Dead End Cap
TRKFC1xx	Flexible Connector
TRKLC1xx	Inline Connector
TRKPF1xx	Power Feed
TRKRA1xx	Right Angle Connector
TRKT1xx	T-Connector
TRKX1xx	X-Connector

TRKCS



TRKDES



TRKRAS



TRKTS



TRKFCS



TRKLC5



TRKXS



TRACK ADAPTOR

Code	Length
TRKAD1xx	Track Adaptor





GU10 spotlights in a variety of finishes, with adjustable directional heads. Suitable for commercial and domestic use.

Construction: Pressed steel
Lamp type: GU10 LED

SINGLE SPOTLIGHTS

- Suitable for ceiling and wall mounting



Base Ø	Projection	(mm)
80	125	

Code	Finish	
CSP1AB	Antique Brass	NEW
CSP1BC	Brushed Chrome	NEW
CSP1MB	Matt Black	NEW

TRIPLE SPOTLIGHTS



Base Ø	Projection	(mm)
150	125	

Code	Finish	
CSP2AB	Antique Brass	NEW
CSP2BC	Brushed Chrome	NEW
CSP2MB	Matt Black	NEW

QUAD SPOTLIGHTS



Base	Projection	(mm)
160	125	
Code	Finish	
CSP3AB	Antique Brass	NEW
CSP3BC	Brushed Chrome	NEW
CSP3MB	Matt Black	NEW



QUAD BAR SPOTLIGHTS

Base Width	Projection	(mm)
520	125	
Code	Finish	
CSP4AB	Antique Brass	NEW
CSP4BC	Brushed Chrome	NEW
CSP4MB	Matt Black	NEW





NSPG SPOTLIGHTS

Construction: Steel
Lamp type: GU10 LED

SINGLE SPOTLIGHT

- Suitable for wall or ceiling mounting



Base Ø	Projection	(mm)
80	110	
Code	Finish	
NSPGU1BC	Brushed Chrome	
NSPGU1C	Chrome	
NSPGU1W	White	



DOUBLE SPOTLIGHT

Base Ø	Width	Projection	(mm)
90	360	135	

Code	Finish	
NSPGU2BC	Brushed Chrome	
NSPGU2C	Chrome	





TRIPLE SPOTLIGHT

Base Ø	Projection	(mm)
200	110	
Code	Finish	
NSPGU3BC	Brushed Chrome	
NSPGU3C	Chrome	



QUAD SPOTLIGHT

Base Ø	Width	Projection	(mm)
90	765	135	

Code	Finish
NSPGU4BC	Brushed Chrome
NSPGU4C	Chrome





GU10 LED
LAMPS
PAGE 443

NSPG SPOTLIGHTS

Construction: Steel
Lamp type: GU10 LED



SINGLE SPOTLIGHT

- Can be wall mounted

Width	Projection	Length	(mm)
80	186	120	

Code	Finish
NSP1C	Chrome



TRIPLE SPOTLIGHT

Width	Projection	Length	(mm)
80	190	500	

Code	Finish
NSP3C	Chrome



QUAD SPOTLIGHT

Width	Projection	Length	(mm)
80	190	640	

Code	Finish
NSP4C	Chrome





PWL1



PWL2



PWL3



PWL4

UP/DOWN GYPSUM PLASTER WALL LIGHTS (PAINTABLE)

Modern curved up/down wall lights with a natural gypsum plaster construction.

- Supplied in a stylish white finish, which can be painted using a good quality emulsion paint, enabling it to blend into surrounding walls seamlessly
- Can used in isolation or in a row of multiple fittings to create ambient lighting effects – ideal for corridors and hallways

Construction: Gypsum (plaster)

Lamp type: G9 LED

230V
50Hz

IP20



Code	Model	Height	Width	Projection	
PWL1	Curved	180mm	110mm	70mm	NEW
PWL2	Cuboid	180mm	110mm	70mm	NEW
PWL3	Curved	120mm	200mm	150mm	NEW
PWL4	Curved	90mm	180mm	100mm	NEW



RECESSED INTERIOR GYPSUM PLASTER WALL LIGHTS

Trimless, flush, recessed wall lights, with discreet lighting output.

- Supplied in a stylish white finish, which can be painted using a good quality emulsion paint, enabling it to blend into surrounding walls seamlessly
- Can used in isolation or in a row of multiple fittings to create ambient lighting effects – ideal for corridors and hallways

Construction: Gypsum (plaster)

Lamp type: GU10 LED



Code	Model	Height	Width	Recessed Depth	Cut-out	
PWRCR	Rectangular	350mm	100mm	73mm	100 x 350mm	NEW
PWRCC	Circular	250mm	210mm	78mm	210 x 250mm	NEW

NH0183BD



NH0184SQ



UP/DOWN WALL LIGHTS

- Lamp colours can be changed to add colour and ambience as required

Construction: Stainless steel

Lamp type: GU10 LED

230V
50Hz

IP20



Code	Model	Height	Overall Ø	Width	Projection	Base
NH0183BD	Tubular	161mm	60mm	-	85mm	Ø 78mm
NH0184SQ	Square	161mm	-	60mm	99mm	W: 60mm x H: 60mm



GU10 LED
LAMPS
PAGE 443

LED PLINTH LIGHTS

- Ideal for placement in staircases
- Fits standard UK steel back boxes and dry lining boxes
- Minimum mounting depth: 25mm
- Cool white 4000K

Construction: Stainless steel

Lamp type: LED

Height	Width	Projection	(mm)
87.5	87.5	4.3	

Code	Finish
SFPLBC	Brushed Chrome
SFPLMW	Matt White



LED RECESSED WALL LIGHTING

Recessed LED guide light complete with integral driver. Ideal for stairways and corridors.

- Brushed chrome finish
- Manufactured to fit a standard 47mm recessed back box (not supplied)
- Low level guide lighting creates a soft ambient glow
- For indoor use only

Construction: Stainless steel

Lamp type: LED

Height	Width	Projection	(mm)
80	80	5	

Code	Wattage	Colour	Lumens
NH023B	1W	Blue	-
NH023W	1W	White	80lm
NH025W	1W	White (4 Squares)	80lm





DOMESTIC INTERIOR BATHROOM

Stylish mirrors and lighting that complement any modern bathroom. This range includes shaver lights with USB ports

G9 Bathroom Wall Lights and Spotlights	266 - 269
GU10 Bathroom Spotlights	270 - 271
LED Wall and Mirror/Cabinet Lights	272 - 273
LED Shaver Lights with Shaver Sockets	274 - 275
LED Bathroom Mirrors	276 - 279
CCT Adjustable LED Bulkheads	280 - 281
Bathroom Downlights and Shelf Lighting	282



BA01S1MB



BA01S1C



Our new range of G9 and GU10 decorative spotlights, ideal for domestic and commercial bathrooms.

G9 BATHROOM WALL LIGHTS WITH ROUND FROSTED GLASS

Construction: Pressed steel

Lamp type: G9

230V
50Hz

IP44



Code	Model	Finish	Dimensions	Base	
BA01S1C	Single Spotlight	Chrome	Ø: 100 H: 177 P: 124mm	Ø: 90 D: 26mm	NEW
BA01S1MB	Single Spotlight	Matt Black	Ø: 100 H: 177 P: 124mm	Ø: 90 D: 26mm	NEW

G9 BATHROOM SPOTLIGHTS WITH ROUND FROSTED GLASS

Construction: Pressed steel

Lamp type: G9

Tilt/Rotation: 90°/350°

230V
50Hz

IP44



BA01P3C



BA01P3MB



BA01B3MB



BA01B3C

Code	Model	Finish	Dimensions	Base	
BA01P3C	Triple Spotlight	Chrome	Ø: 220 P: 187mm	Ø: 150 D: 25mm	NEW
BA01P3MB	Triple Spotlight	Matt Black	Ø: 220 P: 187mm	Ø: 150 D: 25mm	NEW
BA01B3C	Triple Bar Spotlight	Chrome	Ø: 100 W: 430 P: 187mm	W: 400 H: 50 D: 25mm	NEW
BA01B3MB	Triple Bar Spotlight	Matt Black	Ø: 100 W: 430 P: 187mm	W: 400 H: 50 D: 25mm	NEW

MATCH THE FINISH!

Other finishes also available



page 101



page 182



page 274



BA02S1C



BA02S1MB

G9 BATHROOM SPOTLIGHTS WITH FROSTED GLASS

Construction: Die-cast aluminium

Lamp type: G9

Tilt/Rotation: 90°/350°

230V
50Hz

IP44



BA02P3MB

Code	Model	Finish	Dimensions	Base	
BA02S1C	Single Spotlight	Chrome	Ø: 55 H: 100 P: 123mm	Ø: 90 D: 26mm	NEW
BA02S1MB	Single Spotlight	Matt Black	Ø: 55 H: 100 P: 123mm	Ø: 90 D: 26mm	NEW
BA02P3C	Triple Spotlight	Chrome	Ø: 246 P: 122mm	Ø: 150 D: 25mm	NEW
BA02P3MB	Triple Spotlight	Matt Black	Ø: 246 P: 122mm	Ø: 150 D: 25mm	NEW

G9 BATHROOM SPOTLIGHTS WITH FROSTED GLASS

Construction: Die-cast aluminium

Lamp type: G9

Tilt/Rotation: 90°/350°



BA02B3MB



BA02B3C

Code	Model	Finish	Dimensions	Base	
BA02B3C	Triple Bar Spotlight	Chrome	Ø: 55 W: 86 P: 125mm	W: 400 H: 50 D: 25mm	NEW
BA02B3MB	Triple Bar Spotlight	Matt Black	Ø: 55 W: 86 P: 125mm	W: 400 H: 50 D: 25mm	NEW



BA03S1C

BA03S1MB



GU10 BATHROOM SPOTLIGHTS

Construction: Die-cast aluminium

Lamp type: GU10

Tilt/Rotation: 90°/350°

230V
50Hz

IP44



Code	Model	Finish	Dimensions	Base	
BA03S1C	Single Spotlight	Chrome	Ø: 55 H: 100 P: 123mm	Ø: 90 D: 26mm	NEW
BA03S1MB	Single Spotlight	Matt Black	Ø: 55 H: 100 P: 123mm	Ø: 90 D: 26mm	NEW
BA03S1MW	Single Spotlight	Matt White	Ø: 55 H: 100 P: 123mm	Ø: 90 D: 26mm	NEW



GU10 BATHROOM SPOTLIGHTS

Construction: Die-cast aluminium

Lamp type: GU10

Tilt/Rotation: 90°/350°



BA03B3C



Code	Model	Finish	Dimensions	Base	
BA03P3C	Triple Spotlight	Chrome	Ø: 246 P: 122mm	Ø: 150 D: 25mm	NEW
BA03P3MB	Triple Spotlight	Matt Black	Ø: 246 P: 122mm	Ø: 150 D: 25mm	NEW
BA03P3MW	Triple Spotlight	Matt White	Ø: 246 P: 122mm	Ø: 150 D: 25mm	NEW
BA03B3C	Triple Bar Spotlight	Chrome	Ø: 55 W: 86 P: 125mm	W: 400 H: 50 D: 25mm	NEW
BA03B3MB	Triple Bar Spotlight	Matt Black	Ø: 55 W: 86 P: 125mm	W: 400 H: 50 D: 25mm	NEW
BA03B3MW	Triple Bar Spotlight	Matt White	Ø: 55 W: 86 P: 125mm	W: 400 H: 50 D: 25mm	NEW

BA03P3W



BA03P3C



BA03P3MB





LED WALL LIGHTS

Construction:
Aluminium & Polycarbonate (BWLED4)
Polycarbonate (BWLED9)

Driver: Integral

Lamp type: LED



230V
50Hz

IP44



3
YEAR
WARRANTY



Width	Height	Projection	(mm)
600	52	64 (BWLED4)	69 (BWLED9)

Code	Model	Wattage	Finish	Colour	CCT	Lumens
BWLED4	With Pull Cord Switch	15W	Chrome	Warm White	3000K	1300lm
BWLED9	With Dual Colour End Caps	15W	White	Warm White	3000K	1360lm



Bathroom luminaire installations must comply with legislation. This has recently been updated and is now Section 701 of BS7671 : 2018 (Wiring Regulations 18th Edition)

Zone 0 is inside the bath or shower itself. Any fitting used in this zone must be IP67 low voltage (max 12V).

Zone 1 is the area above the bath to a height of 2.25m from the floor. In this zone a minimum rating of IP44 is required.

Zone 2 is an area stretching 0.6m outside the perimeter of the bath and to a height of 2.25m from the floor. In this zone an IP rating of at least IP44 is required (except for shaver sockets located where direct spray is unlikely). In addition, it is good practice to consider the area around a wash basin (within a 60cm radius of any tap) as Zone 2.

Outside zones is anywhere outside zones 0, 1 and 2 (subject to specific limits) and where no water jet is likely to be used. No IP rating is required.

In addition to the above, if there is a likelihood of water jets being used for cleaning purposes in zones 1, 2 and "Outside Zones" a fitting rated a minimum IP65 must be used.

A 30mA residual current device (RCD) must also be used to protect all circuits supplying the location. Full details can be found in the latest copy of IEE wiring regulations.

LED WALL-MOUNTED MIRROR / CABINET LIGHT

Construction: Aluminium & polycarbonate

Driver: Integral

Lamp type: LED



Width	Height	Projection	(mm)
400	41	121	

Code	Wattage	Colour	CCT	Lumens
BWLED1	8W	Warm White	3000K	650lm



LED WALL-MOUNTED MIRROR / CABINET LIGHT

Construction: Aluminium & polycarbonate

Driver: Integral

Lamp type: LED



Width	Height	Projection	(mm)
400	44	134	

Code	Wattage	Finish	Colour	CCT	Lumens
BWLED2	8W	Polished Chrome Effect	Warm White	3000K	650lm



LED OVER MIRROR / CABINET LIGHT

- Modern and lightweight design, ideal for above a mirror or cabinet within zones 2 and 3 in the bathroom
- Robust, polycarbonate material

Construction: Polycarbonate

Driver: Integral

Lamp type: LED



Width	Height	Projection	(mm)
400	53	116	

Code	Wattage	Finish	Colour	CCT	Lumens
BWLED10	6W	Chrome	Warm White	3000K	610lm





LED SHAVER LIGHT WITH DUAL USB CHARGER

Construction: Polycarbonate

Driver: Included

Lamp type: LED



- 230V
50Hz
- IP20
- IP21
SHAVER
SOCKET
- LAMP INCLUDED

Width	Height	Projection	(mm)
492	60	70	

Code	Wattage	Finish	Colour	CCT	Lumens
SL6USBW	6W	White	Warm White	3000K	620lm NEW
SL6USBC	6W	Chrome	Warm White	3000K	620lm NEW
SL6USBMB	6W	Matt Black	Warm White	3000K	620lm NEW



SL6USBW



SL6USBC

LED SHAVER LIGHT WITH DUAL VOLTAGE SHAVER SOCKET

Construction: Polycarbonate

Driver: Included

Lamp type: LED



Width	Height	Projection	(mm)
494	60	70	

Code	Wattage	Finish	Colour	CCT	Lumens
SLIGHT2	6W	White	Warm White	3000K	450lm

230V
50Hz

IP20

IP21
SHAVER
SOCKET



LED SHAVER LIGHT WITH 230V SHAVER SOCKET AND USB PORT

- Shaver socket and 5V DC 2A output
- USB port works independently from the light
- Pull cord switch fitted for independent light switching
- Maximum 2kg weight on glass shelf

Construction: Aluminium & polycarbonate

Driver: Included

Lamp type: LED



Width	Height	Projection	(mm)
600	75	120	

Code	Wattage	Finish	Colour	CCT	Lumens
SLULED	11W	Chrome	Warm White	3000K	765lm



230V
50Hz

IP44



3
YEAR
WARRANTY





VANITY MIRROR

Construction: Pressed steel

Driver: Included

Lamp type: LED

Width	Projection	Base Ø	Overall Ø (mm)
333	270	110	200

Code	Wattage	Finish	Colour	CCT	Lumens
VML1	3W	Chrome	Warm White	3000K	60lm

230V
50Hz

IP44



3
YEAR
WARRANTY



LED BATHROOM MIRROR WITH DUAL VOLTAGE SHAVER SOCKET

- Complete with pull cord switch

Construction: Pressed steel

Driver: Included

Lamp type: LED

Width	Height	Projection	Base	(mm)
390	500	60	W: 350 H: 480	

Code	Wattage	Colour	CCT	Lumens
MLRCTM2	10W	Cool White	4000K	165lm NEW



LED COLOUR CHANGING MIRROR

- Edge-lit, multicoloured LEDs enhance the ambience or mood and look perfect over a vanity unit or basin
- Supplied with remote control with memory function

Construction: Aluminium & glass

Driver: Included

Lamp type: LED

Width	Height	Projection	(mm)
500	700	40	

Code	Wattage	Colour
RCTRGB	18W	RGB

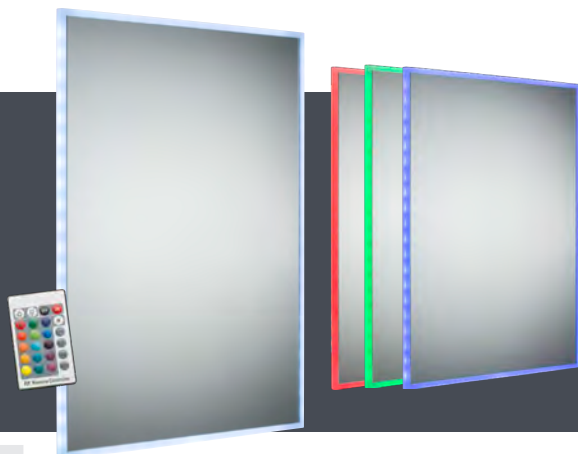



BACK-LIT LED BATHROOM MIRROR WITH DEMISTER, SHAVER SOCKET, AND MOTION SENSOR

- Contemporary design, featuring 360° illumination
- Pressed steel base with high quality glass mirror
- Motion sensor on/off switch
- Dual voltage 115V / 230V shaver socket outlet with independent switch control
- Built-in anti-fog 12W demister pad
- Fixings included

Construction: Pressed steel

Driver: Included

Lamp type: LED



Width	Height	Projection	Base	(mm)
450	600	65	W: 355 H: 500	
Code	Wattage	Colour	CCT	Lumens
MLR6045SD	19W	Cool White	4000K	1150lm NEW



LED BATHROOM MIRROR WITH DEMISTER, SHAVER SOCKET, AND MOTION SENSOR

- Pressed steel base with high quality glass mirror
- Motion sensor on/off switch
- Dual voltage 115V / 230V shaver socket outlet with independent switch control
- Built-in anti-fog 16W demister pad
- Fixings included

Construction: Pressed steel

Driver: Included

Lamp type: LED



Width	Height	Projection	Base	(mm)
450	600	55	W: 410 H: 565	

Code	Wattage	Colour	CCT	Lumens
MLC6045SD	14W	Cool White	4000K	110lm NEW



LED CIRCULAR BATHROOM MIRROR

- Featuring mini circular LED border design, providing evenly spread illumination
- Pressed steel base with high quality glass mirror
- Motion sensor on/off switch
- Fixings included

Construction: Pressed steel

Driver: Included

Lamp type: LED



Overall Ø	Projection	Base	(mm)	230V 50Hz	IP44	LAMP INCLUDED	
500	50	D: 435					

Code	Wattage	Colour	CCT	Lumens
ML500	14W	Cool White	4000K	35lm NEW



CCT ADJUSTABLE LED BULKHEAD

This versatile IP65 LED bulkhead boasts LED colour changing technology enabling the installer / end-user to adjust the colour temperature via a switch on the gear tray.

- Time saving and user-friendly installation via hinged gear tray and push-fit terminal block

- Specialised polycarbonate diffuser ensures high lumen levels with smooth uninterrupted light
- Suitable for domestic and commercial applications, wall or ceiling mounted
- Supplied with black or chrome bezel

Construction: Polycarbonate

Driver: Included

Lamp type: LED



14W CCT ADJUSTABLE LED BULKHEAD

CCT adjustable to 3000K, 1130lm / 4000K, 1260lm / 5700K, 1210lm

Overall Ø	Projection (mm)
315	74

Code	Wattage	Model	Colour	CCT	
BT14ACTB	14W	Standard	Black	3000/4000/5700K	NEW
BT14ACTCH	14W	Standard	Chrome	3000/4000/5700K	NEW

9W CCT ADJUSTABLE LED BULKHEAD

CCT adjustable to 3000K, 730lm / 4000K, 810lm / 5700K, 780lm

Overall Ø	Projection (mm)
256	74

Code	Wattage	Model	Colour	CCT	
BT9ACTB	9W	Standard	Black	3000/4000/5700K	NEW
BT9ACTCH	9W	Standard	Chrome	3000/4000/5700K	NEW





BATHROOM DOWNLIGHTS

Construction: Die-cast aluminium

Driver: Not required



- 230V IP65 GU10 range of recessed bathroom downlights
- Manufactured from die-cast aluminium
- Supplied complete with pre-wired GU10 230V lampholder
- Designed for use in bathrooms and shower cubicles etc.
- LED compatible (35W max.)

Bezel	Minimum Void	Recessed Depth	Cut-out	(mm)
84	140	90	64	

Code	Finish
RDSHC	Chrome
RDSHCBR	Brushed Chrome
RDSHW	White



BATHROOM WALL / SHELF LIGHTS

- Comes with three interchangeable chrome-effect heads
- Perfect for creating ambient effects in bathrooms

Construction: Stainless steel & polycarbonate

Driver: Included

Lamp type: LED

Recessed Depth	Overall Ø	Cut-out	(mm)
48	38	32	

Code	Wattage	Finish	Colour	CCT	Lumens
LEDM06B	0.6W	Brushed Nickel	Blue	-	-
LEDM06W	0.6W	Brushed Nickel	White	6000K	50lm

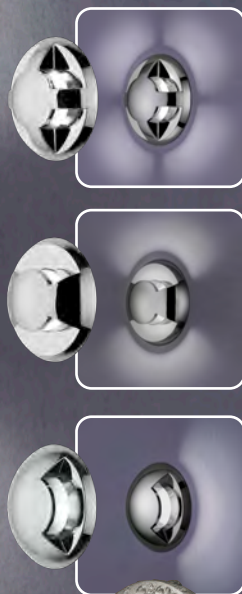

THE PERFECT FIT FOR BATHROOMS

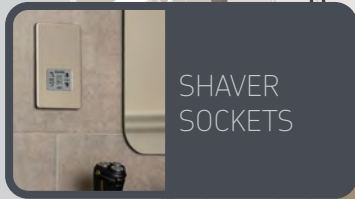



DOMESTIC INTERIOR UNDER CABINET LIGHTING

Under cabinet lighting creates the perfect glow on kitchen worktops, providing discreet but effective illumination

CCT Adjustable LED Linkable Striplights	286 - 287
LED Linkable Striplights	288
LED Linkable Striplights with Sensor	289
Flat and Triangular LED Striplights & Accessories	290 - 291
Under Cabinet Lights	292 - 293
LED Dimmable Under Cabinet Light Kits	294 - 295

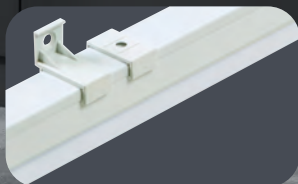
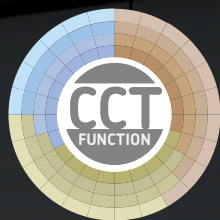

VERTICAL AND HORIZONTAL
FIXINGS INCLUDED



CONNECTION COVER

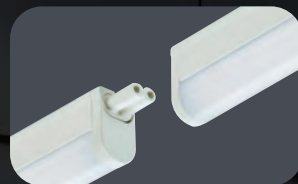

LINKABLE

CCT ADJUSTABLE LED LINKABLE STRIPLIGHTS

Construction: Polycarbonate

Driver: Integral

Lamp type: LED



Width	Projection	(mm)
22.8	36	

Code	Wattage	Colour	CCT	Length	Lumens	Qty
UCLCT4	4W	CCT	3000/4000/6500K	277mm	350/390/370lm	1
UCLCT9	9W	CCT	3000/4000/6500K	538mm	685/690/675lm	1
UCLCT13	13W	CCT	3000/4000/6500K	838mm	1055/1055/1025lm	1
UCLCT18	18W	CCT	3000/4000/6500K	1138mm	1675/1915/1780lm	1

ACCESSORIES

Code	Model	Length
UC250	Link Power Cord	250mm
UC500	Link Power Cord	500mm
UC1000	Link Power Cord	1000mm
UCP200	Power Cable	2000mm
UCCUP	Coupler / Connector	



Ultra-slim LED striplights, ideal for kitchen lighting, cabinet lighting, cove lighting, and retail applications. Linkable end-to-end by a coupler (included) or using link leads (available separately). Up to a maximum of 12 units can be interlinked to each other

- Integral driver, independently switched
- Energy efficient and long life
- Emits an even light distribution
- Versatile and simple to install
- Mountable horizontally or vertically
- Fixing kit supplied



Supplied with 2m power cord, small coupler connector, and fixing clips



LED LINKABLE STRIPLIGHTS

Construction: Polycarbonate

Driver: Integral

Lamp type: LED

Width	Projection	(mm)
22.8	36	



Code	Wattage	Colour	CCT	Length	Lumens	Qty
UCLED4WW	4W	Warm White	3000K	277mm	310lm	1
UCLED7WW	7W	Warm White	3000K	395mm	530lm	1
UCLED9WW	9W	Warm White	3000K	538mm	640lm	1
UCLED13WW	13W	Warm White	3000K	838mm	950lm	1
UCLED18WW	18W	Warm White	3000K	1138mm	1450lm	1
UCLED22WW	22W	Warm White	3000K	1438mm	1550lm	1
UCLED4CW	4W	Cool White	4000K	277mm	360lm	1
UCLED7CW	7W	Cool White	4000K	395mm	570lm	1
UCLED9CW	9W	Cool White	4000K	538mm	760lm	1
UCLED13CW	13W	Cool White	4000K	838mm	1020lm	1
UCLED18CW	18W	Cool White	4000K	1138mm	1550lm	1
UCLED22CW	22W	Cool White	4000K	1438mm	1730lm	1



VERTICAL AND HORIZONTAL FIXINGS INCLUDED



CONNECTION COVER



LINKABLE

Supplied with 2m power cord, small coupler connector, and fixing clips





ACCESSORIES

Code	Model	Length
UC250	Link Power Cord	250mm
UC500	Link Power Cord	500mm
UC1000	Link Power Cord	1000mm
UCP200	Power Cable	2000mm
UCCUP	Coupler / Connector	





SENSOR FUNCTION
Turn on/off with hand motion, helps prevent the spread of bacteria



LED MAINS VOLTAGE LINKABLE STRIPLIGHT WITH ON/OFF MOTION SENSOR

Slim low-profile design with integrated LED driver, constructed from aluminium and polycarbonate. Produces an even light distribution. Ideal applications: under cabinets, kitchens, bedrooms, and wardrobes etc.

- Supplied with 2m power cord and fixings
- A maximum of 15 units can be linked together using optional link lead (not included)

Construction: Aluminium & polycarbonate

Driver: Integral

Lamp type: LED

Width	Height	(mm)
60	28	

Code	Wattage	Colour	CCT	Length	Lumens
USLED73K	7W	Warm White	3000K	362mm	490lm
USLED123K	12W	Warm White	3000K	562mm	740lm
USLED7	7W	Cool White	4000K	362mm	500lm
USLED12	12W	Cool White	4000K	562mm	780lm

230V
50Hz

IP20

LAMP
INCLUDED

3
YEAR
WARRANTY



FLAT LED STRIPLIGHTS

- Supplied with coupler, 1m power cord, and fixing kit

Construction: Extruded aluminium

Lamp type: LED

Driver: Required (**LEDAD36**)

Width	Projection	(mm)
33	8	



Code	Wattage	Colour	CCT	Length	Lumens
LED3WWW	3W	Warm White	3000K	310mm	395lm
LED5WWW	5W	Warm White	3000K	510mm	625lm
LED11WWW	11W	Warm White	3000K	1010mm	1325lm
LED3WCW	3W	Cool White	6000K	310mm	385lm
LED5WCW	5W	Cool White	6000K	510mm	580lm
LED11WCW	11W	Cool White	6000K	1010mm	1320lm
LED3WB	3W	Blue	-	310mm	-
LED5WB	5W	Blue	-	510mm	-
LED11WB	11W	Blue	-	1010mm	-

FLAT STRIPLIGHT ESSENTIALS

Code	Model
LEDFLIP	Metal Mounting Clip (with 2 x Screws)
LEDFCON	PVC Connector
LEDTD1	Touch Dimmer
LEDTD2	DC 24V Plug-In Power Connector
LEDRACON	PVC Right Angle Connector



TRIANGULAR LED STRIPLIGHTS

- Supplied with coupler, 1m power cord, and fixing kit

Construction: Extruded aluminium

Lamp type: LED

Driver: Required (**LEDAD36**)

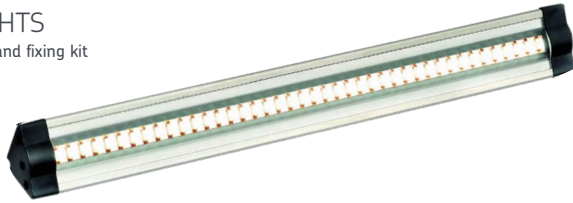

Width	Projection	(mm)
33	20	



Code	Wattage	Colour	CCT	Length	Lumens
LEDT3WWW	3W	Warm White	3000K	300mm	395lm
LEDT5WWW	5W	Warm White	3000K	500mm	625lm
LEDT11WWW	11W	Warm White	3000K	1000mm	1325lm
LEDT3WCW	3W	Cool White	6000K	300mm	385lm
LEDT5WCW	5W	Cool White	6000K	500mm	580lm
LEDT11WCW	11W	Cool White	6000K	1000mm	1320lm

TRIANGULAR STRIPLIGHT ESSENTIALS

Code	Model
LEDTCLIP	Metal Mounting Clip (with 2 x Screws)
LEDTCON	PVC Connector



LEDTCLIP



LEDTCON

FLAT AND TRIANGULAR STRIPLIGHT ESSENTIALS

Code	Model
LEDDIMMER	LED Dimmer
LEDAD36	36W Power Adaptor - Black
LEDAD36W	36W Power Adaptor - White
LED8SPLIT	PVC DC 8-Way Splitter



LEDDIMMER



LEDAD36



LEDAD36W

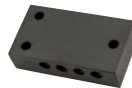

LED8SPLIT

POWER LEADS

- Use to connect additional linear striplights

Code	Length
LED100	100mm
LED250	250mm
LED1000	1000mm
LED2500	2500mm



LED100



LED1000



LED UNDER CABINET LIGHTS

- Suitable for surface or recessed mounting
- Supplied with 1.2m cable

Construction: Pressed steel

Driver: Integral

Lamp type: LED

Projection	Diameter	Cut-out	(mm)
30	71	58	



Code	Wattage	Colour	CCT	Finish	Lumens
CABBCWW	2W	Warm White	3000K	Brushed Chrome	125lm
CABCWW	2W	Warm White	3000K	Chrome	125lm
CABWWW	2W	Warm White	3000K	White	125lm
CABBCCW	2W	Cool White	4000K	Brushed Chrome	140lm
CABCCW	2W	Cool White	4000K	Chrome	140lm
CABWCW	2W	Cool White	4000K	White	140lm



12V UNDER CABINET LIGHTS

- Suitable for surface and recessed mounting

Construction: Pressed steel

Driver: 12V AC transformer required (T02)

Lamp type: 12V G4 10W & 20W Halogen included

Projection	Diameter	Cut-out	(mm)
25	72	60	



Code	Model
CRF02B	Brass
CRF02C	Chrome

Code	Model
CRF02CBR	Brushed Chrome
CRF02W	White



TRIANGULAR LED UNDER CABINET LIGHTS

Construction: Pressed steel

Driver: Integral

Lamp type: LED

Width	Projection	(mm)
128	40	



Code	Wattage	Colour	CCT	Lumens
TRIBCWW	2W	Warm White	3000K	125lm
TRIBCCW	2W	Cool White	4000K	140lm



LED DIMMABLE UNDER CABINET LIGHTS

Stylish, low profile, under-cabinet LED kit.

Supplied complete with 3 lights, 6-way connector, and a dimmable LED remote driver.

- Users can add additional lights (up to 6 per driver)
- Suitable for surface and recessed mounting
- Pre-wired with 2.5m cable
- Available as single lights, as well as packs of 3

Construction: Polycarbonate

Driver: Included with kits (not included with single lights)

Lamp type: LED



CONVENIENT ALL-IN-ONE KITS

Included:
 3 x 2.5W lights
 1 x 6-way connector
 1 x dimmable driver

Diameter	Projection	Cut-out Ø (mm)
68	11	63

Code	Wattage	Finish	Colour	CCT	Lumens
UNDKIT3WWW	3 x 2.5W	White	Warm White	3000K	195lm
UNDKIT3BCWW	3 x 2.5W	Brushed Chrome	Warm White	3000K	185lm
UNDKIT3WCW	3 x 2.5W	White	Cool White	4000K	225lm
UNDKIT3BCCW	3 x 2.5W	Brushed Chrome	Cool White	4000K	220lm



RECESS MOUNTED SURFACE MOUNTED

LED UNDER CABINET LIGHTS (SINGLE)

Code	Wattage	Finish	Colour	CCT	Lumens
UNDK3WWW	2.5W	White	Warm White	3000K	195lm
UNDK3BCWW	2.5W	Brushed Chrome	Warm White	3000K	185lm
UNDK3WCW	2.5W	White	Cool White	4000K	225lm
UNDK3BCCW	2.5W	Brushed Chrome	Cool White	4000K	220lm

UNDKIT 6-WAY CONNECTOR

Code	Model
UNDKCON	6-Way Connector



230V
50Hz

IP20





LED FLEX

Extremely versatile and adaptable, LED Flex can be used to create stunning ambient lighting effects across a wide range of applications

Introduction to Flex-cut	298 - 299
Single Colour LED Flex	300
Aluminium Profiles	301
LED Flex Remotes and Controllers	302
LED Flex Connectors / Fixing Kit	303
LED Flex Drivers and Amplifiers	304

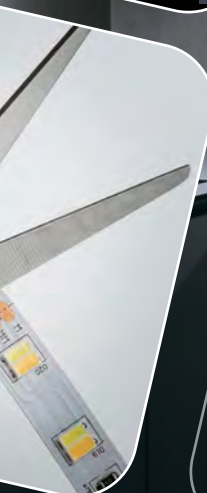



NEW

FLEX-CUT

THE BESPOKE ONLINE LED STRIP CUTTING SERVICE FROM KNIGHTSBRIDGE

Buying LED Flex has never been simpler – tailor multiple LED Flex setups to suit your needs, in just five easy steps! Available to all registered customers at miaccessories.co.uk

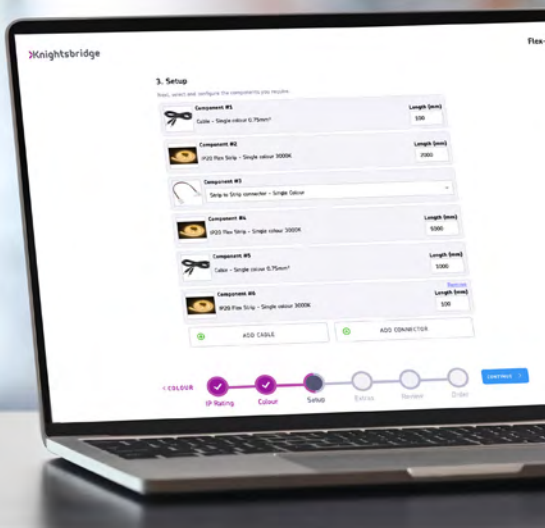

HOW IT WORKS



PICK YOUR IP RATING

Select the level of water protection you need for the job



PICK YOUR COLOUR

Select the colour of the light output you require – we offer a huge range of lighting options



SELECT YOUR SETUP

Specify your desired cable and flex strip length



TAILOR YOUR LED FLEX

Add any required drivers, controllers, and aluminium profiles to your order



FINISH

Review and place your order

**30M/50M REELS AVAILABLE
CONTACT US FOR MORE INFORMATION**

WHY CHOOSE LED FLEX?



HIGHLY VERSATILE

Our LED Flex range is extremely versatile and adaptable, with a huge array of different lighting colours and outputs, including colour-changing, high lumen and IP65 options. Whatever the application, we're sure to have the perfect fit!

AMBIENT LIGHTING EFFECTS

Create stunning ambient lighting effects anywhere indoors or outdoors, with subtle tones that can complement any space. LED Flex can be particularly effective for illuminating under-cabinet spaces in kitchens, but the possibilities are endless!

LED FLEX REMOTES AND CONTROLLERS

A selection of remotes and controllers for use with Knightsbridge LED Flex, ranging from basic button remotes to touch panel remotes for an extensive range of dimming colour controls

REMOTE CONTROL

Our range of LED Flex lighting can be controlled remotely, either by a remote control or (when installed with our Smart LEDFWIFI controller) via the SmartKnight App on your smartphone. The SmartKnight app enables scene control, geo-fencing, and other creative and convenient ways to control your lighting.



OPTIONS AVAILABLE:

IP20 24V

- Warm white / cool white / daylight
- Red / blue / green / yellow
- CCT / RGB / RGBW adjustable

IP67 24V

- Warm white / cool white / daylight
- CCT / RGB adjustable

IP20 24V

HIGH LUMEN

- Warm white / cool white / daylight



VISIT MLACCESSORIES.CO.UK AND CLICK 'FLEX-CUT' TO GET STARTED!



12V IP20 SINGLE COLOUR LED FLEX

- Dimmable when using **LEDFR1** and **LEDFR7** remote control unit, or when using constant voltage dimmable drivers (not included)

Driver: Required

Compatible remotes: LEDFR1 or LEDFR7

12V

IP20



Code	Watts/mtr	LEDs/mtr	Colour	CCT	Width	Length	Lumens/mtr	
LFX512WW	4.8W	60	Warm White	3000K	8mm	5m	510lm	NEW
LFX512CW	4.8W	60	Cool White	4000K	8mm	5m	535lm	NEW
LFX512DL	4.8W	60	Daylight	6000K	8mm	5m	520lm	NEW



FOR ALL OTHER LED FLEX OPTIONS, INCLUDING HIGH-LUMEN AND COLOUR-CHANGING OPTIONS, PLEASE REFER TO DETAILS ON OUR NEW LED FLEX CUTTING SERVICE - PAGES 298 - 299



1MPSC



1MPRF



1MPSF

ALUMINIUM PROFILES

- Compatible with our full range of IP20 single colour, CCT, and RGB flex
- Maximum flex width 10mm

Code	Model	Width	Height	Recessed Depth	Length
1MPSC	Surface Mount Corner	18mm	18mm		1m
1MPRF	Recessed Flat	25mm	2.5mm	5.5mm	1m
1MPSF	Surface Mount Flat	18mm	10mm		1m



LED FR1



LED FR2



LED FR5



LED FR6



LED FR4



LED FR7



LED FR8

LED FLEX REMOTES AND CONTROLLERS

A selection of remotes and controllers for use with Knightsbridge LED flex, ranging from basic button remotes to touch panel remotes for an extensive range of dimming colour controls

Code	Model	12V	24V
LED FR1	12V / 24V Inline RF Controller and Remote - Dimmer Single Colour	72W	144W
LED FR2	12V / 24V IR Controller and Remote - CCT	72W	144W
LED FR4	12V / 24V IR Controller and Remote - RGB	72W	144W
LED FR5	12V / 24V RF Touch Controller and Remote - RGB	216W	432W
LED FR6	12V / 24V RF Touch Controller and Remote - RGBW	288W	576W
LED FR7	12V / 24V RF Controller and Touch Remote - Dimmer Single Colour	216W	432W
LED FR8	12V / 24V RF Controller and Touch Remote - CCT	144W	288W



VISIT **SMART HOME** on pages 213

SMART LED FLEX CONTROLLER

- Compatible with single colour, CCT, RGB, and RGBW flex
- Enables users to adjust the colour temperature of their LED Flex via the Smartnight app
- RGB and RGBW LED flex only: enables users to adjust the RGB colour, with over 16 million colour options, via the Smartnight app

Works with Alexa and Hey Google. See page 213



Code	Model
LED FWIFI	12V / 24V



Amazon, Alexa and all related logos are trademarks of Amazon.com, Inc. or its affiliates.

Google is a trademark of Google LLC.



LED FLEX CONNECTORS

- Strip-to-strip solderless connectors
- For 12V and 24V LED flex

Code	Model
CONFLEX2P	Strip-to-Strip Connector - Single Colour
CONFLEX3P	Strip-to-Strip Connector - CCT
CONFLEX4P	Strip-to-Strip Connector - RGB
CONFLEX5P	Strip-to-Strip Connector - RGBW



IP20 12V/24V FLEX CONNECTOR

Code	Model
FLEXCON	12 / 24V 8mm Single Colour Male and Female Connector



SINGLE COLOUR LED FLEX SOLDERLESS CONNECTORS (12V AND 24V)

- For 8mm 12V and 24V single colour LED flex

Code	Model
CON2P	Connector (pack of 2) - Single Colour
CONX2P	4-Way Connector - Single Colour



FIXING KIT

- Fixing kit for IP LED flex (5 clips per pack)

Code	Model
FLEXFIX	Mounting Kit - Single Colour
FLEXFIXL	Mounting Kit - CCT/RGB/RGBW



AMPLIFIERS

- Signal amplifier - 12V and 24V compatible
- Enables LED Flex to be extended but continues to use one source of control
- Prevents voltage and signal drop

Code	Model
LEDAMP	LED Amplifier
RGBAMP	RGB Amplifier



IP20 12V LED CONSTANT VOLTAGE DRIVERS

Code	Model	
12VDCA	12V 12W	
12DC40	12V 40W	
12DC75	12V 75W	NEW



IP20 24V LED CONSTANT VOLTAGE DRIVERS

Code	Model	
24VDCA	24V 12W	
24DC40	24V 40W	
24DC75	24V 75W	NEW



IP67 CONSTANT VOLTAGE DRIVERS

Code	Model	
12DCIP40	12V 40W	NEW
24DCIP40	24V 40W	NEW
24DCIP75	24V 75W	NEW
24DCIP100A	24V 100W	NEW

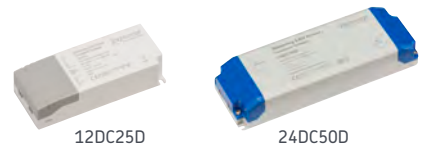

IP20 LED DIMMABLE CONSTANT VOLTAGE DRIVERS

- Compatible with most trailing-edge dimmers

Code	Model
12DC25D	12V 25W
12DC50D	12V 50W
24DC25D	24V 25W
24DC50D	24V 50W
24DC100D	24V 100W



Subscribe to our YouTube channel for product demos, technical FAQs, and more!

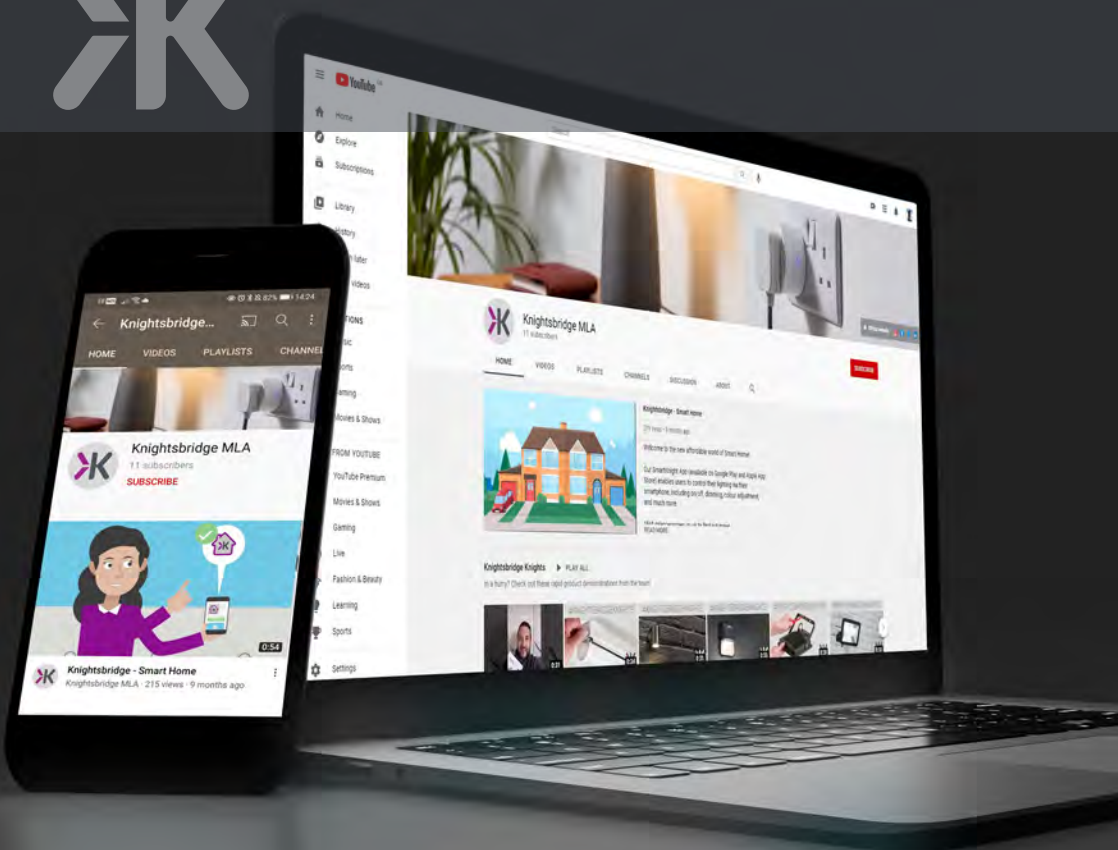



OUTDOOR LIGHTING

OUTDOOR WALL LIGHTS & BOLLARDS

A comprehensive range of decorative outdoor wall and bollard lighting, perfect for illuminating garden walkways and patios

Wall Lights

IP54 LED Up/Down Wall Lights	309
IP65 Wall Lights	310 - 311
IP44 Wall Lights with PIR Sensor	311
IP65 Heavy Gauge Wall Lights / IP65 Ground Bollard	312 - 313
IP54 Compact Wall Lights	314 - 315
IP65 LED Mini Aluminium LED Wall Lights	317
IP44 LED Wall Lights / IP44 LED Guide Lights	318
IP54 LED Recessed Guide Lights	319
IP44 LED Wall/Guide Lights	320 - 321
IP65 LED Adjustable Up/Down Wall Lights	322
IP54 LED Round Interchangeable Wall Light	323
IP65 LED Surface Mount Bricklights	324 - 325
IP54 LED Bricklight / IP44 E27 Bricklight	326
IP44 Window/Slotted Wall Lights	327
IP54 LED Lanterns	328 - 329
IP23 Stainless Steel Lanterns	330
IP33 E27 Wall Lantern / IP54 Dome Bulkheads	331

Bollards/Wall Lights

E27 Cylinder Outdoor Wall Light and Pedestal	333
E27 Outdoor Wall Light, Pedestal and Bollard	334
GU10 Outdoor Wall Light and Bollards	335

Note: Some of our outdoor products may not be suitable for use in coastal areas where salt corrosion is prevalent



THE PERFECT FIT FOR OUTDOORS



FLOODLIGHTS



HEATERS

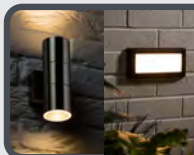

WALL LIGHTS



WEATHERPROOF ACCESSORIES

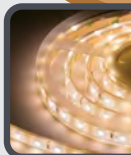

LED FLEX



SPIKE LIGHTS



SENSORS

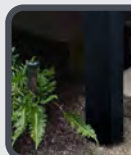

BOLLARDS



GROUND LIGHTS



LED UP/DOWN WALL LIGHTS

- Provides a striking up/down lighting effect

Height	Projection	(mm)
100	50	

Construction: 304 Stainless steel
Driver: Integral
Lamp type: LED

230V
50Hz

IP54



3
YEAR
WARRANTY



Code	Wattage	Width	Finish	Colour	CCT	Lumens
WSS8A	2 x 4W	100mm	Anthracite	Warm White	3500K	450lm
WSS8BC	2 x 4W	100mm	Brushed Chrome	Warm White	3500K	450lm
WSS8W	2 x 4W	100mm	White	Warm White	3500K	450lm
WSM16A	2 x 8W	180mm	Anthracite	Warm White	3500K	880lm
WSM16BC	2 x 8W	180mm	Brushed Chrome	Warm White	3500K	880lm
WSM16W	2 x 8W	180mm	White	Warm White	3500K	880lm

Important: Some of our outdoor lighting products may not be suitable for use in coastal areas where salt corrosion is prevalent.



WALL1L WALL LIGHT

Construction: 304 Stainless steel
(WALL1LBK: Die-cast aluminium)
Lamp type: GU10 LED



Code	Finish	Height	Diameter	Base Ø	Projection
WALL1L	Stainless Steel	120mm	60mm	78mm	86mm
WALL1LBK	Black	112mm	64mm	78mm	94mm
WALL1LC	Copper Effect	120mm	60mm	78mm	86mm

WALL2L UP / DOWN WALL LIGHT

Construction: 304 Stainless steel
(WALL2LBK: Die-cast aluminium)
Lamp type: GU10 LED



Code	Finish	Height	Diameter	Base Ø	Projection
WALL2L	Stainless Steel	162mm	60mm	78mm	86mm
WALL2LBK	Black	166mm	64mm	78mm	94mm
WALL2LC	Copper Effect	162mm	60mm	78mm	86mm



FOR MATCHING
SPIKE LIGHTS
SEE PAGE 339

WALL3L WALL LIGHT

Construction: 304 Stainless steel
(WALL3LBK: Die-cast aluminium)

Lamp type: GU10 LED



230V
50Hz

IP65



Code	Finish	Height	Diameter	Base Ø	Projection
WALL3L	Stainless Steel	140mm	60mm	78mm	155mm
WALL3LBK	Black	145mm	64mm	78mm	166mm
WALL3LC	Copper Effect	140mm	60mm	78mm	155mm

WALL4L UP/DOWN WALL LIGHT WITH PIR SENSOR

- Sensor detection range 8m when mounted at 2.4m
- PIR field of detection: 110°
- Includes manual override

Construction: 304 Stainless steel

Lamp type: GU10 LED



Code	Finish	Height	Diameter	Projection
WALL4LSS	Stainless Steel	222mm	60mm	112mm

230V
50Hz

IP44



WALL5L WALL LIGHT WITH PIR SENSOR

- Sensor detection range 8m when mounted at 2.4m
- PIR field of detection: 110°
- Includes manual override

Construction: 304 Stainless steel

Lamp type: GU10 LED

Code	Finish	Height	Diameter	Projection
WALL5LSS	Stainless Steel	184mm	60mm	112mm

230V
50Hz

IP44



Important:

Some of our outdoor lighting products may not be suitable for use in coastal areas where salt corrosion is prevalent.



WALL1



WALL3



WALL2



FOR MATCHING
SPIKE LIGHTS
SEE PAGE 338

HEAVY GAUGE WALL LIGHTS

Construction: 304 Stainless steel

Lamp type: GU10 LED

230V
50Hz

IP65



Code	Finish	Height	Diameter	Base	Projection
WALL1	Stainless Steel	108mm	62mm	76mm	92mm
WALL2	Stainless Steel	160mm	62mm	76mm	92mm
WALL3	Stainless Steel	140mm	62mm	76mm	162mm

GROUND BOLLARD

Construction: 304 Stainless steel

Lamp type: GU10 LED

Code	Finish	Height
GROUND2	Stainless Steel	260mm



230V
50Hz

IP65



Important: Some of our outdoor lighting products may not be suitable for use in coastal areas where salt corrosion is prevalent.



PREMIUM HEAVY
GAUGE DESIGN
PROFESSIONAL WALL LIGHTS



COMPACT-DESIGN WALL LIGHTS



SINGLE FITTINGS

Construction: 201 Stainless steel
Lamp type: GU10 LED



Code	Finish	Height	Diameter	Projection	
OWALL1A	Anthracite	120mm	60mm	96mm	NEW
OWALL1BC	Brushed Chrome	120mm	60mm	96mm	NEW
OWALL1BK	Black	120mm	60mm	96mm	NEW
OWALL1W	White	120mm	60mm	96mm	NEW



UP/DOWN FITTINGS

Construction: 201 Stainless steel
Lamp type: GU10 LED x 2



Code	Finish	Height	Diameter	Projection	
OWALL2A	Anthracite	170mm	60mm	96mm	NEW
OWALL2BC	Brushed Chrome	170mm	60mm	96mm	NEW
OWALL2BK	Black	170mm	60mm	96mm	NEW
OWALL2W	White	170mm	60mm	96mm	NEW

DAYLIGHT SENSOR MODELS

Construction: 201 Stainless steel
Lamp type: GU10 LED x 2



OWALL2AP	Anthracite	170mm	60mm	98mm	NEW
OWALL2BCP	Brushed Chrome	170mm	60mm	98mm	NEW
OWALL2BKP	Black	170mm	60mm	98mm	NEW
OWALL2WP	White	170mm	60mm	98mm	NEW

Important:

Some of our outdoor lighting products may not be suitable for use in coastal areas where salt corrosion is prevalent.



KNOW YOUR IP RATING

IPXX

First digit

Indicates the level of protection against access to hazardous parts and the ingress of solid objects

1

>50mm

Protection against any large surface of the body, such as the back of a hand, but no protection against deliberate contact

2

>12.5mm

Protection against fingers or similar objects

3

>2.5mm

Protection against tools, thick wires, etc

4

>1mm

Protection against most wires, slender screws, large insects etc

5

Dust protected

Protection against dust that may harm equipment

6

Dust tight

No ingress of dust; complete protection against ingress

Second digit

Indicates the level of protection against the harmful ingress of water

1

Dripping water

Protection against vertical drops when mounted in an upright position onto a turntable and rotated at 1 RPM

2

Dripping water (tilted)

Protection against water droplets when tilted up to 15° from vertical

3

Spraying water

Protection against water spray from all up to an angle of 60 degrees

4

Splashing water

Protection against splashing water from any direction

5

Water jets

Protection against low pressure jets of water from any direction

6

Powerful Water jets

Protection against high pressure jets of water from any direction

Please note, IPX7 and IPX8 are tested using different methods from IPX6 and below. Products with IPX7 or IPX8 ratings are not necessarily protected from water jets or splashes

7

Immersion up to 1m

Protection from immersion in water under defined conditions of pressure and time

8

Immersion beyond 1m

Protection from immersion in water under defined conditions of pressure and time



MINI ALUMINIUM LED WALL LIGHTS

- Contemporary lightweight design, constructed with an aluminium body, suitable for indoor and outdoor use
- Compact sized outdoor lights with integral LED
- Energy efficient, low-maintenance and long-life



LWALL1A



LWALL2A

230V
50Hz

IP65



Construction: Aluminium

Driver: Integral

Lamp type: CoB LED

Overall Ø	Base Ø	Projection	(mm)
49	62	80	

Code	Wattage	Finish	Colour	CCT	Height	Lumens
LWALL1A	4W	Brushed Chrome	Warm White	3000K	81mm	175lm
LWALL2A	2 x 4W	Brushed Chrome	Warm White	3000K	135mm	435lm

MINI ALUMINIUM LED ADJUSTABLE WALL LIGHT

Construction: Aluminium

Driver: Integral

Lamp type: CoB LED



230V
50Hz

IP65



Overall Ø	Base Ø	Projection	(mm)
49	62	139	

Code	Wattage	Finish	Colour	CCT	Lumens
LWALL3A	4W	Brushed Chrome	Warm White	3000K	175lm

Important:

Some of our outdoor lighting products may not be suitable for use in coastal areas where salt corrosion is prevalent.



FOR MATCHING
SPIKE LIGHT
SEE PAGE 343



NH021W



NH022W



LED STAINLESS STEEL EXTERIOR WALL LIGHTS

Construction: 304 Stainless steel

Driver: Integral

Lamp type: LED

230V
50Hz

IP44



Code	Wattage	Finish	Colour	CCT	Height	Width	Projection	Lumens
NH021W	2 x 3W	Stainless Steel	Cool White	4000K	147mm	60mm	95mm	30lm
NH022W	2 x 3W	Stainless Steel	Daylight	6000K	147mm	70mm	73mm	30lm



NH016W



NH017W

LED GUIDE / STAIR / WALL LIGHTS

Construction: Die-cast aluminium

Driver: Integral

Lamp type: LED

Height	Width	Cut-out Ø	Recessed Depth	(mm)	230V 50Hz	IP44			
121	121	110	70						

Code	Wattage	Finish	Colour	CCT	Lumens
NH016W	0.8W	Grey	Daylight	6000K	23lm
NH017W	0.8W	Grey	Daylight	6000K	23lm



NH020W



NH020B



NH019W

WHITE / BLUE RECESSED LED GUIDE LIGHTS

Construction: Die-cast aluminium

Driver: Integral

Lamp type: LED

Height	Width	Cut-out Ø	Recessed Depth	(mm)	230V 50Hz	IP54			
80	80	75	50						

Code	Wattage	Finish	Colour	CCT	Lumens
NH020B	1W	Matt White	Blue	-	-
NH020W	1W	Matt White	Daylight	6000K	23lm
NH019W	1W	Matt White	Daylight	6000K	23lm

Important:

Some of our outdoor lighting products may not be suitable for use in coastal areas where salt corrosion is prevalent.



LWR4G

LWR2W

LWS4G

LWS2W

LED WALL / GUIDE LIGHTS

Construction: Aluminium

Driver: Integral

Lamp type: LED

230V
50Hz

IP44



Code	Shape	Wattage	Finish	Colour	CCT	Diameter	Projection	Lumens
LWR2G	Round	2W	Grey	Warm White	3500K	115mm	28mm	100lm
LWR2W	Round	2W	White	Warm White	3500K	115mm	28mm	100lm
LWR4G	Round	4W	Grey	Warm White	3500K	220mm	28mm	210lm
LWR4W	Round	4W	White	Warm White	3500K	220mm	28mm	210lm

Code	Shape	Wattage	Finish	Colour	CCT	Height	Width	Projection	Lumens
LWS2G	Square	2W	Grey	Warm White	3500K	105mm	105mm	28mm	100lm
LWS2W	Square	2W	White	Warm White	3500K	105mm	105mm	28mm	100lm
LWS4G	Square	4W	Grey	Warm White	3500K	200mm	200mm	28mm	200lm
LWS4W	Square	4W	White	Warm White	3500K	200mm	200mm	28mm	200lm



- Suitable for both indoor and outdoor applications
- Low maintenance
- Surface mounted for directional, focused, soft lighting



RWL2A

RWL5W

LED GUIDE LIGHTS

Construction: Aluminium

Driver: Integral

Lamp type: LED



Code	Wattage	Finish	Colour	CCT	Height	Width	Projection	Lumens
RWL2A	2W	Anthracite	Warm White	3500K	140mm	100mm	32mm	105lm
RWL2W	2W	White	Warm White	3500K	140mm	100mm	32mm	105lm
RWL5A	5W	Anthracite	Warm White	3500K	70mm	200mm	33mm	230lm
RWL5W	5W	White	Warm White	3500K	70mm	200mm	33mm	230lm

Important:

Some of our outdoor lighting products may not be suitable for use in coastal areas where salt corrosion is prevalent.



ADJUSTABLE UP / DOWN WALL LIGHTS

- Adjustable beam angle, from 0° to 100°
- Independently adjustable lighting effect

Construction: Die-cast aluminium

Driver: Integral

Lamp type: CoB LED

Height	Width	Projection	(mm)
125	100	100	

230V 50Hz	IP65			3 YEAR WARRANTY	
--------------	------	--	--	-----------------------	--

Code	Wattage	Finish	Colour	CCT	Lumens
WAD12AA	2 x 6W	Anthracite	Warm White	3000K	2 x 330lm
WAD12ABK	2 x 6W	Matt Black	Warm White	3000K	2 x 330lm



LED ROUND WALL LIGHT WITH INTERCHANGEABLE PLATE

- Supplied with 2 magnetic interchangeable plate options

Construction: Die-cast aluminium

Driver: Integral

Lamp type: LED

Overall Ø	Projection	(mm)
155	48	

230V 50Hz	IP54			3 YEAR WARRANTY	
--------------	------	--	--	-----------------------	--

Code	Wattage	Finish	Colour	CCT	Lumens
RD10BK	10W	Matt Black	Warm White	3000K	570lm

Important:

Some of our outdoor lighting products may not be suitable for use in coastal areas where salt corrosion is prevalent.



SURFACE MOUNT LED BRICKLIGHTS

- Robust, polycarbonate construction, ideal for outdoor path and walkway lighting. slim profile, surface mount installation can avoid additional cut-out while achieving similar bricklight look and feel.
- Colour temperature adjustable (3000K or 4000K), and blue light output models available
- Supplied with 3 x accessories (grill, louvre, shade)
- Kit available to transform fitting to retrofit, recessed bricklight (not included)

Construction: Polycarbonate

Driver: Integral

Lamp type: LED

Height	Length	Projection	(mm)
100	235	32	



Code	Wattage	Finish	Colour	CCT	Lumens	
BL5BK	5W	Black	CCT	3000/4000K	495/530lm	NEW
BL5G	5W	Grey	CCT	3000/4000K	495/530lm	NEW





Code	Wattage	Finish	Colour	CCT
BL5BLBK	5W	Black	Blue	- NEW
BL5BLG	5W	Grey	Blue	- NEW

RETROFIT KITS

- Back box accessory kit to convert BL5xx fitting to a bricklight, enabling retrofitting or replace existing installations

Height	Length	Projection	Cut-out	(mm)
100	235	14	L/H/D 197 x 70 x 56	
Code	Model			
BLKITBK	Retrofit Kit - Black			NEW
BLKITG	Retrofit Kit - Grey			NEW





LED BRICKLIGHT

- Supplied complete with 2 fascia plates
- plain and louvre/grille

Construction: Aluminium

Driver: Integral

Lamp type: LED

Height	Length	Recessed Depth	Cut-out L/H/D (mm)
101	235	70	226 x 86 x 70

230V
50Hz

IP54



Code	Wattage	Finish	Colour	CCT	Lumens
BLED5BB	5W	Black	Blue	-	-
BLED5BW	5W	Black	Warm White	3500K	110lm
BLED5SB	5W	Brushed Steel	Blue	-	-
BLED5SW	5W	Brushed Steel	Warm White	3500K	110lm

E27 BRICKLIGHT

- Supplied complete with 2 fascia plates
- plain and louvre/grille

Construction: Die-cast aluminium

Driver: Not required

Lamp type: E27 (40W Max.)



Height	Length	Recessed Depth	Cut-out L/H/D (mm)
100	235	75	228 x 88 x 90

230V
50Hz

IP44



Code	Finish
BL01BK	Black



NH027



NH028S

STAINLESS STEEL EXTERIOR WALL LIGHTS

Construction: 201 Stainless steel

Driver: Not required

Lamp type: E27 (40W Max.)

Height	Width	(mm)
276	205	



Code	Model	Finish	Projection
NH027	Window Fascia	Stainless Steel	90mm
NH027S	Window Fascia with PIR	Stainless Steel	96mm
NH028	Slotted Fascia	Stainless Steel	90mm
NH028S	Slotted Fascia with PIR	Stainless Steel	96mm

Important:

Some of our outdoor lighting products may not be suitable for use in coastal areas where salt corrosion is prevalent.



NEW

PHOTOCELL MODELS

EXTERIOR LED LANTERNS

- Durable, corrosion-resilient construction
- Low-maintenance, long-life and energy efficient
- Sensor detection angle 90° with manual override (PIR models)

Construction: Polycarbonate

Driver: Integral

Lamp type: LED

Height	Width	Base Ø	Projection (mm)
375	177	97	230

230V
50Hz

IP54



3
YEAR
WARRANTY



Code	Wattage	Model	Finish	Colour	CCT	Lumens	
LANT1	8W	Standard	Black	Cool White	4000K	400lm	
LANT1W	8W	Standard	White	Cool White	4000K	400lm	
LANT2	8W	With PIR	Black	Cool White	4000K	400lm	
LANT2W	8W	With PIR	White	Cool White	4000K	400lm	
LANT1BKP	8W	Photocell Sensor	Black	Cool White	4000K	555lm	NEW
LANT1WP	8W	Photocell Sensor	White	Cool White	4000K	555lm	NEW



EXTERIOR LED HALF-LANTERNS

- Sensor detection angle 90° with manual override (PIR models)

Construction: Polycarbonate

Driver: Integral

Lamp type: LED

Height	Width	Projection	(mm)
362	175	99	

230V
50Hz

IP54



3
YEAR
WARRANTY



Code	Wattage	Model	Finish	Colour	CCT	Lumens	
LANT3	8W	Standard	Black	Cool White	4000K	270lm	
LANT3W	8W	Standard	White	Cool White	4000K	270lm	
LANT4	8W	With PIR	Black	Cool White	4000K	270lm	
LANT4W	8W	With PIR	White	Cool White	4000K	270lm	
LANT3BKP	8W	Photocell Sensor	Black	Cool White	4000K	555lm	NEW
LANT3WP	8W	Photocell Sensor	White	Cool White	4000K	555lm	NEW



STAINLESS STEEL LANTERN

- Stainless steel with clear glass
- Powder-coated finish
- LED compatible

Construction: 304 Stainless steel

Driver: Not required

Lamp type: E27 (40W Max.)

Height	Width	Base	Projection (mm)
200	120	H: 100 W:78	150

Code	Finish
LANTBK	Anthracite
LANTSS	Brushed Chrome

Important:

Some of our outdoor lighting products may not be suitable for use in coastal areas where salt corrosion is prevalent.





E27 WALL LANTERN

- Sensor detection range 5m when mounted at 1.5m
- Timer: 4 minutes
- No manual override

Construction: Die-cast aluminium

Driver: Not required

Lamp type: E27 (60W Max.)

Height	Width	Projection	(mm)
365	165	98	

Code	Model	Finish
5401A	With PIR	Black



E27 DOME BULKHEADS

Construction: Aluminium & glass

Lamp type: E27 (60W Max.)

Height	Width	Projection (mm)
210	100	110

Code	Model
TPOV60B	Black
TPOV60W	White





WALL LIGHTS WITH MATCHING BOLLARDS

Consistent designs for outdoor spaces



OLG1W

OLG1P

E27 CYLINDER OUTDOOR WALL LIGHT

A contemporary take on the look and feel of a traditional lantern

- Thick, hard-wearing glass design for a premium look and feel

Construction: Aluminium & glass

Driver: Not required

Lamp type: E27 GLS (15W Max.)

Code	Model	Height	Diameter	Projection	
OLG1W	Wall Light	295mm	130mm	185mm	NEW
OLG1P	Pedestal	500mm	150mm	-	NEW



Important:

Some of our outdoor lighting products may not be suitable for use in coastal areas where salt corrosion is prevalent.



OL01P



OL01B



OL01W

E27 OUTDOOR WALL LIGHT, PEDESTAL AND BOLLARD

- Opal polycarbonate 360° diffuser

Construction: Die-cast aluminium

Driver: Not required

Lamp type: E27 (20W Max.)

230V
50Hz

IP54



Code	Model	Height	Width	Depth	Projection
OL01W	Wall Light	245mm	108mm	-	148mm
OL01P	Pedestal	265mm	108mm	108mm	-
OL01B	Bollard	650mm	108mm	108mm	-



GU10 WALL LIGHT / BOLLARDS

Construction: 304 Stainless steel

Lamp type: GU10 LED

230V
50Hz

IP54



Code	Model	Diameter	Height	Projection
GDL1	GU10 Wall Light	102mm	195mm	144mm
GDL2	GU10 Bollard	102mm	650mm	-
GDL3	GU10 Bollard	102mm	1100mm	-
GDLMK23	Mounting Kit for GDL2 and GDL3	135mm	155mm	-
GDLSPIKE2	Ground Spike for GDL2	87mm	400mm	-

Important:

Some of our outdoor lighting products may not be suitable for use in coastal areas where salt corrosion is prevalent.



OUTDOOR LIGHTING

SPIKE LIGHTS

Perfect for illuminating garden walkways, flower beds, water features, and more. With picturesque results, these are an Instagram favourite!

GU10 Spike Lights

338 - 341

LED Spike Lights

342 - 343

Note: Some of our outdoor products may not be suitable for use in coastal areas where salt corrosion is prevalent





SPIKE LIGHTS

- Supplied with 3m cable

Construction: 304 Stainless steel (GU10SPIKE)

Die-cast aluminium (GU10SPIKEBK)

Driver: Not required

Lamp type: GU10 LED

Overall Ø	Height	Spike Length	(mm)
63	250	120	

Code	Finish
GU10SPIKE	Stainless Steel
GU10SPIKEBK	Black





LIGHT GAUGE SPIKE LIGHT

- Supplied with 2m cable

Construction: 304 Stainless steel

Driver: Not required

Lamp type: GU10 LED

Overall Ø	Height	Spike Length	(mm)
60	250	120	

Code	Finish
GU10SPIKEL	Stainless Steel

230V
50Hz

IP65



GU10 LED
LAMPS
PAGE 443

Important:

Some of our outdoor lighting products may not be suitable for use in coastal areas where salt corrosion is prevalent.



BLACK SPIKE LIGHT

- Supplied with 1.5m cable
- Supplied with wall mount and ground spike

Construction: Die-cast Aluminium

Driver: Not Required

Lamp type: GU10 LED

Overall Ø	Height	Spike Length	(mm)
65	330	173	

Code	Finish
SPIKEGUBK	Black

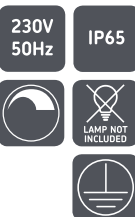

GU10 LED
LAMPS
PAGE 443





Overall Ø	Height	Spike Length	(mm)
98	326	170	

Code	Finish
GUSPBK	Black
GUSPGR	Grey

SPIKEXT1	Black
----------	-------

GROUND SPIKE LIGHT

- Wall-mountable option
- Supplied with 2m cable

Construction: Die-cast aluminium / spike - polycarbonate

Driver: Not required

Lamp type: GU10 LED (10W Max.)



EXTENSION SPIKES

Construction: Stainless steel

Code	Finish	Height
EXT2	Stainless Steel	604mm
EXT3	Black	604mm

Important:

Some of our outdoor lighting products may not be suitable for use in coastal areas where salt corrosion is prevalent.



LED BLACK SPIKE LIGHT

- Supplied with 3m cable
- Supplied with wall mount and spike

Construction: Die-cast aluminium

Lamp type: CoB LED

Overall Ø	Height	Spike Length	(mm)
60	305	173	

Code	Wattage	Finish	Colour	CCT	Lumens	
SPIKE4BL	4W	Black	Warm White	3000K	335lm	NEW



230V
50Hz

IP65



LED BLACK SPIKE LIGHT

- Supplied with 2m cable

Construction: 304 Stainless steel bezel, die-cast aluminium body

Lamp type: CoB LED

Overall Ø	Height	Spike Length	(mm)
95	340	210	

Code	Wattage	Finish	Colour	CCT	Lumens
SPIKE5A	6W	Black	Warm White	3000K	380lm



230V
50Hz

IP65





LED SPIKE LIGHT

- Supplied with 2m cable

Construction: 304 Stainless steel

Lamp type: CoB LED

Overall Ø	Height	Spike Length	(mm)
63	255	110	

Code	Wattage	Finish	Colour	CCT	Lumens
SPIKE5S	6W	Stainless Steel	Warm White	3000K	360lm NEW

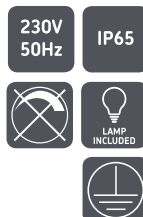

MINI ALUMINIUM LED SPIKE LIGHT

Construction: Aluminium

Lamp type: CoB LED

Overall Ø	Height	Spike Length	(mm)
49	227	110	

Code	Wattage	Finish	Colour	CCT	Lumens
LSPIKEA	4W	Brushed Chrome	Warm White	3000K	175lm

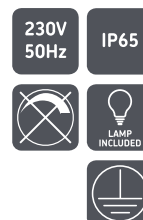

LED SPIKE LIGHT

- 350mA constant current driver required

Construction: 304 Stainless steel

Driver: Required (see page XX)

Lamp type: CoB LED

Overall Ø	Height	Spike Length	(mm)
49	225	120	

Code	Wattage	Finish	Colour	CCT	Lumens
SPIKEW	1W	Stainless Steel	Daylight	6000K	75lm



Important:

Some of our outdoor lighting products may not be suitable for use in coastal areas where salt corrosion is prevalent.



OUTDOOR LIGHTING

GROUNDLIGHTS & DECK LIGHTING

Ideal for driveways, garden walkways, patios and decking areas. These luminaries are small and discreet, but still provide effective guiding illumination

Groundlights

GU10 Groundlights	348 - 349
LED Groundlights / Goundlight with Half Lip	350 - 351
LED Groundlights / LED Shallow Groundlights	352
COB LED Groundlights	353

Deck Lighting

LED Interchangeable Wall / Groundlights	354
LED Decking Kit / LED Decking Lights	354 - 355

Note: Some of our outdoor products may not be suitable for use in coastal areas where salt corrosion is prevalent

Knightsbridge

Committed to a brighter future



At Knightsbridge, we believe in looking after our customers and looking after our planet. This philosophy is important to us and is why we have started to apply it to the way we package and present our products.

We are now working in conjunction with the FSC® moving towards 100% recyclable / 100% recycled packaging solutions. Look out for the FSC® label on our certified packaging.



This is our plan, this is our commitment to a brighter future.



ENVIRONMENTALLY APPROPRIATE forest management ensures that the harvest of timber and non-timber products maintains the forest's biodiversity, productivity, and ecological processes.



SOCIALLY BENEFICIAL forest management helps both local people and society at large to enjoy long term benefits and also provides strong incentives to local people to sustain the forest resources and adhere to long-term management plans.



ECONOMICALLY VIABLE forest management means that forest operations are structured and managed so as to be sufficiently profitable, without generating financial profit at the expense of the forest resource, the ecosystem, or affected communities.

RECOMMENDED GROUND PREPARATION (IP65)

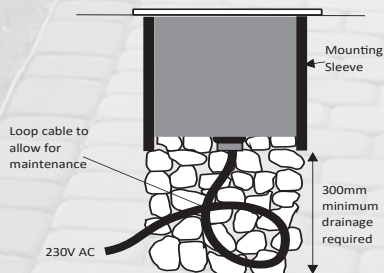

Ensure there is a minimum 300mm 'hole' below the fitting, fill with loose gravel or pea shingle

Test hole by filling with water which should drain away within 30 minutes

Leave cable loop in gravel to allow access and extraction of fitting

Final circuit connection

Use IP68 connection boxes which are gel filled if buried

Joint should be accessible for repair or maintenance

All outdoor circuits should be protected by either an RCD or RCBO

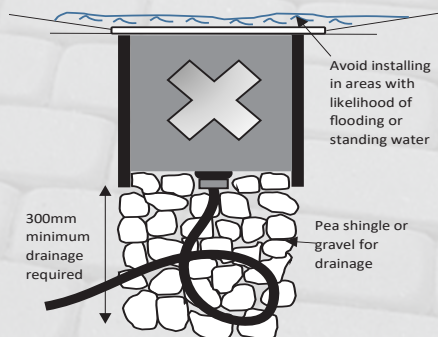
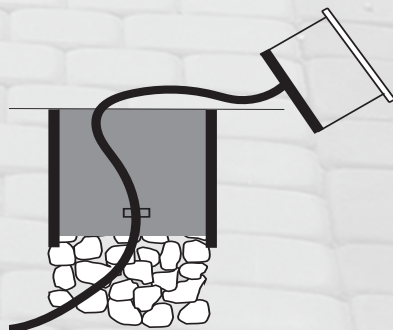

For areas with a low water table or likely to flood leaving 'standing water', IP65 fittings should be avoided.

Fittings with IP67 or IP68 ratings should be used in these installations



GU10 GROUNDLIGHT

Construction: 304 Stainless steel

Driver: Not required

Lamp type: GU10 LED

Bezel Ø	Cut-out Ø	Sleeve Ø	Recessed Depth (mm)
105	80	92	150

Code	Model
WGULEN	Round



-
-
-
-
-
-



WGULED



WSGULED



WHGULED

-
-
-
-
-
-

GU10 GROUNDLIGHT

Construction: 304 Stainless steel

Driver: Not required

Lamp type: GU10 LED

Cut-out Ø	Sleeve Ø	Recessed Depth (mm)
80	92	132

Code	Model	Bezel
WGULED	Round	105mm
WSGULED	Square	100mm x 100mm
WHGULED	Hexagon	115mm x 100mm



316 STAINLESS STEEL GU10 GROUNDLIGHT

Construction: 316 Stainless steel

Driver: Not required

Lamp type: GU10 LED

Bezel Ø	Cut-out Ø	Sleeve Ø	Recessed Depth (mm)
101	80	95	190

Code	Model
316WALK	316 Stainless Steel





LED GROUNDLIGHTS

- Ideal for driveways and decking, safe for indoor and outdoor use
- Supplied with 2m outdoor flexible cable

Construction: 304 Stainless steel

Driver: Integral

Lamp type: LED

Bezel Ø	Cut-out Ø	Sleeve Ø	Recessed Depth (mm)
92	61	78	94

Code	Wattage	Model	Colour	CCT	Lumens
LEDGL3W	3W	Stainless Steel	Warm White	3000K	270lm
LEDGL3D	3W	Stainless Steel	Daylight	6000K	290lm





GROUNDLIGHT WITH HALF LIP

Construction: 304 Stainless steel

Driver: Not required

Lamp type: GU10 LED



Bezel Ø	Cut-out Ø	Sleeve Ø	Recessed Depth	Overall Height	(mm)
88	65	70	109	138	

Code	Model
CAPWGU	Stainless Steel



LED GROUNDLIGHTS

- Pre-wired with 1.5m cable

Construction: Stainless steel & aluminium

Driver: Integral

Lamp type: LED

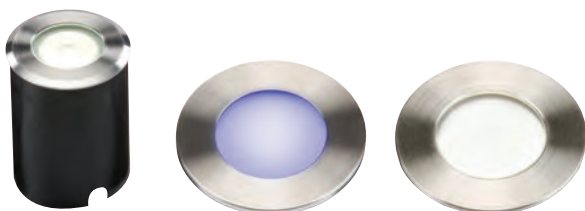

Bezel Ø	Cut-out Ø	Sleeve Ø	Recessed Depth	(mm)	
62	50	60	82.5		
Code	Wattage	Finish	Colour	CCT	Lumens
LEDM07B	1.5W	Stainless Steel	Blue	-	-
LEDM07W	1.5W	Stainless Steel	Cool White	4000K	70lm

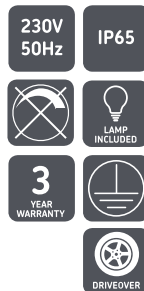

LED SHALLOW GROUNDLIGHTS

- Pre-wired with 2.5m cable
- Supplied with polycarbonate housing
- This fitting is extremely shallow making it very versatile

Construction: Stainless steel & aluminium

Driver: Integral

Lamp type: LED

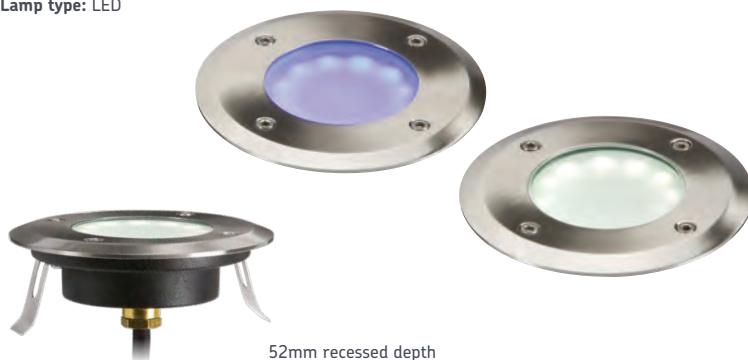

Bezel Ø	Cut-out Ø	Sleeve Ø	Recessed Depth	(mm)	
110	90	97	52		
Code	Wattage	Finish	Colour	CCT	Lumens
LEDM08B1	1.7W	Stainless Steel	Blue	-	-
LEDM08W1	1.7W	Stainless Steel	Cool White	4000K	90lm





COB LED GROUNDLIGHTS

- Pre-wired with 2m cable

Construction: 304 Stainless steel

Driver: Integral

Lamp type: CoB LED



Code	Wattage	Finish	Colour	CCT	Bezel Ø	Sleeve Ø	Recessed Depth	Lumens
LDGL5	5W	Stainless Steel	Warm White	3000K	68mm	60mm	80mm	240lm
LDGL6	6W	Stainless Steel	Warm White	3000K	129mm	114mm	70mm	405lm
LDGL9	9W	Stainless Steel	Warm White	3000K	160mm	144mm	88mm	610lm

LED WALL MARKER / GROUNDLIGHTS

- Supplied with 3 interchangeable chrome effect polycarbonate heads for directional light output
- Suitable for ground and wall installation
- Pre-wired with 2m cable

Construction: Stainless steel & polycarbonate

Driver: Integral

Lamp type: LED

Recessed Depth	Overall Ø	Cut-out	(mm)
48	38	32	

Code	Wattage	Finish	Colour	CCT	Lumens
LEDM06B	0.6W	Brushed Nickel	Blue	-	-
LEDM06W	0.6W	Brushed Nickel	White	6000K	50lm

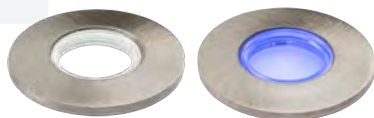

LED DECKING KIT

- 10 x 0.2W LED
- Stainless steel bezels supplied as standard

Construction: Polycarbonate

Driver: Included

Lamp type: LED



Bezel Ø	Cut-out Ø	Recessed Depth	(mm)
30	25	27	

Code	Wattage	Finish	Colour	CCT	Lumens
KIT16WW	2.2W	Stainless Steel	Warm White	3000K	105lm
KIT16W	2.2W	Stainless Steel	Daylight	6000K	90lm
KIT16B	2.2W	Stainless Steel	Blue	-	-



LED DECKING LIGHTS (1W)

- Weight load: 500kg

Construction: 304 Stainless steel

Driver: Integral

Lamp type: LED

Bezel Ø	Cut-out Ø	Sleeve Ø	Recessed Depth (mm)
62	40	60	90

Code	Wattage	Finish	Colour
HPLED1W	1W	Stainless Steel	Daylight

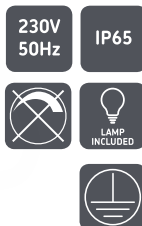

CONSTANT CURRENT LED DECKING LIGHTS

- 350mA constant current driver required

Construction: 304 Stainless steel

Driver: Required - see page 451

Lamp type: LED

Bezel Ø	Cut-out Ø	Recessed Depth (mm)
60	50	40

Code	Wattage	Finish	Colour
1IPB	1W	Stainless Steel	Blue
1IPW	1W	Stainless Steel	Daylight



LED DECKING LIGHTS (0.5W)

- 24V constant voltage

Construction: 304 Stainless steel

Driver: Required

Lamp type: LED

Bezel Ø	Cut-out Ø	Recessed Depth (mm)
36	28	59

Code	Wattage	Finish	Colour
4IPB	0.5W	Stainless Steel	Blue
4IPW	0.5W	Stainless Steel	Cool White







OUTDOOR LIGHTING FLOODLIGHTS & OUTDOOR HEATERS

Floodlights provide an ultra-high lumen solution to any outdoor space - this range includes RGB models and CCT adjustable Spotlights

Lightweight LED Floodlights	358 - 359
High Power LED Floodlights	360
RGB LED Floodlights	361
LED Security Spotlights	362 - 363
LED Security Floodlight with PIR, Light Sensor, CCT, and Manual Override	364 - 365
Outdoor Heaters	366

Note: Some of our outdoor products may not be suitable for use in coastal areas where salt corrosion is prevalent



EASY-FIX PIR AND MICROWAVE ACCESSORIES



Angled bracket
for easy installation



Easy install
built-in connector



LOW PROFILE DESIGN



FLN10



FLN20



FLN30



FLN50

LIGHTWEIGHT LED FLOODLIGHTS

- This new range of LED floodlights offers the user quality and versatility, with the ability to add either PIR or Microwave Sensors
- High lumen - produces in excess of 105lm per watt
- Easy-install - with angled brackets and built-in connector, meaning no outdoor connections and faster installations

Construction: Die-cast aluminium

Lamp type: LED



Code	Wattage	Colour	CCT	Height	Width	Projection	Lumens
FLN10	10W	Cool White	4000K	70mm	95mm	29mm	1050lm
FLN20	20W	Cool White	4000K	95mm	135mm	29mm	2100lm
FLN30	30W	Cool White	4000K	110mm	160mm	29mm	3150lm
FLN50	50W	Cool White	4000K	145mm	200mm	29mm	5250lm



FLN FLOODLIGHT ACCESSORIES

Code	Model
FLNPIR	PIR Accessory
FLNMIC	Microwave Accessory



UP TO
18400
LUMENS



HIGH POWER LED FLOODLIGHTS

LED floodlights with high lumen output and instant ignition makes this luminaire ideal for security / high level illumination in commercial, retail, and industrial environments

- Internal terminal block on the rear allows for direct wiring
- Energy efficient low maintenance with high output
- Fortified bracket and fastenings



Construction: Die-cast aluminium
Driver: Integral
Lamp type: LED



Code	Wattage	Colour	CCT	Height	Width	Projection	Lumens
FLP100	100W	Cool White	4000K	205mm	300mm	60mm	8400lm
FLP100A	100W	Daylight	6000K	205mm	300mm	60mm	9200lm
FLP150	150W	Cool White	4000K	237mm	360mm	73mm	13500lm
FLP150A	150W	Daylight	6000K	237mm	360mm	73mm	14100lm
FLP200	200W	Cool White	4000K	237mm	360mm	73mm	17150lm
FLP200A	200W	Daylight	6000K	237mm	360mm	73mm	18400lm



RGB LED FLOODLIGHTS

- Colour changing LED floodlights
- RGB controller included

Construction: Die-cast aluminium

Driver: Integral

Lamp type: LED



Code	Wattage	Finish	Colour	Height	Width	Projection
FLF10RGB	10W	Black	RGB	90mm	130mm	30mm
FLF20RGB	20W	Black	RGB	126mm	180mm	30mm
FLF30RGB	30W	Black	RGB	147mm	210mm	37mm
FLF50RGB	50W	Black	RGB	182mm	260mm	41mm



LED SECURITY SPOTLIGHTS WITH PIR

- Adjustable die-cast aluminium head and polycarbonate body
- Cree LED
- Instant ignition
- Easy-fix mounting for simple installation
- Integral 180° PIR sensor with adjustable lux and time settings - 10m detection range (approx.)

Construction: Die-cast aluminium & polycarbonate

Driver: Integral

Lamp type: CoB LED

PIR field of detection: 180°



Code	Wattage	Finish	CCT	Height	Width	Projection	Lumens
FL8BK	8W	Black	5000K	176mm	78mm	107mm	610lm
FL8W	8W	White	5000K	176mm	78mm	107mm	610lm
FL16BK	2 x 8W	Black	5000K	176mm	141mm	113mm	1100lm
FL16W	2 x 8W	White	5000K	176mm	141mm	113mm	1100lm



TWIN SPOT SECURITY FLOODLIGHTS

- 2 x 9W LED
- Individual adjustable heads
- Long life and low-maintenance
- Ideal for outdoor applications; domestic, retail, and commercial use

PIR version:

- Illuminates for a fixed period of 90 seconds - illumination is constant whilst movement is detected
- Manual override facility
- Maximum detection distance approx. 8 metres

Construction: Die-cast aluminium

Driver: Integral

Lamp type: LED

PIR field of detection: 120°

230V
50Hz

IP65



Code	Model	Wattage	CCT	Height	Width	Projection	Lumens
FLTB	Black	2 x 9W	3500K	104mm	165mm	150mm	1300lm
FLTW	White	2 x 9W	3500K	104mm	165mm	150mm	1300lm
FLTPB	Black with PIR	2 x 9W	3500K	120mm	165mm	150mm	1300lm
FLTPW	White with PIR	2 x 9W	3500K	120mm	165mm	150mm	1300lm



Featuring user definable white light (3000K, 4000K, 5000K) by means of a selection switch



360° lamp bracket rotation, 180° lamp head rotation, 270° lamp head tilt



Fully featured built-in PIR with combined lux sensor providing accurate presence detection which can be overridden by a quick switch toggle, forcing the light into an *always on* state, removing the need for complex multi-core cables and switching arrangements



SL30CCTB



SL30CCTW



SL20CCTB



SL20CCTW

SECURITY FLOODLIGHT WITH PIR, LIGHT SENSOR, 3 X CCT & MANUAL OVERRIDE

- Wide operating voltage range 100-277Vac
- Twin or triple head options available (20W & 30W)
- High quality SMD2835 LEDs
- Manual override by toggling of power switch
- Adjustable sensitivity, time, and lux dials
- Simple mounting bracket with push-to-fit assembly
- 150° / 270° PIR detection range
- 10m detection distance

Construction: Polycarbonate

Driver: Integral

Lamp type: LED

Beam angle: 110° (from each head)

230V
50Hz

IP65



Code	Wattage	Finish	CCT	Height	Width	Base ø	Lumens	
SL20CCTB	20W	Black	CCT Adjustable	173mm	243mm	107mm	1810lm	NEW
SL20CCTW	20W	White	CCT Adjustable	173mm	243mm	107mm	1810lm	NEW
SL30CCTB	30W	Black	CCT Adjustable	190mm	222mm	107mm	2960lm	NEW
SL30CCTW	30W	White	CCT Adjustable	190mm	222mm	107mm	2960lm	NEW



Pole not included

INFRARED HEATERS

- Pre-wired with 3m cable
- Wall and pole bracket supplied

Construction: Die-cast aluminium

Driver: Not required

Lamp type: R7s

Height	Length	Depth	(mm)
245	345	179	

Code	Wattage	Model
HEOD1309BK	1300W	Black
HEOD1309W	1300W	White
HEOT1300W	1300W	254mm 1300W R7s Double Ended Lamp

230V
50Hz

IP24





KEEP UP TO DATE WITH NEW PRODUCTS, SPECIAL OFFERS, AND MORE



Knightsbridge



@KnightsbridgeML



@Knightsbridgema



@Knightsbridge



@Knightsbridgema



COMMERCIAL LIGHTING

BULKHEADS & WALL PACKS

These luminaires provide a high lumen output, long life and low running costs. Bulkheads can be wall or ceiling mounted, making them an efficient and versatile lighting option

CCT Adjustable LED Bulkheads & Accessories	370 - 373
LED Bulkheads	374
Polo LED Bulkheads / Round LED Bulkheads	375
LED Halo Bulkheads / LED Gear Trays	376 - 377
IK10 CCT Adjustable LED Bulkheads	378 - 379
LED Amenity Wall Packs	380
E27 and B22 Amenity Bulkheads	381
CCT Adjustable LED Wall Pack	382



IP65

FIND THE PERFECT FIT FOR ANY APPLICATION

Choice of trim finishes, with simple push-fit design

CCT ADJUSTABLE LED BULKHEAD

This versatile IP65 LED bulkhead boasts LED colour changing technology enabling the installer / end-user to adjust the colour temperature via a switch on the gear tray.

- Time saving and user-friendly installation via hinged gear tray and push-fit terminal block
- Specialised polycarbonate diffuser ensures high lumen levels with smooth uninterrupted light
- Suitable for domestic and commercial applications, wall or ceiling mounted
- A range of easy-fit coloured trims and eyelid options make this an extremely adaptable and time-saving solution
- Trim and eyelid options are manufactured from polycarbonate and easy to fix via simple push-fit design
- Supplied with black or chrome bezel





EASY INSTALL

PUSH-FIT TERMINAL BLOCK AND HINGED GEAR TRAY, FOR HASSLE-FREE WIRING



3 SIZES & 3 COLOUR TEMPERATURES



MULTI-FUNCTIONAL

9W



3000K

4000K

5700K

14W



3000K

4000K

5700K

20W



3000K

4000K

5700K



9W CCT ADJUSTABLE LED BULKHEAD

- CCT adjustable to 3000K, 665lm / 4000K, 760lm / 5700K, 700lm



Overall Ø	Projection	(mm)
256	74	

Code	Wattage	Model	Colour	CCT
BT9CT	9W	Standard	CCT	3000/4000/5700K
BT9CTEM	9W	Emergency	CCT	3000/4000/5700K
BT9CTS	9W	Sensor	CCT	3000/4000/5700K
BT9CTEMS	9W	Emergency and Sensor	CCT	3000/4000/5700K

14W CCT ADJUSTABLE LED BULKHEAD

- CCT adjustable to 3000K, 1085lm / 4000K, 1285lm / 5700K, 1130lm



Overall Ø	Projection	(mm)
315	74	

Code	Wattage	Model	Colour	CCT
BT14CT	14W	Standard	CCT	3000/4000/5700K
BT14CTEM	14W	Emergency	CCT	3000/4000/5700K
BT14CTS	14W	Sensor	CCT	3000/4000/5700K
BT14CTEMS	14W	Emergency and Sensor	CCT	3000/4000/5700K
BT14CTA	14W	Sensor (Corridor Function)	CCT	3000/4000/5700K
BT14CTEMA	14W	Emergency and Sensor (Corridor Function)	CCT	3000/4000/5700K

20W CCT ADJUSTABLE LED BULKHEAD

- CCT adjustable to 3000K, 1530lm / 4000K, 1760lm / 5700K, 1640lm



Overall Ø	Projection	(mm)
380	81	

Code	Wattage	Model	Colour	CCT
BT20CT	20W	Standard	CCT	3000/4000/5700K
BT20CTEM	20W	Emergency	CCT	3000/4000/5700K
BT20CTS	20W	Sensor	CCT	3000/4000/5700K
BT20CTEMS	20W	Emergency and Sensor	CCT	3000/4000/5700K
BT20CTA	20W	Sensor (Corridor Function)	CCT	3000/4000/5700K
BT20CTEMA	20W	Emergency and Sensor (Corridor Function)	CCT	3000/4000/5700K

230V
50Hz

IP65



3
YEAR
WARRANTY





BT9 BEZELS

Code	Finish
BT9CHR	Chrome
BT9B	Black
BT9G	Grey
BT9MBR	Brass
BT9SLV	Matt Silver

BT14 BEZELS

Code	Finish
BT14CHR	Chrome
BT14B	Black
BT14G	Grey
BT14MBR	Brass
BT14SLV	Matt Silver

BT20 BEZELS

Code	Finish
BT20CHR	Chrome
BT20B	Black
BT20G	Grey
BT20MBR	Brass
BT20SLV	Matt Silver



BT9 EYELIDS

Code	Finish
BT9EB	Black
BT9EG	Grey
BT9ES	Silver

BT14 EYELIDS

Code	Finish
BT14EB	Black
BT14EG	Grey
BT14ES	Silver





- Constructed from robust polycarbonate, ideal for commercial and domestic use
- Complete with hinged gear tray for easy installation
- Available in standard, microwave sensor, and emergency options

12W/20W LED BULKHEADS

Construction: Polycarbonate

Lamp type: LED

Overall Ø	Projection	(mm)
305	84 (12W)	
400	96 (20W)	

230V
50Hz

IP54



3
YEAR
WARRANTY



Code	Wattage	Model	Colour	CCT	Lumens
BL12LED	12W	Standard	Cool White	4000K	1000lm
BL20LED	20W	Standard	Cool White	4000K	1600lm
BL12LEDE	12W	Emergency	Cool White	4000K	1000lm
BL20LEDE	20W	Emergency	Cool White	4000K	1600lm
BL12LEDS	12W	Sensor	Cool White	4000K	1000lm
BL20LEDS	20W	Sensor	Cool White	4000K	1600lm

14W POLO LED BULKHEADS

- Features include a specially designed diffuser to ensure optimum lumen output
- Energy efficient and cool running
- Suitable for commercial and domestic applications



Construction: Polycarbonate

Lamp type: LED

Overall Ø	Projection	(mm)
330	110	



Code	Wattage	Model	Colour	CCT	Lumens
TPB14LED	14W	Standard	Daylight	6000K	1070lm
TPB14EMLED	14W	Emergency	Daylight	6000K	1070lm
TPB14SLED	14W	Sensor	Daylight	6000K	1070lm
TPB14EMSLED	14W	Emergency and Sensor	Daylight	6000K	1070lm
TPB14LEDA	14W	Sensor (Corridor Function)	Daylight	6000K	1070lm

TPB TRIMS



Code	Finish
TPB33BRRG	Brass
TPB33CHRG	Chrome



14W ROUND LED BULKHEAD

- Lightweight robust polycarbonate body
- Hinged gear tray for easy wiring and maintenance
- Comparable luminaire lumen output to 28W 2D fluorescent lamp



Construction: Polycarbonate

Lamp type: LED

Overall Ø	Projection	(mm)
285	86	



Code	Model	Wattage	Colour	CCT	Lumens
TPR14LED	Standard	14W	Cool White	4000K	1100lm
TPR14LEDA	Sensor (Corridor Function)	14W	Cool White	4000K	1100lm
TPR14LEDEM	Emergency	14W	Cool White	4000K	1100lm
TPR14LEDS	Sensor	14W	Cool White	4000K	1100lm



HALO BULKHEADS

- Low profile design with a range of bezels available to create an ambient halo backwash effect
- Supplied with 6000K LED tray as standard, alternative 4000K tray available

Construction: Polycarbonate & acrylic

Lamp type: LED



14W LED HALO BULKHEADS

Overall Ø	Projection	(mm)
291	97	

Code	Wattage	Model	Colour	CCT	Lumens
BF1430	14W	Standard	Daylight	6000K	1020lm
BF1430EM	14W	Emergency	Daylight	6000K	1020lm
BF1430S	14W	Sensor	Daylight	6000K	1020lm
BF1430EMS	14W	Emergency and Sensor	Daylight	6000K	1020lm
BF14L4K	14W	Cool White Gear Tray	Cool White	4000K	-

24W LED HALO BULKHEADS

Overall Ø	Projection	(mm)
318	117	

Code	Wattage	Model	Colour	CCT	Lumens
BF2440	24W	Standard	Daylight	6000K	1600lm
BF2440EM	24W	Emergency	Daylight	6000K	1600lm
BF2440S	24W	Sensor	Daylight	6000K	1600lm
BF2440EMS	24W	Emergency and Sensor	Daylight	6000K	1600lm
BF24L4K	24W	Cool White Gear Tray	Cool White	4000K	-



BF14 TRIMS



Code	Finish
BF14BBR	Matt Brass
BF14BCHR	Chrome
BF14BMS	Matt Silver
BF14BWHT	White

BF24 TRIMS



Code	Finish
BF24BBR	Matt Brass
BF24BCHR	Chrome
BF24BMS	Matt Silver
BF24BWHT	White



BPLED LED GEAR TRAYS

- Ideal replacement for traditional circular 2D 28W bulkheads
- Available with emergency function
- High SMD LED output and energy efficient

Construction: Cem-1

Driver: Included

Lamp type: SMD LED

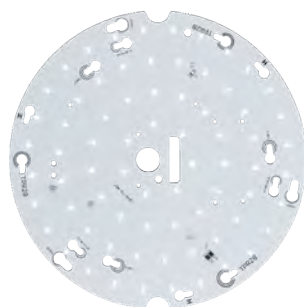

Overall Ø (mm)

246

Code	Wattage	Model	Colour	CCT	Lumens
BPLED	14W	Standard	Cool White	4000K	1400lm
BPLEDEM	14W	Emergency	Cool White	4000K	1400lm

**IK10****IMPACT
RESISTANCE
IK10**

A robust range of die-cast LED bulkheads. Features included are anti-vandal fixings CCT LED and high IK rating. Ideal for a wide range of environments

- CCT adjustable
- Low energy, low maintenance
- Standard and eyelid designs available

18W CCT ADJUSTABLE LED BULKHEAD

Construction: Die-cast aluminium

Lamp type: LED

Overall Ø	Projection	(mm)
360	92	



ANTI-VANDAL
DIFFUSER AND FIXINGS

IK10**230V
50Hz****IP65****5
YEAR
WARRANTY**

Code	Wattage	Model	Finish	CCT	Lumens
SHE1B	18W	Standard	Black	3000/4000/6000K	1680/1790/1810lm
SHE1BEM	18W	Emergency	Black	3000/4000/6000K	1680/1790/1810lm
SHE1BEMP	18W	Emergency + Daylight Sensor	Black	3000/4000/6000K	1680/1790/1810lm
SHE1BEMS	18W	Emergency + Microwave Sensor	Black	3000/4000/6000K	1680/1790/1810lm
SHE1BP	18W	Daylight Sensor	Black	3000/4000/6000K	1680/1790/1810lm
SHE1BS	18W	Microwave Sensor	Black	3000/4000/6000K	1680/1790/1810lm
SHE1G	18W	Standard	Grey	3000/4000/6000K	1680/1790/1810lm
SHE1GEM	18W	Emergency	Grey	3000/4000/6000K	1680/1790/1810lm
SHE1GEMP	18W	Emergency + Daylight Sensor	Grey	3000/4000/6000K	1680/1790/1810lm
SHE1GEMS	18W	Emergency + Microwave Sensor	Grey	3000/4000/6000K	1680/1790/1810lm
SHE1GP	18W	Daylight Sensor	Grey	3000/4000/6000K	1680/1790/1810lm
SHE1GS	18W	Microwave Sensor	Grey	3000/4000/6000K	1680/1790/1810lm



ANTI-VANDAL
DIFFUSER AND FIXINGS

18W CCT ADJUSTABLE LED EYELID BULKHEAD

Construction: Die-cast aluminium
Lamp type: LED

IK10

230V
50Hz

IP65



5
YEAR
WARRANTY

Overall Ø	Projection	(mm)
360	94	

Code	Wattage	Model	Finish	CCT	Lumens
SHE2B	18W	Standard	Black	3000/4000/6000K	1020/1080/1090lm
SHE2BEM	18W	Emergency	Black	3000/4000/6000K	1020/1080/1090lm
SHE2BEMP	18W	Emergency + Daylight Sensor	Black	3000/4000/6000K	1020/1080/1090lm
SHE2BEMS	18W	Emergency + Microwave Sensor	Black	3000/4000/6000K	1020/1080/1090lm
SHE2BP	18W	Daylight Sensor	Black	3000/4000/6000K	1020/1080/1090lm
SHE2BS	18W	Microwave Sensor	Black	3000/4000/6000K	1020/1080/1090lm
SHE2G	18W	Standard	Grey	3000/4000/6000K	1020/1080/1090lm
SHE2GEM	18W	Emergency	Grey	3000/4000/6000K	1020/1080/1090lm
SHE2GEMP	18W	Emergency + Daylight Sensor	Grey	3000/4000/6000K	1020/1080/1090lm
SHE2GEMS	18W	Emergency + Microwave Sensor	Grey	3000/4000/6000K	1020/1080/1090lm
SHE2GP	18W	Daylight Sensor	Grey	3000/4000/6000K	1020/1080/1090lm
SHE2GS	18W	Microwave Sensor	Grey	3000/4000/6000K	1020/1080/1090lm



LED AMENITY WALL PACKS

Construction: Polycarbonate

Driver: Integral

Lamp type: LED

Width	Length	Projection (mm)
108	197	78

Code	Wattage	Model	Colour	CCT	Lumens	
AMLEDB	5W	White / Black Base	Cool White	4000K	440lm	
AMLEDBS	5W	White / Black Base with Sensor	Cool White	4000K	410lm	
AMLEDBP	5W	White / Black Base with Daylight Sensor	Cool White	4000K	460lm	NEW
AMLEDR	5W	Red / Black Base	Red	-	-	
AMLEDW	5W	White / White Base	Cool White	4000K	460lm	
AMLEDWS	5W	White / White Base with Sensor	Cool White	4000K	410lm	
AMLEDWP	5W	White / White Base with Daylight Sensor	Cool White	4000K	460lm	NEW

230V 50Hz	IP54			3 YEAR WARRANTY	
--------------	------	--	--	-----------------------	--

E27 AMENITY BULKHEADS

Construction: Aluminium & polycarbonate

Lamp type: E27 (100W Max.)

Width	Length	Projection	(mm)
105	240	110	

Code	Model
E27PC	Prismatic Diffuser
E27PR	Red Diffuser



B22 AMENITY BULKHEADS

Construction: Aluminium & polycarbonate

Lamp type: B22d (BH22BC - 100W Max. / BH22PB - 60W Max.)

Width	Length	Projection	(mm)
124	244	120	

Code	Model
BH22BC	Aluminium Trim (Class I)
BH22PB	Black Polycarbonate Trim (Class II)



E27 DOME BULKHEADS

Construction: Aluminium & glass

Lamp type: E27 (60W Max.)

Height	Width	Projection (mm)
210	100	110

Code	Model
TPOV60B	Black
TPOV60W	White





15W CCT ADJUSTABLE WALL PACK WITH SENSOR

Construction: Die-cast aluminium

Driver: Integral

Lamp type: LED

Height	Width	Projection	(mm)
218	147	78	

Code	Wattage	Model	Colour	CCT	Lumens
WP15CTP	15W	Daylight Sensor	CCT Adjustable	3000/4000/5000K	1790/1835/1955lm



ABOUT THE CHANGES TO ENERGY RATING LABELS THIS YEAR

Two regulations, which become effective in the UK on September 1st 2021, will change the way lighting energy efficiency is assessed and labelled, as well as the quality of light output of LED lamps and luminaires.

We are all familiar with the rainbow colour labelling scheme which gives a broad indication of the energy efficiency of a product. The Energy Labelling Regulation (ELR) introduced new technical parameters to determine this energy efficiency, so that the ratings are not like-for-like replacements for the previous scheme. As a result, even previously top-rated products achieving A++ (the maximum for lighting) are now likely to come in at anywhere from C to G.

This doesn't mean that products previously rated A++ perform poorly for having a lower rating, just that the criteria for assessment has changed. You may have already seen this with white goods – such as fridge freezers – where online retailers are displaying labels from the old and new schemes together until we get used to the new one.

For lighting, there is an 18-month transition period applying which means that existing stocks with the old labels can be sold and displayed side-by-side with new items. From March 1st 2023, all products must display the new labels only.

However, many low-quality budget products won't achieve even a G rating and will have to be removed from sale, improving the overall average performance and energy efficiency of goods on the market.

All light sources with an energy label will have a QR code which will direct you to the 'EPREL' register, where more detailed information about the product and its efficiency can be obtained. This can also be used for verification of compliance.

The new Single Lighting Regulation (SLR) relates to 'light sources'* and stipulates certain performance criteria in terms of light output e.g. colour rendering, flicker, stroboscopic effect etc.

This more stringent focus on light performance will also see cheaper items removed from the market as upgrading them will be uneconomic, while certain types of lamp – such as compact fluorescents and most halogens, for instance – will effectively be phased out from September as they fail to meet the new criteria.

The SLR also places an obligation on manufacturers to improve the replaceability of component parts within luminaires, including a clear labelling scheme to specify which parts can be replaced by the end user or by a professional.

For peace of mind, you can rest assured that all lighting products from Knightsbridge comply with both the new ELR and SLR regulations.

*For the purposes of the SLR, a 'light source' is defined as either a traditional or modern lamp, or a luminaire that cannot be dismantled without damaging it.

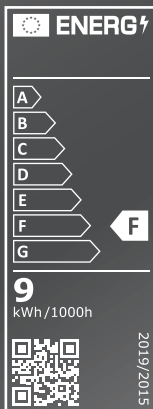
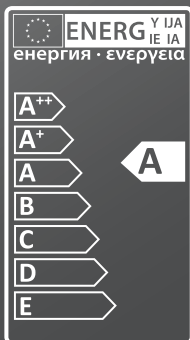





COMMERCIAL LIGHTING COMMERCIAL DOWNLIGHTS

These discreet, modern downlights are perfect for office, retail and other commercial spaces. This range includes the extremely versatile CPL LED Panel Downlights

Recess/Surface CCT Adjustable LED Panel Downlights

386 - 389

LED Downlights / LED Wallwashers

390 - 391

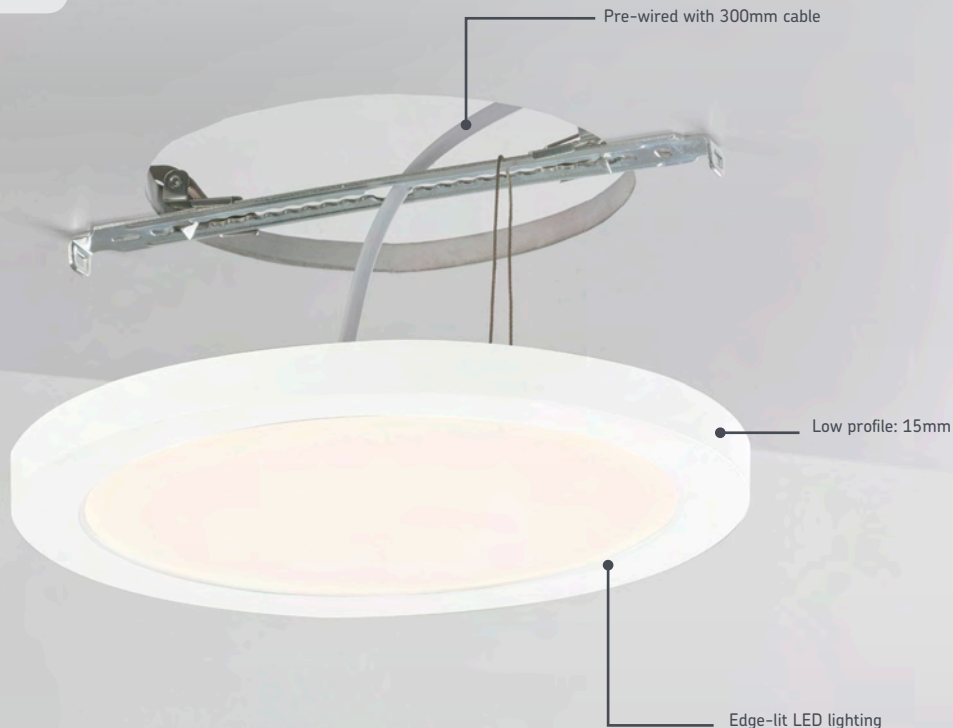

RECESS / SURFACE CCT ADJUSTABLE LED PANEL DOWNLIGHTS

This innovative dual mounting LED Panel is the ideal replacement for recessed traditional CFL / fluorescent downlights. Available in four sizes, the adjustable recessed fixings enable replacement for existing recessed light fixtures, and is easily adaptable for existing apertures of between 55mm - 250mm (subject to model). This ensures minimal redecoration and fast installation.

- Available in four sizes
- Pre-wired with 300mm cable
- Adjustable recessed brackets, suitable for 55mm to 250mm cut-out
- Edge-lit
- Optional magnetic bezels available

ADJUSTABLE MOUNTING BRACKET
55MM-250MM CUT-OUT

Construction: Polycarbonate
Driver: Integral
Lamp type: LED

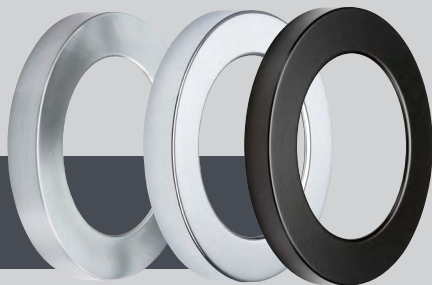

EASY-FIT MAGNETIC BEZELS

Supplied with white bezel as standard

RECESS MOUNTED

SURFACE MOUNTED

WALL MOUNTABLE



CCT ADJUSTABLE

LOCK CCT ON REAR OF PRODUCT, OR MAKE CCT ADJUSTABLE VIA WALL SWITCH

3000K

4000K

6000K



6W LED PANEL DOWNLIGHT

- CCT adjustable to 3000K, 400lm / 4000K, 430lm
6000K, 410lm

Overall Ø	Min. Void	Min./Max. Cut-out (mm)
140	50	Min. 55 - Max. 100

Code	Wattage
CPL6CT	6W
CPL6BC	Brushed Chrome Bezel
CPL6PC	Polished Chrome Bezel
CPL6MB	Matt Black Bezel



12W LED PANEL DOWNLIGHT

- CCT adjustable to 3000K, 850lm / 4000K, 940lm
6000K, 920lm

Overall Ø	Min. Void	Min./Max. Cut-out (mm)
165	50	Min. 55 - Max. 125

Code	Wattage
CPL12CT	12W
CPL12BC	Brushed Chrome Bezel
CPL12PC	Polished Chrome Bezel
CPL12MB	Matt Black Bezel



18W LED PANEL DOWNLIGHT

- CCT adjustable to 3000K, 1300lm / 4000K, 1400lm / 6000K, 1360lm

Overall Ø	Min. Void	Min./Max. Cut-out (mm)
217	50	Min. 55 - Max. 175

Code	Wattage
CPL18CT	18W
CPL18BC	Brushed Chrome Bezel
CPL18PC	Polished Chrome Bezel
CPL18MB	Matt Black Bezel

24W LED PANEL DOWNLIGHT

- CCT adjustable to 3000K, 1940lm / 4000K, 2140lm / 6000K, 2100lm

Overall Ø	Min. Void	Min./Max. Cut-out (mm)
290	50	Min. 55 - Max. 250

Code	Wattage
CPL24CT	24W
CPL24BC	Brushed Chrome Bezel
CPL24PC	Polished Chrome Bezel
CPL24MB	Matt Black Bezel

CPL DOWNLIGHT EMERGENCY KIT

- Compatible with 6W / 12W / 18W / 24W CPL fittings
- Inverter and battery pack included
- Pre-wired with easy-fix connectors and LED charge indicator
- CPL luminaire not included

Construction: Polycarbonate

Length	Height	Width (mm)
211	24	34

Code	Model
CPLEM	3-Hour LED Emergency Pack



230V
50Hz

IP20

3
YEAR
WARRANTY



SMART MODELS

Works with Alexa and Hey Google. See page 212

Code	Wattage	Overall Ø	Min/Max Cut-out	Colour	Lumens
CPL18WCT	18W	217mm	55 - 175mm	CCT Adjustable ● ●	1100 - 1400lm
CPL24WCT	24W	290mm	55 - 250mm	CCT Adjustable ● ●	1700 - 2100lm

230V
50Hz

IP20

VIA APP
ONLY

LAMP
INCLUDED

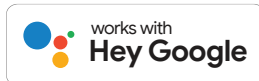

Amazon, Alexa and all related logos are trademarks of Amazon.com, Inc. or its affiliates.

Google is a trademark of Google LLC.



3000K

4200K

5700K

3 COLOUR SETTINGS

CCT change via switch on rear



LED CCT ADJUSTABLE DOWNLIGHT

Construction: Polycarbonate

Driver: Integral

Lamp type: LED

230V
50Hz

IP44



Cut-out Ø	Overall Ø	Minimum Void	Recessed Depth	(mm)
92	110	113	63	

Code	Wattage	CCT	Lumens
RDL9CCT	9W	3000/4200/5700K	800/880/850lm

LED ROUND RECESSED ADJUSTABLE DOWNLIGHTS

- Low power consumption when compared to classic CDM light source
- Reliable constant colour rendering and light output
- Low-maintenance and energy efficient providing cost savings
- Ideal for retail, office, and commercial applications

Construction: Aluminium

Driver: Included

Lamp type: LED

Tilt: 40°

Rotation: 350°



230V
50Hz

IP40



Cut-out Ø	Overall Ø	Minimum Void	Recessed Depth	(mm)
134	157	150	98	(15W)
160	190	172	122	(40W)

Code	Wattage	Colour	CCT	Lumens
WW15C	15W	Cool White	4000K	1400lm
WW40C	40W	Cool White	4000K	3650lm

CoB LED RECESSED DOWNLIGHTS

- Recessed dimmable LED fixtures with high lumen output
- Supplied with dimmable driver (please check dimmer compatibility)
- Ideal for commercial and retail environments

Construction: Aluminium & polycarbonate

Driver: Included

Lamp type: CoB LED



Minimum Void	Recessed Depth	(mm)
100	70	



Code	Wattage	Colour	CCT	Lumens	Overall Ø	Cut-out Ø
CRDL10	10W	Cool White	4000K	1080lm	135mm	125mm
CRDL15	15W	Cool White	4000K	1780lm	195mm	175mm
CRDL20	20W	Cool White	4000K	2430lm	195mm	175mm
CRDL30	30W	Cool White	4000K	3480lm	230mm	200mm

LED RECTANGULAR RECESSED WALLWASHERS

- Low power consumption when compared to classic CDM light source
- Reliable constant colour rendering and light output
- Low-maintenance and energy efficient providing cost savings
- Supplied complete with remote driver
- Ideal for retail, office, and commercial applications



Construction: Aluminium

Driver: Included

Lamp type: LED

Tilt: 60°



Length	Width	Minimum Void	Recessed Depth	Cut-out Dimensions	(mm)
240	157	135	85	222 x 125	

Code	Wattage	Colour	CCT	Lumens
WW30R	30W	Cool White	4000K	2800lm
WW40R	40W	Cool White	4000K	3650lm





COMMERCIAL LIGHTING

RECESSED, SURFACE, & SUSPENSION LIGHTING

Modular panels, surface-mounted and suspension lighting ideal for offices, retail, education, and a wide array of other commercial facilities

LED Recessed Modular Fittings	394
Tri-Mounting LED Panel	395
LED Surface Mounted Luminaire	396
Dual-Mount LED Luminaire	397
T8 Modular Fittings	398 - 399



LED RECESSED MODULAR FITTINGS

- An energy-efficient alternative to standard 4x18W fluorescent modular fittings
- Long-life, low maintenance
- Compatible with standard 600mm x 600mm 15mm and 25mm grids
- Instant ignition, ideal for external sensors

Construction: Steel

Driver: Included

Lamp type: LED

230V
50Hz

IP20



Width	Length	Recessed Depth	(mm)
595	595	52	

Code	Wattage	Colour	CCT	Lumens
MRBLED	32W	Cool White	4000K	3370lm
MRBLED6	32W	Daylight	6000K	3450lm

EMKIT2
emergency kit
See page 439





THREE MOUNTING OPTIONS

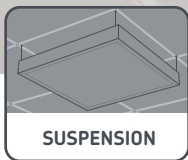
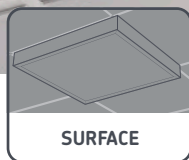

TRI-MOUNTING LED PANEL

- Ideal for commercial environments
- Ideal retrofit for all 595 x 595mm modules
- UGR19
- Low flicker
- Diffuser TP(a) rated
- Emergency conversion kit available (sold separately)
- Dimmable driver available

Construction: Aluminium / polycarbonate

Driver: Included

Lamp type: LED

Width	Length	Depth	(mm)
595	595	32	

230V
50Hz

IP20

LAMP
INCLUDED

3
YEAR
WARRANTY

Code	Wattage	Colour	CCT	Lumens	
LPAN30	30W	Cool White	4000K	3840lm	NEW

LPAN30 ACCESSORIES

Code	Model		Code	Model	
LPANKIT	Surface Mount Kit	NEW	LPAND	Constant Current Dimmable LED Driver	NEW
LPANRC	Recessed Clips	NEW	EMKIT2	Emergency Conversion Kit	
LPANS	Suspension Kit	NEW			



LED SURFACE MOUNTED LUMINAIRE

- Surface mounted high lumen LED luminaire
- Ideal for educational and nursing / care facilities, commercial, and retail environments

Construction: Polycarbonate

Driver: Included

Lamp type: LED

Width	Projection	(mm)
198	68	



Code	Wattage	Model	Length	Colour	CCT	Lumens
PRCLED	49W	Standard	1490mm	Cool White	4000K	6110lm
PRCLEDEM	49W	Emergency	1490mm	Cool White	4000K	6110lm
PRCLED4	43W	Standard	1229mm	Cool White	4000K	4700lm
PRCLEDEM4	43W	Emergency	1229mm	Cool White	4000K	4700lm



DUAL-MOUNT LED LUMINAIRE

Energy, time and cost-efficient lighting – made for the trade

Construction: Pressed steel

Diver: Included

Lamp type: LED

Easy to install surface or suspended, boasting quality and innovation offering superior flicker-free uniform illumination.

- Commercial grade 4790lm output
- Retrofit replacement for older fluorescent technology
- Surface and suspended mounting
- Compliant with latest Eco design and ErP requirements

- Push-fit terminals with loop-in / loop-out for easy wiring
- Low profile modern design
- Robust pressed steel and polycarbonate construction
- Works with various Knightsbridge motion and daylight sensors for added energy savings and maximised user comfort

Width	Length	Projection (mm)
200	1500	45

230V
50Hz

IP20

LAMP
INCLUDED

5
YEAR
WARRANTY

Code	Wattage	Model	Colour	CCT	Lumens	
SUR5LED	45W	Standard	Cool White	4000K	4790lm	NEW
SUR5LEDEM	45W	Emergency	Cool White	4000K	4790lm	NEW

Code	Description
5FTT5KIT	Suspension Fixing Kit



T8 RECESSED MODULAR FITTINGS (4 x 18W)

Construction: Steel
Lamp type: Fluorescent



Width	Length	Recessed Depth	(mm)
595	595	80	



Code	Wattage	Model
MRB418HF	72W	4 x 18W - Standard
MRB418EMHF	72W	4 x 18W - Emergency

FR600	Fire Hood (600mm x 600mm)
--------------	---------------------------



FR600

T8 RECESSED MODULAR FITTINGS (4 x 36W)

Construction: Steel
Lamp type: Fluorescent



Width	Length	Recessed Depth	(mm)
595	1195	86	



Code	Wattage	Model
MRA436HF	144W	4 x 36W - Standard
MRA436EMHF	144W	4 x 36W - Emergency

FR1200	Fire Hood (600mm x 1200mm)
---------------	----------------------------



FR1200



T8 SURFACE MOUNTED LUMINAIRE

Construction: Steel

Lamp type: Fluorescent

Projection (mm)

80

230V
50Hz

IP20



Code	Model	Width	Length
SURF236HF	2 x 36W T8	304mm	1220mm
SURF236EMHF	2 x 36W T8 - Emergency	304mm	1220mm
SURF258HF	2 x 58W T8	304mm	1520mm
SURF258EMHF	2 x 58W T8 - Emergency	304mm	1520mm
SURF270HF	2 x 70W T8	300mm	1785mm
SURF270EMHF	2 x 70W T8 - Emergency	300mm	1785mm

SUSPENSION KIT

Code	Model
5FTT5KIT	2m Suspension Kit

T8 MODULAR FLUORESCENT FITTINGS (4 x 18W)

Construction: Steel

Lamp type: Fluorescent

Width **Length** **Projection** (mm)

600 610 80

Code	Model
SURF418HF	4 x 18W T8
SURF418EMHF	4 x 18W T8 - Emergency



230V
50Hz

IP20





COMMERCIAL LIGHTING BATTENS

Our huge range of Battens provides a suitable product for any application. This includes innovative LED battens designed for quick and easy installations

T8 LED Tubes / T8 LED Battens	403
High Output LED Battens	404 - 405
LED Battens	406 - 407
LED CCT Adjustable Battens	408
LED Single Battens	409
T8 Fluorescent Battens / T8 Prismatic Diffusers / T8 Reflectors	410
T5 Fluorescent Battens / T5 Prismatic Diffusers	411



We're only a click away.

K-Direct is a quick and reliable home delivery service that provides next day delivery (across mainland UK) with a no-minimum order value or quantity. Simply place your customer's order online and have it delivered direct on your behalf. Cut out the time spent double handling and order exactly what you want without having to order minimum product quantities. Don't let logistics stand in the way of you and our fantastic products – order with K-Direct and ensure a professional, fast and efficient delivery service.

Our responsive website ensures, however you access our products, your experience is quick and hassle free.



**Quality products,
first class delivery**

-
- A quick and reliable home delivery service
 - Shipping direct to your customers on **YOUR** behalf
 - In excess of 3000 product lines in stock now
 - Quality which is not compromised, MLA is renowned for a 1st class customer service experience
 - No minimum box quantities*
 - No minimum order value
 - Reduces commitment to stock
 - No double handling
 - Next day delivery across mainland UK
 - Fast, efficient and professional
 - Created for our wholesalers to satisfy their customers

* Exceptions apply to fragile items

Place your customers order online and have it delivered direct on your behalf



T8 LED TUBES

- Alternative to classic T8 fluorescent lamps
- Up to 130lm/W
- Instant ignition provides uniform illumination
- Integral driver for ease of installation
- Not for use with external electronic or magnetic ballasts

230V
50Hz



Lamp type: LED

Code	Wattage	Construction	Colour	CCT	Length	Overall Ø	Lumens	Qty
T8LEDP9CW	9W	Glass	Cool White	4000K	603mm	27mm	1090lm	4
T8LEDP9DL	9W	Glass	Daylight	6000K	603mm	27mm	1080lm	4
T8LEDP18CW	18W	Glass	Cool White	4000K	1212mm	27mm	2295lm	4
T8LEDP18DL	18W	Glass	Daylight	6000K	1212mm	27mm	2230lm	4
T8LEDP24CW	24W	Glass	Cool White	4000K	1512mm	27mm	2980lm	4
T8LEDP24DL	24W	Glass	Daylight	6000K	1512mm	27mm	2895lm	4
T8LED6	30W	Polycarbonate	Cool White	4000K	1778mm	26mm	3350lm	1
T8LED6D	30W	Polycarbonate	Daylight	6000K	1778mm	26mm	3400lm	1

OS021
Batten Sensor
page 199



T8 LED BATTENS

- Supplied pre-wired for use with dedicated T8 LED self-ballasted tubes
- Supplied without a ballast (necessary for use with fluorescent lights)
- For use with LED tubes which are powered from one side only
- Manufactured in sizes to replace most standard traditional T8 fluorescent fixtures
- Tubes not included

Construction: Steel

Lamp type: LED

230V
50Hz

IP20



Code	Model	Width	Length	Projection	Qty
T8LB14	Single (4ft)	63mm	1225mm	80mm	4
T8LB15	Single (5ft)	63mm	1525mm	80mm	4
T8LB16	Single (6ft)	63mm	1778mm	80mm	4
T8LB24	Twin (4ft)	102mm	1225mm	86mm	4
T8LB25	Twin (5ft)	102mm	1525mm	86mm	4
T8LB26	Twin (6ft)	102mm	1778mm	86mm	4





HIGH OUTPUT LED BATTENS

- Dedicated non-replaceable LED light source
- Traditional T8 powder-coated steel body
- Purposely designed around the traditional T8 body to suit refurbishment projects with the appearance of a T8 batten
- Polycarbonate diffuser ensures strength and security resulting in minimal possibility of damage
- Virtually maintenance-free
- Ideal for replacement or as an alternative for T5/T8
- Perfect for indoor use in commercial, retail and domestic environments
- Compatible with external microwave and sensor controls

LED SINGLE BATTENS

Construction: Stainless steel

Driver: Integral

Lamp type: LED

Width	Projection	(mm)
60	85	

230V
50Hz

IP20

LAMP
INCLUDED

5
YEAR
WARRANTY

Code	Wattage	Model	Length	Colour	CCT	Lumens
T8BLED12	10W	(2ft) - Standard	615mm	Cool White	4000K	1200lm
T8BLED14	20W	(4ft) - Standard	1225mm	Cool White	4000K	2300lm
T8BLED15	26W	(5ft) - Standard	1525mm	Cool White	4000K	3000lm
T8BLED15EM1	26W	(5ft) - Emergency	1525mm	Cool White	4000K	3000lm
T8BLED16	30W	(6ft) - Standard	1790mm	Cool White	4000K	3450lm
T8BLED16EM1	30W	(6ft) - Emergency	1790mm	Cool White	4000K	3450lm





LED TWIN BATTENS

Construction: Stainless steel

Driver: Integral

Lamp type: LED

Width	Projection	(mm)
95	85	



Code	Wattage	Model	Length	Colour	CCT	Lumens
T8BLED22	20W	(2ft) - Standard	615mm	Cool White	4000K	2200lm
T8BLED24	40W	(4ft) - Standard	1225mm	Cool White	4000K	4500lm
T8BLED25	50W	(5ft) - Standard	1525mm	Cool White	4000K	5250lm
T8BLED25EM1	50W	(5ft) - Emergency	1525mm	Cool White	4000K	5250lm
T8BLED26	60W	(6ft) - Standard	1790mm	Cool White	4000K	6500lm
T8BLED26EM1	60W	(6ft) - Emergency	1790mm	Cool White	4000K	6500lm



LED BATTENS

- High efficiency - up to 120lm/W
- Rear and end conduit fixings
- Hinged gear tray and push-fit loop-in/loop-out connectors, for quick and easy installation
- Ideal replacement for most traditional fluorescent battens, including high lumen models that substitute traditional twin fittings

Construction: Pressed steel

Driver: Included

Lamp type: LED

Width	Projection	(mm)
61	71	

Code	Wattage	Model	Length	Colour	CCT	Lumens	
BATS2	12W	Standard	615mm	Cool White	4000K	1315lm	
BATS4	22W	Standard	1225mm	Cool White	4000K	2625lm	
BATS4EM	22W	Emergency	1225mm	Cool White	4000K	2625lm	
BATS4S	22W	Sensor	1225mm	Cool White	4000K	2625lm	
BATS5	37W	Standard	1525mm	Cool White	4000K	4290lm	
BATS5EM	37W	Emergency	1525mm	Cool White	4000K	4290lm	
BATS5S	37W	Sensor	1525mm	Cool White	4000K	4290lm	
BATS5EMS	37W	Sensor + Emergency	1525mm	Cool White	4000K	4290lm	
BATS5UHL	83W	Ultra High Lumen	1525mm	Cool White	4000K	11200lm	NEW
BATS5UHLEM	83W	Ultra High Lumen + Emergency	1525mm	Cool White	4000K	11200lm	NEW



Code	Wattage	Model	Length	Colour	CCT	Lumens	
BATS5H	55W	High Lumen	1525mm	Cool White	4000K	5925lm	
BATS5EMH	55W	High Lumen + Emergency	1525mm	Cool White	4000K	5925lm	
BATS6	42W	Standard	1790mm	Cool White	4000K	4875lm	
BATS6EM	42W	Emergency	1790mm	Cool White	4000K	4875lm	
BATS6S	42W	Sensor	1790mm	Cool White	4000K	4875lm	
BATS6EMS	42W	Sensor + Emergency	1790mm	Cool White	4000K	4875lm	
BATS6H	60W	High Lumen	1790mm	Cool White	4000K	6475lm	
BATS6EMH	60W	High Lumen + Emergency	1790mm	Cool White	4000K	6475lm	
BATS6UHL	100W	Ultra High Lumen	1790mm	Cool White	4000K	13500lm	NEW
BATS6UHLEM	100W	Ultra High Lumen + Emergency	1790mm	Cool White	4000K	13500lm	NEW



LED CCT ADJUSTABLE BATTENS

These LED Battens offer ultra high efficiency, with the latest CCT changing and LED Chip technology on-board, and convenience.

- Push-fit terminals with innovative hinged LED tray for ease of installation
- Options available include microwave sensor, emergency, and high lumen output
- Ideal replacement for old fluorescent fittings with retrofit fixing points

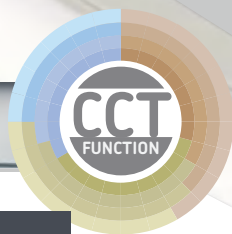

Construction: Steel & polycarbonate

Driver: Included

Lamp type: LED



Width	Projection	(mm)
61	71	



Code	Wattage	Model	Length	CCT	Lumens
BATC4	22W	Standard	1170mm	3000/4000/6000K	2545/2765/2745lm
BATC4EM	22W	Emergency	1170mm	3000/4000/6000K	2545/2765/2745lm
BATC5	35W	Standard	1470mm	3000/4000/6000K	3775/4160/4160lm
BATC5S	35W	Sensor	1470mm	3000/4000/6000K	3775/4160/4160lm
BATC5EM	35W	Emergency	1470mm	3000/4000/6000K	3775/4160/4160lm
BATC5H	60W	High Lumen	1470mm	3000/4000/6000K	6670/7440/7035lm
BATC5EMH	60W	High Lumen + Emergency	1470mm	3000/4000/6000K	6670/7440/7035lm
BATC6	40W	Standard	1734mm	3000/4000/6000K	4645/5045/4955lm
BATC6S	40W	Sensor	1734mm	3000/4000/6000K	4645/5045/4955lm
BATC6EM	40W	Emergency	1734mm	3000/4000/6000K	4645/5045/4955lm
BATC6H	67W	High Lumen	1734mm	3000/4000/6000K	7255/8100/7715lm
BATC6EMH	67W	High Lumen + Emergency	1734mm	3000/4000/6000K	7255/8100/7715lm



LED SINGLE BATTENS

- Double-insulated, lightweight, versatile, slimline design
- Simple installation via an easy-wire terminal box on the rear
- Alternative option to T5/T8 batten
- Ideal for commercial, retail, and domestic use in hallways, kitchens, and under cabinets

Construction: Aluminium & polycarbonate

Lamp type: LED

Width	Projection	(mm)
30	45	

Code	Wattage	Length	Colour	CCT	Lumens
LEDBAT9	9W	605mm	Cool White	4000K	900lm
LEDBAT17	17W	1220mm	Cool White	4000K	1800lm
LEDBAT22	22W	1520mm	Cool White	4000K	2400lm
LEDBAT26	25W	1768mm	Cool White	4000K	2700lm





T8 HF SINGLE FLUORESCENT BATTENS

- Supplied complete with high frequency control gear

Construction: Steel

Lamp type: Fluorescent



Width	Projection	(mm)
61	82	

Code	Model	Length	Qty
T8118HF	1 x 18W	617mm	4
T8136HF	1 x 36W	1227mm	4
T8136EMHF	1 x 36W - Emergency	1227mm	1
T8158HF	1 x 58W	1527mm	4
T8158EMHF	1 x 58W - Emergency	1527mm	1
T8170HF	1 x 70W	1791mm	4
T8170EMHF	1 x 70W - Emergency	1791mm	1



T8 HF TWIN FLUORESCENT BATTENS

Construction: Steel

Lamp type: Fluorescent



Width	Projection	(mm)
101	86	

Code	Model	Length	Qty
T8218HF	2 x 18W	617mm	4
T8236HF	2 x 36W	1227mm	4
T8236EMHF	2 x 36W - Emergency	1227mm	1
T8258HF	2 x 58W	1527mm	4
T8258EMHF	2 x 58W - Emergency	1527mm	1
T8270HF	2 x 70W	1791mm	4
T8270EMHF	2 x 70W - Emergency	1791mm	1



T8 PRISMATIC DIFFUSERS

Construction: Polycarbonate

Code	Model	Length	Qty
T8DIFF136	1 x 36W	4ft	2
T8DIFF158	1 x 58W	5ft	2
T8DIFF170	1 x 70W	6ft	2
T8DIFF236	2 x 36W	4ft	2
T8DIFF258	2 x 58W	5ft	2
T8DIFF270	2 x 70W	6ft	2



T8 REFLECTORS

Construction: Steel

Width	Projection	(mm)
150	45	

Code	Model	Length	Qty
T8REF36	Reflector for 36W	4ft	4
T8REF58	Reflector for 58W	5ft	4
T8REF70	Reflector for 70W	6ft	4

T5 HF SINGLE FLUORESCENT BATTENS

Construction: Steel

Lamp type: Fluorescent

Width	Projection	(mm)
63	82.5	

Code	Wattage	Model	Length	Qty
T5114	14W	1 x 14W	575mm	4
T5128	28W	1 x 28W	1175mm	4
T5128EM	28W	1 x 28W - Emergency	1175mm	1
T5135	35W	1 x 35W	1475mm	4
T5135EM	35W	1 x 35W - Emergency	1475mm	1
T5149	49W	1 x 49W	1475mm	4
T5149EM	49W	1 x 49W - Emergency	1475mm	1



T5 HF TWIN FLUORESCENT BATTENS

Construction: Steel

Lamp type: Fluorescent

Width	Projection	(mm)
63	83.5	

Code	Wattage	Model	Length	Qty
T5214	14W	2 x 14W	575mm	4
T5228	28W	2 x 28W	1175mm	4
T5228EM	28W	2 x 28W - Emergency	1175mm	1
T5235	35W	2 x 35W	1475mm	4
T5235EM	35W	2 x 35W - Emergency	1475mm	1
T5249	49W	2 x 49W	1475mm	4
T5249EM	49W	2 x 49W - Emergency	1475mm	1



T5 PRISMATIC DIFFUSERS

- Streamlined, anti-glare, polycarbonate prismatic diffuser
- Complete with end caps
- Diffuser fits single and twin fitting

Construction: Polycarbonate

Code	Model	Qty
T5DIF2	2ft	2
T5DIF4	4ft	2
T5DIF5	5ft	2





COMMERCIAL LIGHTING

NON-CORROSIVE & HIGH / LOW BAY

The Non-Corrosive range brings the benefits of standard batten luminaires into damp or corrosive atmospheres. High and Low Bay lighting offers effective high-lumen solutions for large industrial spaces, such as warehouses

Non-Corrosive

TorlanECO Fast-Fix LED Non-Corrosive Battens	415
Integral LED Non-Corrosive Fittings	416 - 417
T5 Non-Corrosive Fluorescent Fittings	418
230V & 110V T8 Non-Corrosive Fluorescent Fittings	419

High Bay / Low Bay

Dimmable LED Low Bay	421
LED High Bay and Accessories	422 - 423



HAVE A QUESTION? CHAT WITH OUR TEAM **INSTANTLY!**

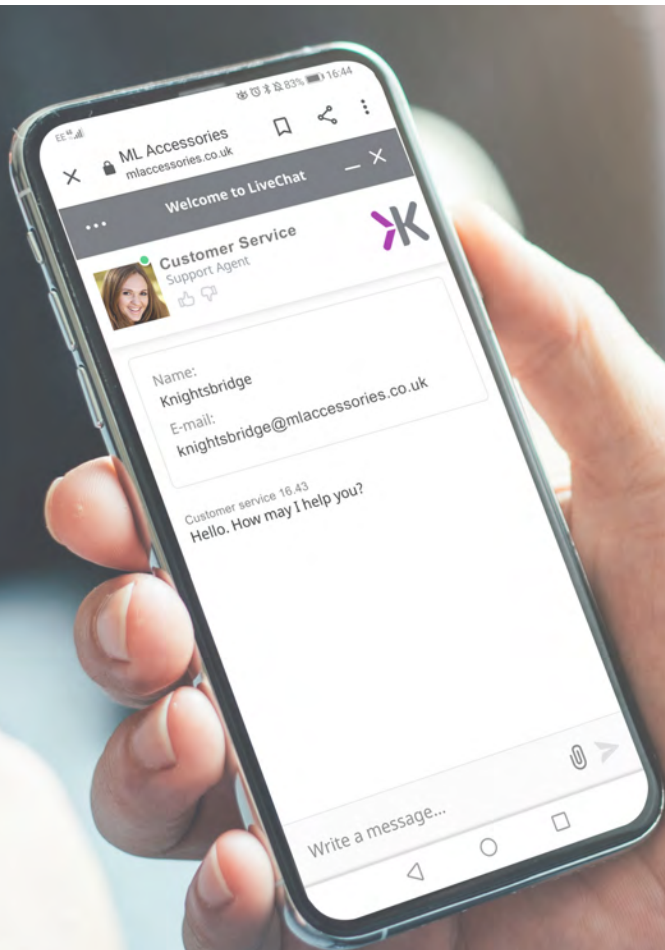

www.mlaccessories.co.uk

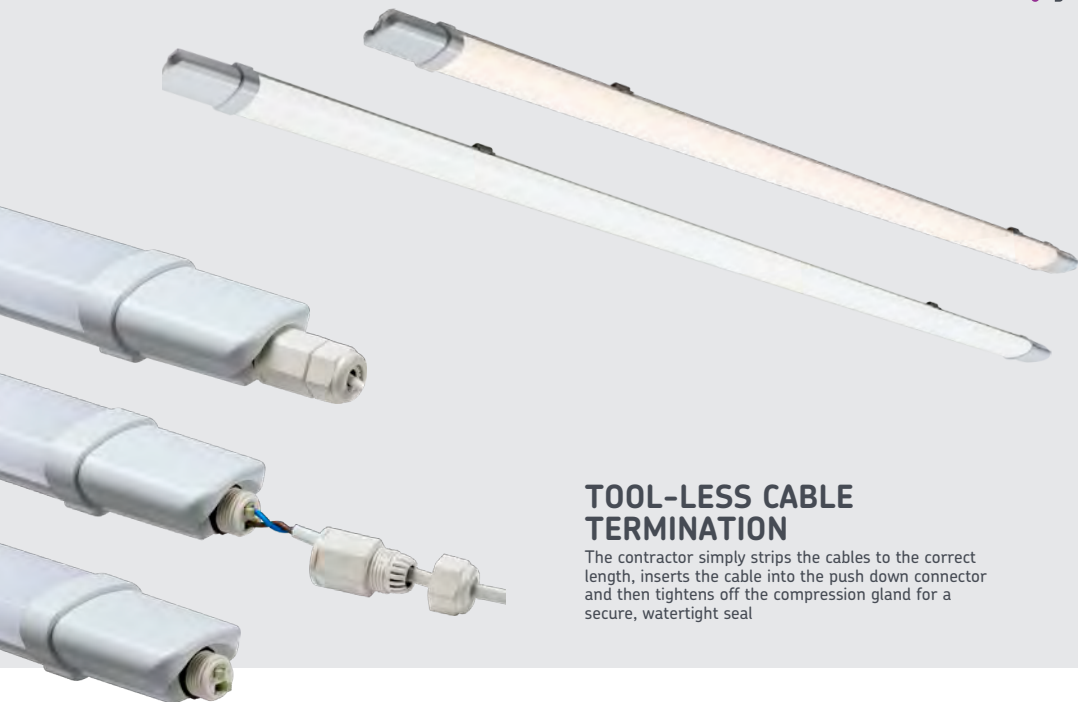

TOOL-LESS CABLE TERMINATION

The contractor simply strips the cables to the correct length, inserts the cable into the push down connector and then tightens off the compression gland for a secure, watertight seal

TorlanECO FAST-FIX LED NON-CORROSIVE BATTENS

The latest addition to our non-corrosive range. TorlanECO is a cost effective IP65 and IK06 rated LED batten fixture, designed for budget projects, that demand quality and superior uniform illumination.

- Easy-install: simply fix the bracket to the intended surface and push the fixture into place
- Wall and ceiling mountable
- Suitable for both indoor and outdoor applications, within residential and commercial premises

Construction: Polycarbonate
Driver: Integral
Lamp type: LED

Code	Wattage	Model	Length	Colour	CCT	Lumens	
TORE4K18	18W	3ft	700mm	Cool White	4000K	1790lm	NEW
TORE5K18	18W	3ft	700mm	Daylight	5700K	1800lm	NEW
TORE4K36	36W	4ft	1230mm	Cool White	4000K	3735lm	NEW
TORE5K36	36W	4ft	1230mm	Daylight	5700K	3710lm	NEW
TORE4K45	45W	5ft	1530mm	Cool White	4000K	4670lm	NEW
TORE5K45	45W	5ft	1530mm	Daylight	5700K	4585lm	NEW





0S021
Batten Sensor
page 199



INTEGRAL LED NON-CORROSIVE FITTINGS

INCLUDES 110V MODELS FOR SITE LIGHTING

- High output IP65 LED non-corrosive fittings
- Constructed from impact-resistant durable polycarbonate base and diffuser
- Fitting supplied with quick-fit connector and complete with fixing accessories
- Ideal replacement for standard fluorescent fixtures
- Optional stainless steel accessories available



INTEGRAL LED SINGLE NON-CORROSIVE FITTINGS

Construction: Polycarbonate
Driver: Integral
Lamp type: LED

Width	Projection	(mm)	230V 50Hz	IP65		 LAMP INCLUDED	5 YEAR WARRANTY		110V
94	90								

Code	Wattage	Model	Length	Colour	CCT	Lumens
TRLED12	14W	Single (2ft) - Standard	653mm	Cool White	4000K	1530lm
TRLED14	23W	Single (4ft) - Standard	1263mm	Cool White	4000K	2650lm
TRLED14EM	23W	Single (4ft) - Emergency	1263mm	Cool White	4000K	2650lm
TRLED15	29W	Single (5ft) - Standard	1563mm	Cool White	4000K	3650lm
TRLED151	29W	Single (5ft) - 110V	1563mm	Cool White	4000K	3400lm
TRLED151EM	29W	Single (5ft) - 110V Emergency	1563mm	Cool White	4000K	3400lm
TRLED15D	29W	Single (5ft) - Standard	1563mm	Daylight	6000K	3610lm
TRLED15EM	29W	Single (5ft) - Emergency	1563mm	Cool White	4000K	3650lm
TRLED15EMD	29W	Single (5ft) - Emergency	1563mm	Daylight	6000K	3610lm
TRLED16	33W	Single (6ft) - Standard	1828mm	Cool White	4000K	4100lm
TRLED16D	33W	Single (6ft) - Standard	1828mm	Daylight	6000K	3960lm
TRLED16EM	33W	Single (6ft) - Emergency	1828mm	Cool White	4000K	4100lm
TRLED16EMD	33W	Single (6ft) - Emergency	1828mm	Daylight	6000K	3960lm

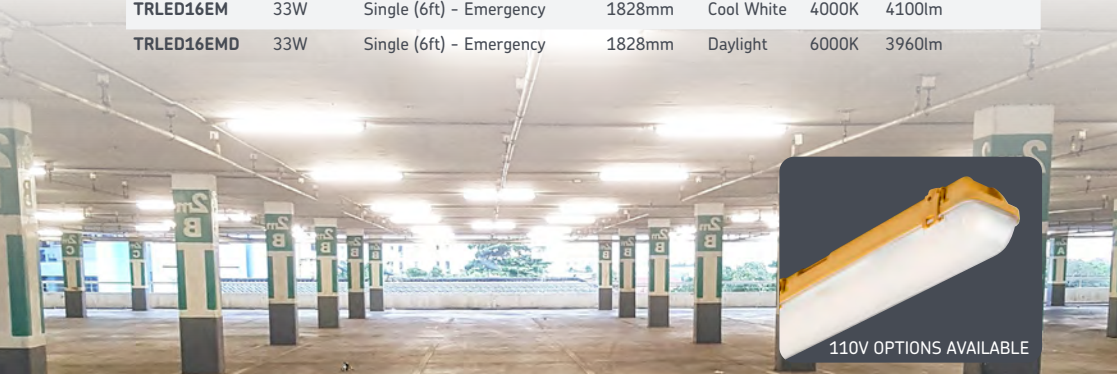

110V OPTIONS AVAILABLE



INTEGRAL LED TWIN NON-CORROSIVE FITTINGS

Construction: Polycarbonate

Driver: Integral

Lamp type: LED

Width	Projection	(mm)
129	90	



Code	Wattage	Model	Length	Colour	CCT	Lumens
TRLED22	28W	Twin (2ft) - Standard	653mm	Cool White	4000K	3050lm
TRLED221	28W	Twin (2ft) - 110V	653mm	Cool White	4000K	3000lm
TRLED221EM	28W	Twin (2ft) - 110V Emergency	653mm	Cool White	4000K	3000lm
TRLED24	41W	Twin (4ft) - Standard	1263mm	Cool White	4000K	4670lm
TRLED24EM	41W	Twin (4ft) - Emergency	1263mm	Cool White	4000K	4670lm
TRLED25	50W	Twin (5ft) - Standard	1563mm	Cool White	4000K	5800lm
TRLED25D	50W	Twin (5ft) - Standard	1563mm	Daylight	6000K	5700lm
TRLED25EM	50W	Twin (5ft) - Emergency	1563mm	Cool White	4000K	5800lm
TRLED25EMD	50W	Twin (5ft) - Emergency	1563mm	Daylight	6000K	5700lm
TRLED26	69W	Twin (6ft) - Standard	1828mm	Cool White	4000K	7770lm
TRLED26D	69W	Twin (6ft) - Standard	1828mm	Daylight	6000K	7820lm
TRLED26EM	69W	Twin (6ft) - Emergency	1828mm	Cool White	4000K	7770lm
TRLED26EMD	69W	Twin (6ft) - Emergency	1828mm	Daylight	6000K	7820lm

STAINLESS STEEL CLIPS

Code	Model	Qty
ACCLIP	Stainless Steel Clip	20





NON-CORROSIVE IP65 T5 AND T8 FLUORESCENT FITTINGS

- Manufactured from strong robust polycarbonate
- High output polycarbonate prismatic lens for optimum light output
- Min./max. operating temperatures: -15°C / +30°C
- Polycarbonate clips, fixing brackets and 20mm compression gland included
- Can be surface mounted or suspended with suspension eye
- Push-fit terminals for ease of installation

T5 HF SINGLE NON-CORROSIVE FLUORESCENT FITTINGS

Construction: Polycarbonate

Lamp type: T5

Width	Projection	(mm)
65	75	

Code	Model	Length
NC65128HF	1 x 28W (4ft) - Standard	1210mm
NC65135HF	1 x 35W (5ft) - Standard	1510mm
NC65135EMHF	1 x 35W (5ft) - Emergency	1510mm



OS021
Batten Sensor
page 199



230V
50Hz

IP65



T5 HF TWIN NON-CORROSIVE FLUORESCENT FITTINGS

Construction: Polycarbonate

Lamp type: T5

Width	Projection	(mm)
104	75	

Code	Model	Length
NC65228HF	2 x 28W (4ft) - Standard	1210mm
NC65235HF	2 x 35W (5ft) - Standard	1510mm
NC65235EMHF	2 x 35W (5ft) - Emergency	1510mm



230V
50Hz

IP65



STAINLESS STEEL CLIPS

- Optional stainless steel clips for T5 non-corrosive fittings

Code	Model	Qty
NCT5CLIP	Stainless Steel Clip	20





T8 HF SINGLE NON-CORROSIVE FLUORESCENT FITTINGS

Construction: Polycarbonate
Lamp type: T8

Width	Projection	(mm)
94	90	

Code	Model	Length
AC65118	1 x 18W (2ft) - Standard	653mm
AC65136	1 x 36W (4ft) - Standard	1263mm
AC65136EM	1 x 36W (4ft) - Emergency	1263mm
AC65158	1 x 58W (5ft) - Standard	1563mm
AC65158EM	1 x 58W (5ft) - Emergency	1563mm
AC65170	1 x 70W (6ft) - Standard	1828mm
AC65170EM	1 x 70W (6ft) - Emergency	1828mm

T8 HF TWIN NON-CORROSIVE FLUORESCENT FITTINGS

Construction: Polycarbonate
Lamp type: T8

Width	Projection	(mm)
129	90	

Code	Model	Length
AC65218	2 x 18W (2ft) - Standard	653mm
AC65236	2 x 36W (4ft) - Standard	1263mm
AC65236EM	2 x 36W (4ft) - Emergency	1263mm
AC65258	2 x 58W (5ft) - Standard	1563mm
AC65258EM	2 x 58W (5ft) - Emergency	1563mm
AC65270	2 x 70W (6ft) - Standard	1828mm
AC65270EM	2 x 70W (6ft) - Emergency	1828mm

110V T8 HF NON-CORROSIVE FLUORESCENT FITTINGS

Construction: Polycarbonate
Lamp type: T8



Model	Width	Projection	(mm)
Single	94	90	
Twin	129	90	

Code	Model	Length
AC651581	1 x 58W (5ft) - Standard	1563mm
AC651581EM	1 x 58W (5ft) - Emergency	1563mm
AC652581	2 x 58W (5ft) - Standard	1563mm
AC652581EM	2 x 58W (5ft) - Emergency	1563mm



STAINLESS STEEL CLIPS

- Optional stainless steel clips for T8 non-corrosive fittings

Code	Model	Qty
ACCLIP	Stainless Steel Clip	20



ABOUT THE CHANGES TO ENERGY RATING LABELS THIS YEAR

Two regulations, which become effective in the UK on September 1st 2021, will change the way lighting energy efficiency is assessed and labelled, as well as the quality of light output of LED lamps and luminaires.

We are all familiar with the rainbow colour labelling scheme which gives a broad indication of the energy efficiency of a product. The Energy Labelling Regulation (ELR) introduced new technical parameters to determine this energy efficiency, so that the ratings are not like-for-like replacements for the previous scheme. As a result, even previously top-rated products achieving A++ (the maximum for lighting) are now likely to come in at anywhere from C to G.

This doesn't mean that products previously rated A++ perform poorly for having a lower rating, just that the criteria for assessment has changed. You may have already seen this with white goods – such as fridge freezers – where online retailers are displaying labels from the old and new schemes together until we get used to the new one.

For lighting, there is an 18-month transition period applying which means that existing stocks with the old labels can be sold and displayed side-by-side with new items. From March 1st 2023, all products must display the new labels only.

However, many low-quality budget products won't achieve even a G rating and will have to be removed from sale, improving the overall average performance and energy efficiency of goods on the market.

All light sources with an energy label will have a QR code which will direct you to the 'EPREL' register, where more detailed information about the product and its efficiency can be obtained. This can also be used for verification of compliance.

The new Single Lighting Regulation (SLR) relates to 'light sources'* and stipulates certain performance criteria in terms of light output e.g. colour rendering, flicker, stroboscopic effect etc.

This more stringent focus on light performance will also see cheaper items removed from the market as upgrading them will be uneconomic, while certain types of lamp – such as compact fluorescents and most halogens, for instance – will effectively be phased out from September as they fail to meet the new criteria.

The SLR also places an obligation on manufacturers to improve the replaceability of component parts within luminaires, including a clear labelling scheme to specify which parts can be replaced by the end user or by a professional.

For peace of mind, you can rest assured that all lighting products from Knightsbridge comply with both the new ELR and SLR regulations.

*For the purposes of the SLR, a 'light source' is defined as either a traditional or modern lamp, or a luminaire that cannot be dismantled without damaging it.

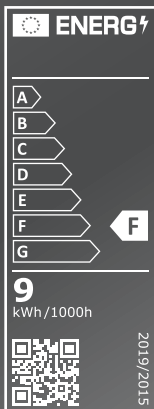
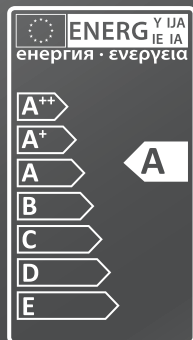

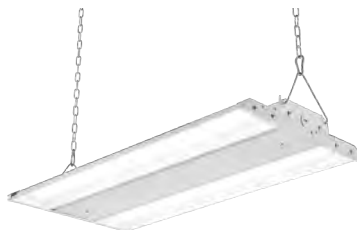
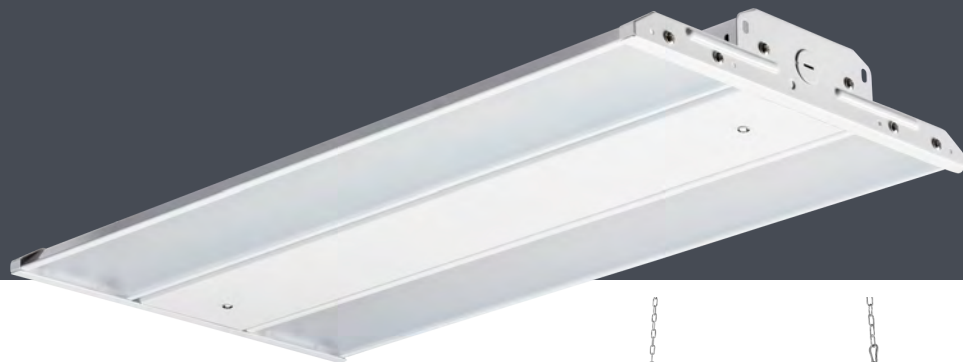

DIMMABLE LED LOW BAY

- Low profile
- Ideal for commercial and industrial lighting
- Supplied as standard with 0-10V dimmable driver (0-10V dimmer is required), and suspension hooks and chains
- Surface mount brackets, PIR sensor, and Microwave sensor available separately

Construction: Pressed steel

Driver: Integral

Lamp type: LED

Beam angle: 85°

HIGH LUMEN OUTPUT
(140lm/W)

Length	Width	Projection	(mm)
630	325	53	



Code	Wattage	Colour	CCT	Lumens	
LWB90	90W	Daylight	5500K	12800lm	NEW
LWB165	165W	Daylight	5500K	23220lm	NEW



LWBEMKIT



LWBPIR



LWBMOU



LWBMIC

Code	Model	
LWBEMKIT	Emergency Kit	NEW
LWBMIC	360° Microwave Dimming Sensor	NEW
LWBMOU	Surface Mount Brackets	NEW
LWBPIR	360° PIR Sensor	NEW



LED HIGH BAY

Our latest dimmable LED High Bay has an improved high LED lumen efficiency (130lm/W). Supplied with 1-10V dimmable driver (1-10V dimmer is required) and a suspension hook.

- Suspended or surface mountable
- High lumen output for indoor use

Construction: Aluminium

Driver: Integral

Lamp type: LED

Beam angle: 115°

230V
50Hz

IP65



Code	Wattage	Diameter	Projection	Colour	CCT	Lumens
HBN150	150W	298mm	193mm	Daylight	5500K	19800lm
HBN200	200W	360mm	215mm	Daylight	5500K	27000lm

LED HIGH BAY REFLECTOR

- Modifies HBN High Bay beam angle from 115° to 80°
- Simple installation (supplied with 4 3x12mm screws)

Projection: 153mm

Code	Model	Diameter
HBNR1	Reflector (for HBN150)	382mm
HBNR2	Reflector (for HBN200)	463mm



MICROWAVE DIMMING SENSOR

- Supplied with fixing bracket
- Simple to fix
- 1-10V dimming only
- 360° detection angle

Code	Model
HBN51	Microwave 1 - 10V Dimming Sensor



U-BRACKETS

Code	Model
HBLU1	U-Bracket for HB 150W High Bay LED
HBLU2	U-Bracket for HB 200W High Bay LED



EMERGENCY

A comprehensive range of emergency floodlights, bulkheads, exit signs, downlights and emergency kits, to help ensure a safe premises. The range includes products with self-test facilities

Emergency Floodlights	428 - 429
Emergency Bulkheads	430 - 431
Exit Signs & Legends	432 - 433
Suspended / Recessed / Dual-mounting Exit Signs	434 - 435
Emergency Downlights	436 - 438
Emergency Kits	439



Knightsbridge

SELF-TEST PRODUCTS



EMTWINST
SELF-TEST 2X3W LED EMERGENCY FLOODLIGHT



EMLED5
SELF-TEST 4W LED EMERGENCY BULKHEAD

SELF-TEST

AUTO
SELF-TEST

WHAT IS SELF-TEST?

The self-test feature is built into each product and conducts routine functional and duration testing in accordance with the relevant standards, obviating the need for costly manual testing and intervention other than to record and rectify faults.

WHAT ARE THE BENEFITS?

Self-test lighting offers convenience, compliance, cost savings, and ease of fault identification. With no requirement to isolate the mains supply to test, there is no disruption to the normal working day and no loss of productivity.

HOW DOES IT WORK?

After installation and an initial 24-hour charging period, the product conducts its own self-test operation. This comprises of a 3-hour duration test, after which a 30-second 'monthly' function test is carried out every 28 days, and then yearly another 3-hour duration test. Following each self-test sequence, the unit will revert into charging mode.

The unit's status and any fault modes are shown by the bi-colour LED indicator and manual initiation of the testing procedure is also possible should it be required.



EMXST
SELF-TEST 4W DUAL-MOUNTING LED EXIT SIGN

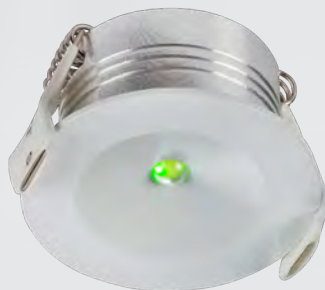

EMPOWERST
SELF-TEST 3W RECESSED LED EMERGENCY DOWNLIGHT



LED EMERGENCY FLOODLIGHT

- Robust lightweight polycarbonate case and spotlights
- High lumen output
- Suitable for non-maintained use only
- **EMTWINST ONLY:** self test facility in accordance with EN 62034

Construction: Polycarbonate

Lamp type: LED



AUTO
SELF-TEST

Height	Projection	Width	(mm)
301	90	280	

230V 50Hz	IP65			3 YEAR WARRANTY	
----------------------------	-------------	--	--	---------------------------	--

Code	Wattage	Model	Colour	CCT	Emergency Lumens
EMTWINIP	2 x 3W	3-hour	Daylight	6000K	490lm
EMTWINST	2 x 3W	Self-Test - 3-Hour	Daylight	6000K	490lm



LED EMERGENCY FLOODLIGHT

- Constructed from durable lightweight polycarbonate
- Replacement for traditional twin halogen units
- Long life, high lumen, low-maintenance
- Suitable for non-maintained use only

Construction: Polycarbonate

Lamp type: LED

Height	Projection	Width	(mm)
270	70	273	



Code	Wattage	Model	Colour	CCT	Emergency Lumens
EMTWINPC	2 x 3W	3-Hour	Daylight	6500K	410lm

LED EMERGENCY FLOODLIGHT

- Replacement for traditional twin halogen units
- Long life, high lumens, low-maintenance
- Suitable for non-maintained use only

Construction: Polycarbonate

Lamp type: LED



Height	Projection	Width	(mm)
260	130	293	



Code	Wattage	Model	Colour	CCT	Emergency Lumens
EMTWIN	2 x 3W	3-Hour	Warm White	3000K	375lm

3W LED EMERGENCY BULKHEAD

- Hinged gear tray and push-fit connector for simple installation
- Complete with self-adhesive legend kit
- Suitable for maintained or non-maintained use

Construction: Polycarbonate

Lamp type: LED



Height	Projection	Length	(mm)
117	60	350	

230V
50Hz

IP65

LAMP INCLUDED

3
YEAR WARRANTY

Code	Wattage	Model	Colour	CCT	Lumens	Emergency Lumens
EMLED4	3W	3-Hour	Daylight	5500K	115lm	115lm

6W LED EMERGENCY BULKHEAD

- Hinged gear tray for ease of installation
- Legend kit included
- Suitable for maintained or non-maintained use

Construction: Polycarbonate

Lamp type: LED



Height	Projection	Length	(mm)
107	76	345	

230V
50Hz

IP65

LAMP INCLUDED

3
YEAR WARRANTY

Code	Wattage	Model	Colour	CCT	Lumens	Emergency Lumens
EMLED1	6W	3-Hour	Daylight	6500K	405lm	120lm

4W LED EMERGENCY BULKHEAD

- Hinged gear tray for ease of installation
- Legend kit included
- Suitable for maintained or non-maintained use

Construction: Polycarbonate

Lamp type: LED

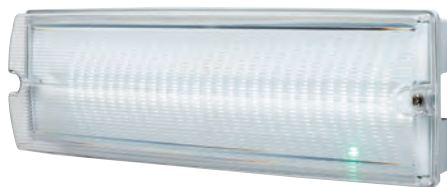

Height	Projection	Length	(mm)
110	60	351	

230V
50Hz

IP65

LAMP INCLUDED

3
YEAR WARRANTY

Code	Wattage	Model	Colour	CCT	Lumens	Emergency Lumens
EMLED3	4W	3-Hour	Daylight	6500K	160lm	100lm

3W COMPACT LED EMERGENCY BULKHEAD

- 40% smaller than the standard emergency luminaire
- Hinged gear tray for ease of installation
- Legend kit, opal and prismatic diffuser included
- Suitable for maintained or non-maintained use



Construction: Polycarbonate

Lamp type: LED

Height	Projection	Length	(mm)
97	48	216	



Code	Wattage	Model	Colour	CCT	Lumens	Emergency Lumens
EMLED2A	3W	3-Hour	Daylight	6000K	150lm	115lm

4W LED EMERGENCY SELF-TEST BULKHEAD

- Self-test facility in accordance with EN 62034, ensuring periodic testing at pre-programmed intervals
- Suitable for maintained or non-maintained use
- Low maintenance

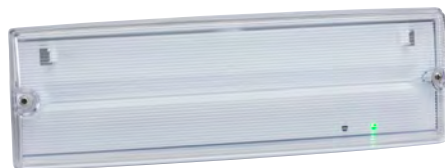

Construction: Polycarbonate

Lamp type: LED

Height	Projection	Length	(mm)
110	60	350	



Code	Wattage	Model	Colour	CCT	Lumens	Emergency Lumens
EMLED5	4W	Self-Test - 3-Hour	Daylight	6000K	150lm	135lm

**SELF-ADHESIVE LEGEND
KIT SUPPLIED WITH ALL
EMERGENCY BULKHEADS**



WALL MOUNTED LED EXIT SIGN AND LEGENDS

- Lightweight wall mounted metal frame with polycarbonate legends
- Supplied as standard with arrow up - alternative legends available
- Suitable for maintained or non-maintained use

Construction: Pressed steel

Lamp type: LED



Height	Projection	Width	(mm)
190	60	390	



Code	Wattage	Model	Colour	CCT	Lumens	Emergency Lumens
EMRUN	6W	3-Hour	Daylight	6000K	105lm	50lm

LEGENDS

- To fit EMEXIT, EMXST, EMLSUS and EMLREC

Code	Model
EMRUND	Down Legend
EMRUNL	Left Legend
EMRUNR	Right Legend
EMRUNU	Up Legend



WALL MOUNTED SELF-TEST EXIT SIGN AND LEGENDS

- Self-test facility in accordance with EN 62034
- Lightweight, durable polycarbonate with interchangeable legends
- Supplied with arrow up, alternative down and left/right legends included
- Suitable for maintained or non-maintained use

Construction: Polycarbonate

Lamp type: LED



Height	Projection	Width	(mm)
169	42	324	



Code	Wattage	Model	Colour	CCT	Lumens	Emergency Lumens
EMRNST	4W	Self-Test - 3-Hour	Daylight	6000K	150lm	120lm

SUSPENDED LED EXIT SIGN (4W) AND LEGENDS

- Supplied as standard with arrow up - alternative legends available
- Suitable for maintained or non-maintained use
- Comes with 1.5m suspension kit terminating in aluminium ceiling plate

Construction: Polycarbonate

Lamp type: LED



Height	Length	Width	(mm)
222	332	25	



Code	Wattage	Model	Colour	CCT	Lumens	Emergency Lumens
EMSWING	4W	3-Hour	Daylight	6000K	70lm	34lm

Code	Model
EMSWINGD	Down Legend

Code	Model
EMSWINGLR	Left/Right Legend





DUAL MOUNTING LED EXIT SIGN

- Lightweight, wall or ceiling mounted
- Supplied as standard with arrow up - alternative legends available
- Suitable for maintained or non-maintained use (not switched maintained)
- **EMXST ONLY:** Self-test facility in accordance to EN 62034

AUTO
SELF-TEST

Construction: Aluminium

Lamp type: LED

Height	Length	Projection	(mm)
230	310	44	



Code	Wattage	Model	Colour	CCT	Lumens	Emergency Lumens
EMEXIT	4W	3-Hour	Daylight	6000K	92lm	90lm
EMXST	4W	Self-Test - 3-Hour	Daylight	6000K	40lm	10.5lm

CEILING
MOUNTED

WALL
MOUNTED



SUSPENDED LED EXIT SIGN

- Lightweight suspendable ceiling mounted LED exit sign
- Polycarbonate legends, supplied as standard with arrow up - alternative legends available
- For maintained or non-maintained use (not switched maintained)

Construction: Polycarbonate

Lamp type: LED



Height	Length	Width	(mm)
185	300	45	



Code	Wattage	Model	Colour	CCT	Lumens	Emergency Lumens
EMLSUS	2W	3-Hour	Cool White	6000K	15lm	8lm

RECESSED LED EXIT SIGN

- Polycarbonate legends, supplied as standard with arrow up - alternative legends available
- For maintained or non-maintained use (not switched maintained)

Construction: Polycarbonate

Lamp type: LED



Projection	Length	Width	(mm)
170	335	76	



Code	Wattage	Model	Colour	CCT	Lumens	Emergency Lumens
EMLREC	2W	3-Hour	Cool White	6000K	15lm	8lm

LEGENDS

Code	Model
EMEXITL2	Up Legend
EMEXITL3	Down Legend
EMEXITLR	Left/Right Legend



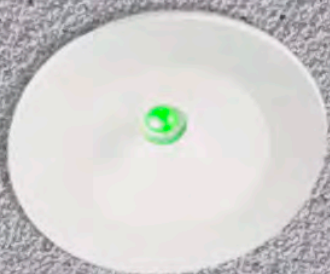

RECESSED LED EMERGENCY DOWNLIGHT

- Supplied with compact energy efficient Li-ion battery
- Suitable for non-maintained use only
- Aluminium, white, and black bezels included

Construction: Die-cast aluminium

Lamp type: LED



WHITE AND BLACK
BEZEL INCLUDED

Overall Ø	Minimum Void	Cut-out Ø (mm)
42	75	34



Code	Wattage	Model	Colour	CCT	Emergency Lumens
EMPOWER3	3W	3-Hour	Daylight	6000K	120lm

SELF TEST RECESSED LED EMERGENCY DOWNLIGHT

- Aluminium body with aluminium, white, and black bezels
- Green LED indicates when downlight is in charging mode
- Supplied pre-wired
- Inverter and battery pack included
- Suitable for non-maintained use only

Construction: Die-cast aluminium

Lamp type: LED



**AUTO
SELF-TEST**

Overall Ø	Minimum Void	Cut-out Ø (mm)
42	75	34



Code	Wattage	Model	Colour	CCT	Emergency Lumens
EMPOWERST	3W	Self-Test - 3-Hour	Daylight	6000K	120lm

EMPOWER2 RECESSED LED EMERGENCY DOWNLIGHT

- Separate green LED indicates when light is in charging mode
- Supplied pre-wired
- Low-profile inverter and battery pack included
- Suitable for maintained or non-maintained use

Construction: Die-cast aluminium

Lamp type: LED



Overall Ø	Minimum Void	Cut-out Ø (mm)
55	80	46

Code	Wattage	Model	Colour	CCT	Emergency Lumens
EMPOWER2	3W	3-Hour	Daylight	6000K	210lm
EMPOWERW2	3W	3-Hour	Warm White	3000K	145lm

HIGH LUMEN RECESSED LED EMERGENCY DOWNLIGHT

- Dual status LED - illuminates green whilst charging and converts to white LED when power is lost
- Inverter and battery pack included
- Ideal for corridors, stairwells, and a variety of commercial and public areas
- Suitable for non-maintained use only

Construction: Die-cast aluminium

Lamp type: LED



Overall Ø	Minimum Void	Cut-out Ø (mm)
68	97	55

Code	Wattage	Model	Colour	CCT	Emergency Lumens
ENM5	5W	3-Hour	Daylight	6000K	340lm



ADAPTABLE EMERGENCY LED DOWNLIGHT

- Slimline, low-profile design, supplied with hole convertor for ease of use
- Adjustable trim with two cut-out diameters
- Inverter and battery pack included
- Manual test button
- Suitable for non-maintained use only

Construction: Polycarbonate

Lamp type: LED

Overall Ø	Minimum Void	Cut-out Ø	(mm)	230V 50Hz	IP20	No rain	LAMP INCLUDED	3 YEAR WARRANTY	
140	80	70-130							

Code	Wattage	Model	Colour	CCT	Emergency Lumens
EMPDL	3W	3-Hour	Daylight	5500K	130lm

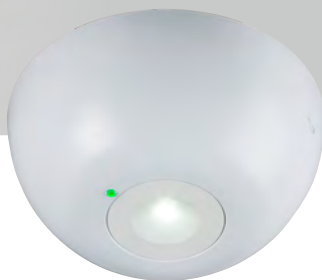

LED SURFACE EMERGENCY DOWNLIGHT

- Surface mounted
- Ideal for commercial and residential use
- Suitable for non-maintained use only

Construction: Polycarbonate

Lamp type: LED

Overall Ø	Projection	(mm)	230V 50Hz	IP20	No rain	LAMP INCLUDED	3 YEAR WARRANTY	
118	50							

Code	Wattage	Model	Colour	CCT	Emergency Lumens
EMSUR	3W	3-Hour	Daylight	6000K	135lm

CPL DOWNLIGHT EMERGENCY KIT

- Compatible with 6W / 12W / 18W / 24W CPL fittings
- Inverter and battery pack included
- Pre-wired with easy-fix connectors and LED charge indicator
- CPL luminaire not included

Construction: Polycarbonate

Length	Height	Width	(mm)
211	24	34	

Code	Model
CPLEM	3-Hour LED Emergency Pack



LED 3-HOUR EMERGENCY KIT

- Converts LED luminaires to 3-hour emergency 50W max.
- Maintained and non-maintained use
- Suitable for Knightsbridge products:
LEDPAN38/LPAN30/PLxxLED/MRBLEDCRDLxx

Construction: Polycarbonate

Height	Length	Width	(mm)
32	225	60	

Code	Model
EMKIT2	LED (Constant Current) Emergency Kit



GU10 LED EMERGENCY KIT

- Pre-wired with easy-fix connectors and LED charge indicator
- For maintained and non-maintained use

*please check compatibility before installation

Construction: Polycarbonate

Lamp type: GU10 LED (6W Max.)

Min. Cut-out Ø	(mm)
55	

Code	Model	Finish
EMGUKIT1	LED Emergency Pack	White







LAMPS & LIGHTING ACCESSORIES

The everyday lighting essentials, including lamps, drivers, fuses, screws and more

E27/E40 LED Corn Lamps	442
LED GU10 Lamps	443
LED Filament Lamps	444
G4 & G9 LED Capsule Lamps	445
Pendant Sets	446 - 447
T8 LED Tubes / GX53 LED Lamp	448
Waterproof Junction Box / Transformer	449
LED Drivers	450 - 451
Suction Cup / Spring Clips / Lamp Holders / Blanking Plug	452
Strip Connectors / Fuses / Screws	453



CRN12CW



CRN36CW



CRN54CW

E27 / E40 CORN LAMPS

- Suitable for indoor use or enclosed outdoor luminaires
- Integral cooling system maximising LED operation
- Suitable for open and closed fixtures
- 360° light distribution

Construction: Polycarbonate

Lamp type: LED

Beam angle: 179°

230V
50Hz

IP20



5
YEAR
WARRANTY

Code	Wattage	Lamp Base	CCT	Lumens	Height
CRN12CW	12W	E27	4000K	1695lm	128mm
CRN18CW	18W	E27	4000K	2495lm	148mm
CRN27CW	27W	E27	4000K	3750lm	173mm
CRN36CW	36W	E40	4000K	5115lm	216mm
CRN54CW	54W	E40	4000K	6870lm	255mm

SMD LED GU10 LAMPS

Construction: Aluminium & polycarbonate

Lamp type: LED

Beam angle: 36°

230V
50Hz

GU5LDWW



GU5LDCW



GU5LDDL



Code	Wattage	Model	Colour	CCT	Lumens	Qty
GU5LDWW	5W	Dimmable	Warm White	3000K	400lm	20
GU5LDCW	5W	Dimmable	Cool White	4000K	440lm	20
GU5LDDL	5W	Dimmable	Daylight	6000K	450lm	20
GU5LWW	5W	Non-Dimmable	Warm White	3000K	380lm	20
GU5LCW	5W	Non-Dimmable	Cool White	4000K	415lm	20
GU5LDL	5W	Non-Dimmable	Daylight	6000K	430lm	20

HIGH LUMEN SMD LED GU10 LAMPS

Construction: Glass & polycarbonate

Lamp type: LED

Beam angle: 38°

230V
50Hz



G5DWW



G5DCW



Code	Wattage	Colour	CCT	Lumens	Qty
G5DWW	5W	Warm White	2700K	500lm	10 NEW
G5DCW	5W	Cool White	4000K	570lm	10 NEW



CLD4BCC



CLD4ESC



CLD4SBCC



CLD4SESC



CLD4SESO



CLD6SESC



CLD6ESC

230V
50Hz

CLEAR / FROSTED CANDLE

Code	Wattage	Model	Lamp Type	Colour	CCT	Height	Overall Ø	Lumens
CLD4BCC	4W	Clear Candle	BC	Warm White	2700K	91mm	35mm	430lm
CLD4ESC	4W	Clear Candle	ES	Warm White	2700K	93mm	35mm	430lm
CLD4SBCC	4W	Clear Candle	SBC	Warm White	2700K	95mm	35mm	430lm
CLD4SESC	4W	Clear Candle	SES	Warm White	2700K	97mm	35mm	430lm
CLD4SESO	4W	Frosted Candle	SES	Warm White	2700K	97mm	35mm	400lm
CLD6ESC	5W	Clear Candle	ES	Warm White	2700K	93mm	35mm	515lm
CLD6SESC	5W	Clear Candle	SES	Warm White	2700K	97mm	35mm	515lm



GBD4ESC



GBD4SESC

230V
50Hz

GOLF BALL

Code	Wattage	Model	Lamp Type	Colour	CCT	Height	Overall Ø	Lumens
GBD4ESC	4W	Clear Golf Ball	ES	Warm White	2700K	72mm	45mm	430lm
GBD4SESC	4W	Clear Golf Ball	SES	Warm White	2700K	78mm	45mm	430lm



GLSD8BCC



GLSD8ESC

230V
50Hz

CLEAR GLS

Code	Wattage	Model	Lamp Type	Colour	CCT	Height	Overall Ø	Lumens
GLSD8BCC	8W	Clear GLS	BC	Warm White	2700K	103mm	60mm	890lm
GLSD8ESC	8W	Clear GLS	ES	Warm White	2700K	105mm	60mm	890lm



12V G4 BASE LED CAPSULE LAMPS

- Suitable for use with AC and DC

Construction: (G4LED5/6) thermoplastic and (G4COB1/2) silicone

Lamp type: LED

12V



Code	Wattage	Colour	CCT	Height	Overall Ø	Lumens	Qty
G4LED5	1.5W	Warm White	2700K	32mm	10.2mm	95lm	10 NEW
G4LED6	1.5W	Cool White	4000K	32mm	10.2mm	110lm	10 NEW
G4COB1	1.5W	Warm White	2700K	36mm	10mm	185lm	10 NEW
G4COB2	1.5W	Cool White	4000K	36mm	10mm	195lm	10 NEW



G9 BASE LED CAPSULE LAMPS

- Suitable replacement for most G9 halogen lamps
- Dimmable where stated

Lamp type: LED

230V
50Hz

Code	Wattage	Model	Colour	CCT	Height	Overall Ø	Lumens	Qty
G9LED8	4W	Non-Dimmable	Warm White	2700K	50mm	16mm	370lm	10
G9LED9	4W	Non-Dimmable	Cool White	4000K	50mm	16mm	370lm	10
G9LED10	2W	Non-Dimmable	Warm White	2700K	43mm	16mm	200lm	10
G9LED11	2W	Non-Dimmable	Cool White	4000K	43mm	16mm	200lm	10
G9LED16	4W	Dimmable	Warm White	2700K	54mm	19mm	390lm	10 NEW
G9LED17	4W	Dimmable	Cool White	4000K	54mm	19mm	430lm	10 NEW



- 3 plate format
- Metal finish ceiling rose and lampholder
- Braided cord flex
- Contemporary styled lampholder

6" CONTEMPORARY METAL PENDANT SETS

Code	Size	Model	
8270MB	6" T2 E27	Matt Black	
8270MW	6" T2 E27	Matt White	
8270BC	6" T2 E27	Brushed Chrome	
8270PC	6" T2 E27	Polished Chrome	
8270BN	6" T2 E27	Black Nickel	
8270AB	6" T2 E27	Antique Brass	
8270PB	6" T2 E27	Polished Brass	
8270AT	6" T2 E27	Anthracite	NEW
8270SB	6" T2 E27	Smoked Bronze	NEW



1.8M CONTEMPORARY METAL PENDANT SETS

Code	Size	Model	
8270LMB	1.8m T2 E27	Matt Black	NEW
8270LMW	1.8m T2 E27	Matt White	NEW
8270LBC	1.8m T2 E27	Brushed Chrome	NEW
8270LPC	1.8m T2 E27	Polished Chrome	NEW
8270LBN	1.8m T2 E27	Black Nickel	NEW
8270LAB	1.8m T2 E27	Antique Brass	NEW
8270LPB	1.8m T2 E27	Polished Brass	NEW
8270LAT	1.8m T2 E27	Anthracite	NEW
8270LSB	1.8m T2 E27	Smoked Bronze	NEW



- 3 plate format
- Metal finish ceiling rose and lampholder
- Braided cord flex
- Vintage styled lampholder

6" VINTAGE METAL PENDANT SETS

Code	Size	Model	
8271MB	6" T2 E27	Matt Black	NEW
8271MW	6" T2 E27	Matt White	NEW
8271BC	6" T2 E27	Brushed Chrome	
8271PC	6" T2 E27	Polished Chrome	
8271BN	6" T2 E27	Black Nickel	
8271AB	6" T2 E27	Antique Brass	
8271PB	6" T2 E27	Polished Brass	
8271AT	6" T2 E27	Anthracite	NEW
8271SB	6" T2 E27	Smoked Bronze	NEW



1.8M VINTAGE METAL PENDANT SETS

Code	Size	Model	
8271LMB	1.8m T2 E27	Matt Black	NEW
8271LMW	1.8m T2 E27	Matt White	NEW
8271LBC	1.8m T2 E27	Brushed Chrome	NEW
8271LPC	1.8m T2 E27	Polished Chrome	NEW
8271LBN	1.8m T2 E27	Black Nickel	NEW
8271LAB	1.8m T2 E27	Antique Brass	NEW
8271LPB	1.8m T2 E27	Polished Brass	NEW
8271LAT	1.8m T2 E27	Anthracite	NEW
8271LSB	1.8m T2 E27	Smoked Bronze	NEW



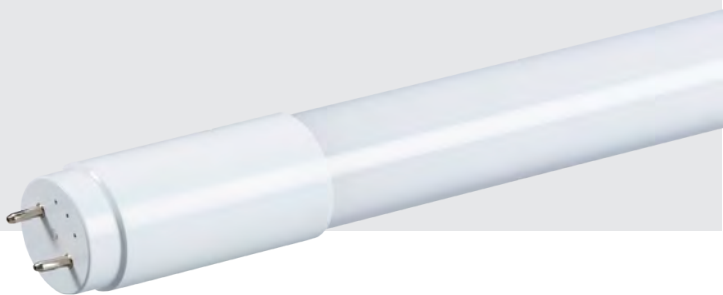

T8 LED TUBES

- Alternative to classic T8 fluorescent lamps
- Up to 130lm/W
- Instant ignition provides uniform illumination
- Integral driver for ease of installation
- Not for use with external electronic or magnetic ballasts

230V
50Hz



Lamp type: LED

Code	Wattage	Construction	Colour	CCT	Length	Overall Ø	Lumens	Qty
T8LEDP9CW	9W	Glass	Cool White	4000K	603mm	27mm	1090lm	4
T8LEDP9DL	9W	Glass	Daylight	6000K	603mm	27mm	1080lm	4
T8LEDP18CW	18W	Glass	Cool White	4000K	1212mm	27mm	2295lm	4
T8LEDP18DL	18W	Glass	Daylight	6000K	1212mm	27mm	2230lm	4
T8LEDP24CW	24W	Glass	Cool White	4000K	1512mm	27mm	2980lm	4
T8LEDP24DL	24W	Glass	Daylight	6000K	1512mm	27mm	2895lm	4
T8LED6	30W	Polycarbonate	Cool White	4000K	1778mm	26mm	3350lm	1
T8LED6D	30W	Polycarbonate	Daylight	6000K	1778mm	26mm	3400lm	1

GX53 LED LAMP

Construction: Polycarbonate & acrylic

Lamp type: LED



230V
50Hz



Code	Wattage	Colour	CCT	Height	Overall Ø	Lumens
GXLED3K	5W	Warm White	3000K	26mm	75mm	400lm
GXLED5K	5W	Daylight	5000K	26mm	75mm	430lm

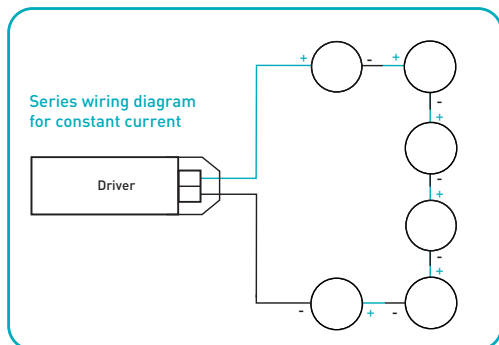

IP68 WATERPROOF JUNCTION BOX

- To be wired in series (refer to diagram)

Code	Model
IP68JBS	Max. Load 48V DC 20W



TRANSFORMER T02

- Dimmable, thermal overload, and short circuit protection

Code	Model	Length	Width	Height
T02	20W - 60W	120mm	30mm	23mm



12V IP20 CONSTANT VOLTAGE LED DRIVER

Code	Model	Length	Width	Height
12VDCA	12V 12W	98mm	39mm	22mm
12DC40	12V 40W	166mm	52mm	24mm
12DC75	12V 75W	184mm	61mm	32mm

NEW



24V IP20 CONSTANT VOLTAGE LED DRIVER

Code	Model	Length	Width	Height
24VDCA	24V 12W	98mm	36mm	22mm
24DC40	24V 40W	166mm	52mm	24mm
24DC75	24V 75W	184mm	61mm	32mm

NEW



12V IP20 CONSTANT VOLTAGE DIMMABLE LED DRIVER

- Compatible with most trailing-edge dimmers

Code	Model	Length	Width	Height
12DC25D	12V 25W	128mm	52mm	30mm
12DC50D	12V 50W	184mm	61mm	32mm



24V IP20 CONSTANT VOLTAGE DIMMABLE LED DRIVER

- Compatible with most trailing-edge dimmers

Code	Model	Length	Width	Height
24DC25D	24V 25W	128mm	52mm	30mm
24DC50D	24V 50W	184mm	61mm	32mm
24DC100D	24V 100W	210mm	67mm	34mm

12V IP67 CONSTANT VOLTAGE LED DRIVER



Code	Model	Length	Width	Height	
12DCIP40	12V 40W	182mm	30mm	58mm	NEW

24V IP67 CONSTANT VOLTAGE LED DRIVER



Code	Model	Length	Width	Height	
24DCIP40	24V 40W	182mm	58mm	30mm	NEW
24DCIP75	24V 75W	199mm	67mm	35mm	NEW
24DCIP100A	24V 100W	199mm	67mm	35mm	NEW

IP20 CONSTANT CURRENT LED DRIVERS

- Compatible with most trailing-edge dimmers (dimnable models)



Code	Model	Length	Width	Height	
1W350DA	18-35V 350mA 12W (Dimmable)	98mm	39mm	22mm	
1W210DA	12-40V 350mA 16.5W (Dimmable)	125mm	41mm	29mm	
1W350A	2-34V 350mA 12W (Non-Dimmable)	98mm	39mm	22mm	
25W350DA	36-72V 350mA 25W (Dimmable)	120mm	45mm	28mm	
25W700DA	18-36V 700mA 25W (Dimmable)	120mm	45mm	28mm	
40W700DA	28-56V 700mA 40W (Dimmable)	166mm	52mm	25mm	



BLANKING PLUG

Code	Model	Qty
1390	Blanking Plug	5



RUBBER SUCTION CUP

- For easy changing of GU10 lamps

Code	Model	Qty
LSC1	Rubber Suction Cup	10



SPRING CLIPS FOR LOW VOLTAGE FITTINGS

Code	Model	Qty
LVC1	50mm	100
LVC2	35mm	100



LH01C



LH02



LH03



LH04

LAMP HOLDERS

Code	Model	Qty
LH01	Low Voltage with 180mm Silicon Cable	50
LH01C	Low Voltage with 180mm Silicon Cable and Metal Clip	50
LH02	GU10 with 260mm Silicon Cable	50
LH03	GU10 with Bridge and Separate Earth Terminal	50
LH04	Low Voltage with Bridge	50



STRIP CONNECTORS

- 380V terminal strips for connecting electrical cable
- 12-Way terminal block
- Made with PA66 material (UL94-V2 self extinguishing) EN 60947, operating temperature: -30°C to +110°C

Code	Model	Qty
SC3PA	3A	10
SC5PA	5A	10
SC15PA	15A	10
SC30PA	30A	10
SC60PA	60A	10



FUSES (ASTA Approved)

Code	Model	Qty
SN3AFUSE	3A	10
SN5AFUSE	5A	10
SN13AFUSE	13A	10
SNMIXEDFUSE	Mixed Pack (3 x 3A, 3 x 5A, 4 x 13A)	10



FLAT-HEAD ELECTRICAL FIXING SCREWS

- Ideal for use with the Screwless and Flat Plate ranges

Code	Model	Qty
C-SCREW50B	M3.5 x 50mm Brass	100
C-SCREW50N	M3.5 x 50mm Nickel	100
C-SCREW50BK	M3.5 x 50mm Black Nickel and Gunmetal	100

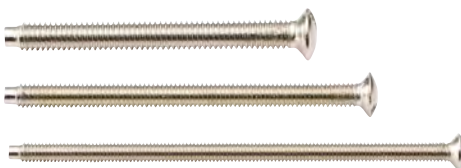

RAISED-HEAD ELECTRICAL FIXING SCREWS

- Ideal for use with square, curved, or raised edge ranges

Code	Model	Qty
CSCREW35	M3.5 x 35mm Nickel	100
CSCREW50	M3.5 x 50mm Nickel	100
CSCREW75	M3.5 x 75mm Nickel	100



INDEX

No.				No.			
Code	Catalogue Section	Qty	Page	Code	Catalogue Section	Qty	Page
1350	Wiring Basics	10	183	8270AT	Wiring Basics	1	180
1375	Wiring Basics	10	183	8270BC	Wiring Basics	1	180
8910	Wiring Basics	20	183	8270BN	Wiring Basics	1	180
12DC25D	LED Flex	1	304	8270LAB	Wiring Basics	1	180
12DC40	LED Flex	1	304	8270LAT	Wiring Basics	1	180
12DC50D	LED Flex	1	304	8270LBC	Wiring Basics	1	180
12DC75	LED Flex	1	304	8270LBN	Wiring Basics	1	180
12DCIP40	LED Flex	1	304	8270LMB	Wiring Basics	1	180
12GTOWER	Wiring Basics	1	183	8270LMW	Wiring Basics	1	180
12VDCA	LED Flex	1	304	8270LPB	Wiring Basics	1	180
1GAKW	Smart Home	1	205	8270LPC	Wiring Basics	1	180
1GSBBC	Wiring Basics	1	179	8270LSB	Wiring Basics	1	180
1GSBBK	Wiring Basics	1	179	8270MB	Wiring Basics	1	180
1GSBGY	Wiring Basics	1	179	8270MW	Wiring Basics	1	180
1GSBPC	Wiring Basics	1	179	8270PB	Wiring Basics	1	180
1GSBW	Wiring Basics	1	179	8270PC	Wiring Basics	1	180
1IPB	Groundlights & Deck Lighting	1	355	8270SB	Wiring Basics	1	180
1IPW	Groundlights & Deck Lighting	1	355	8271AB	Wiring Basics	1	181
1MPRF	LED Flex	1	301	8271AT	Wiring Basics	1	181
1MPSC	LED Flex	1	301	8271BC	Wiring Basics	1	181
1MPSC	LED Flex	1	301	8271BN	Wiring Basics	1	181
1W210DA	Lamps & Lighting Accessories	1	451	8271LAB	Wiring Basics	1	181
1W350A	Lamps & Lighting Accessories	1	451	8271LAT	Wiring Basics	1	181
1W350DA	Lamps & Lighting Accessories	1	451	8271LBC	Wiring Basics	1	181
20042M	Wiring Basics	1	183	8271LBN	Wiring Basics	1	181
20043M	Wiring Basics	1	183	8271LMB	Wiring Basics	1	181
200452M	Wiring Basics	1	183	8271LMW	Wiring Basics	1	181
20062M	Wiring Basics	1	183	8271LPB	Wiring Basics	1	181
200652M	Wiring Basics	1	183	8271LPC	Wiring Basics	1	181
24DC100D	LED Flex	1	304	8271LSB	Wiring Basics	1	181
24DC25D	LED Flex	1	304	8271MB	Wiring Basics	1	181
24DC40	LED Flex	1	304	8271MW	Wiring Basics	1	181
24DC50D	LED Flex	1	304	8271PB	Wiring Basics	1	181
24DC75	LED Flex	1	304	8271PC	Wiring Basics	1	181
24DCIP100A	LED Flex	1	304	8271SB	Wiring Basics	1	181
24DCIP40	LED Flex	1	304	8300AB	Wiring Basics	1	182
24DCIP75	LED Flex	1	304	8300AT	Wiring Basics	1	182
24VDCA	LED Flex	1	304	8300BC	Wiring Basics	1	182
25W350DA	Lamps & Lighting Accessories	1	451	8300BN	Wiring Basics	1	182
25W700DA	Lamps & Lighting Accessories	1	451	8300MB	Wiring Basics	1	182
2GPHBK	Raised Edge - Rounded	1	33	8300MW	Wiring Basics	1	182
2GPHGY	Raised Edge - Rounded	1	33	8300PC	Wiring Basics	1	182
2GPHW	Moulded Square Edge	1	9	8300SB	Wiring Basics	1	182
2GSBBC	Wiring Basics	1	179	8GTOWER	Wiring Basics	1	183
2GSBBK	Wiring Basics	1	179	A.			
2GSBGY	Wiring Basics	1	179	Code	Catalogue Section	Qty	Page
2GSBPC	Wiring Basics	1	179	AC65118	Non-corrosive	1	419
2GSBW	Wiring Basics	1	179	AC65136	Non-corrosive	1	419
316WALK	Groundlights & Deck Lighting	1	349	AC65136EM	Non-corrosive	1	419
3GKW	Smart Home	1	205	AC65158	Non-corrosive	1	419
40W700DA	Lamps & Lighting Accessories	1	451	AC651581	Non-corrosive	1	419
4IPB	Groundlights & Deck Lighting	1	355	AC651581EM	Non-corrosive	1	419
4IPW	Groundlights & Deck Lighting	1	355	AC65158EM	Non-corrosive	1	419
5401A	Outdoor Wall Lights & Bollards	1	331	AC65170	Non-corrosive	1	419
5FTTSKIT	Recessed, Surface & Suspension	1	397	AC65170EM	Non-corrosive	1	419
8270AB	Wiring Basics	1	180	AC65218	Non-corrosive	1	419

A.				B.			
Code	Catalogue Section	Qty	Page	Code	Catalogue Section	Qty	Page
AC65236	Non-corrosive	1	419	BATC6EMH	Battens	1	408
AC65236EM	Non-corrosive	1	419	BATC6H	Battens	1	408
AC65258	Non-corrosive	1	419	BATC6S	Battens	1	408
AC652581	Non-corrosive	1	419	BATS2	Battens	1	406
AC652581EM	Non-corrosive	1	419	BATS4	Battens	1	406
AC65258EM	Non-corrosive	1	419	BATS4EM	Battens	1	406
AC65270	Non-corrosive	1	419	BATS4S	Battens	1	406
AC65270EM	Non-corrosive	1	419	BATS5	Battens	1	406
ACCLIP	Non-corrosive	20	417	BATS5EM	Battens	1	406
AMLEDB	Bulkheads & Wall Packs	1	380	BATS5EMH	Battens	1	407
AMLEDBP	Bulkheads & Wall Packs	1	380	BATS5EMS	Battens	1	406
AMLEDBS	Bulkheads & Wall Packs	1	380	BATS5H	Battens	1	406
AMLEDR	Bulkheads & Wall Packs	1	380	BATS5S	Battens	1	407
AMLEDW	Bulkheads & Wall Packs	1	380	BATS5UHL	Battens	1	406
AMLEDWP	Bulkheads & Wall Packs	1	380	BATS5UHLEM	Battens	1	406
AMLEDWS	Bulkheads & Wall Packs	1	380	BATS6	Battens	1	407
AVAC15	Datacomms	1	158	BATS6EM	Battens	1	407
AVCC15	Datacomms	1	158	BATS6EMH	Battens	1	407
AVHD4K10	Datacomms	1	157	BATS6EMS	Battens	1	407
AVHD4K2	Datacomms	1	157	BATS6H	Battens	1	407
AVHD4K3	Datacomms	1	157	BATS6S	Battens	1	407
AVHD4K5	Datacomms	1	157	BATS6UHL	Battens	1	407
AVPDCC15	Datacomms	1	158	BATS6UHLEM	Battens	1	407
AVUHD8K2	Datacomms	1	157	BF1430	Bulkheads & Wall Packs	1	376
B.				BF1430EM	Bulkheads & Wall Packs	1	376
BA01B3C	Bathroom	1	267	BF1430EMS	Bulkheads & Wall Packs	1	376
BA01B3MB	Bathroom	1	267	BF1430S	Bulkheads & Wall Packs	1	376
BA01P3C	Bathroom	1	267	BF14BBR	Bulkheads & Wall Packs	1	376
BA01P3MB	Bathroom	1	267	BF14BCHR	Bulkheads & Wall Packs	1	376
BA01S1C	Bathroom	1	266	BF14BMS	Bulkheads & Wall Packs	1	376
BA01S1MB	Bathroom	1	266	BF14BWHT	Bulkheads & Wall Packs	1	376
BA02B3C	Bathroom	1	269	BF14L4K	Bulkheads & Wall Packs	1	376
BA02B3MB	Bathroom	1	269	BF2440	Bulkheads & Wall Packs	1	376
BA02P3C	Bathroom	1	268	BF2440EM	Bulkheads & Wall Packs	1	376
BA02P3MB	Bathroom	1	268	BF2440EMS	Bulkheads & Wall Packs	1	376
BA02S1C	Bathroom	1	268	BF2440S	Bulkheads & Wall Packs	1	376
BA02S1MB	Bathroom	1	268	BF24BBR	Bulkheads & Wall Packs	1	376
BA03B3C	Bathroom	1	271	BF24BCHR	Bulkheads & Wall Packs	1	376
BA03B3MB	Bathroom	1	271	BF24BMS	Bulkheads & Wall Packs	1	376
BA03B3MW	Bathroom	1	271	BF24BWHT	Bulkheads & Wall Packs	1	376
BA03P3C	Bathroom	1	271	BF24L4K	Bulkheads & Wall Packs	1	376
BA03P3MB	Bathroom	1	271	BH22BC	Bulkheads & Wall Packs	1	381
BA03P3MW	Bathroom	1	271	BH22PB	Bulkheads & Wall Packs	1	381
BA03S1C	Bathroom	1	270	BL01BK	Outdoor Wall Lights & Bollards	1	326
BA03S1MB	Bathroom	1	270	BL12LED	Bulkheads & Wall Packs	1	374
BA03S1MW	Bathroom	1	270	BL12LEDE	Bulkheads & Wall Packs	1	374
BATC4	Battens	1	408	BL12LEDS	Bulkheads & Wall Packs	1	374
BATC4EM	Battens	1	408	BL20LED	Bulkheads & Wall Packs	1	374
BATC5	Battens	1	408	BL20LEDE	Bulkheads & Wall Packs	1	374
BATC5EM	Battens	1	408	BL20LEDS	Bulkheads & Wall Packs	1	374
BATC5EMH	Battens	1	408	BL5BK	Outdoor Wall Lights & Bollards	1	324
BATC5H	Battens	1	408	BL5BLK	Outdoor Wall Lights & Bollards	1	325
BATC5S	Battens	1	408	BL5BLG	Outdoor Wall Lights & Bollards	1	325
BATC6	Battens	1	408	BL5G	Outdoor Wall Lights & Bollards	1	324
BATC6EM	Battens	1	408	BLED5BB	Outdoor Wall Lights & Bollards	1	326
				BLED5BW	Outdoor Wall Lights & Bollards	1	326

B.

Code	Catalogue Section	Qty	Page
BLED55B	Outdoor Wall Lights & Bollards	1	326
BLED55W	Outdoor Wall Lights & Bollards	1	326
BLKITBK	Outdoor Wall Lights & Bollards	1	325
BLKITG	Outdoor Wall Lights & Bollards	1	325
BPLED	Bulkheads & Wall Packs	1	377
BPLEDEM	Bulkheads & Wall Packs	1	377
BT14ACTB	Bathroom	1	281
BT14ACTCH	Bathroom	1	281
BT14B	Bulkheads & Wall Packs	1	373
BT14CHR	Bulkheads & Wall Packs	1	373
BT14CT	Bulkheads & Wall Packs	1	372
BT14CTA	Bulkheads & Wall Packs	1	372
BT14CTEM	Bulkheads & Wall Packs	1	372
BT14CTEMA	Bulkheads & Wall Packs	1	372
BT14CTEMS	Bulkheads & Wall Packs	1	372
BT14CTS	Bulkheads & Wall Packs	1	372
BT14EB	Bulkheads & Wall Packs	1	373
BT14EG	Bulkheads & Wall Packs	1	373
BT14ES	Bulkheads & Wall Packs	1	373
BT14G	Bulkheads & Wall Packs	1	373
BT14MBR	Bulkheads & Wall Packs	1	373
BT14SLV	Bulkheads & Wall Packs	1	373
BT20B	Bulkheads & Wall Packs	1	373
BT20CHR	Bulkheads & Wall Packs	1	373
BT20CT	Bulkheads & Wall Packs	1	372
BT20CTA	Bulkheads & Wall Packs	1	372
BT20CTEM	Bulkheads & Wall Packs	1	372
BT20CTEMA	Bulkheads & Wall Packs	1	372
BT20CTEMS	Bulkheads & Wall Packs	1	372
BT20CTS	Bulkheads & Wall Packs	1	372
BT20G	Bulkheads & Wall Packs	1	373
BT20MBR	Bulkheads & Wall Packs	1	373
BT20SLV	Bulkheads & Wall Packs	1	373
BT9ACTB	Bathroom	1	281
BT9ACTCH	Bathroom	1	281
BT9B	Bulkheads & Wall Packs	1	373
BT9CHR	Bulkheads & Wall Packs	1	373
BT9CT	Bulkheads & Wall Packs	1	372
BT9CTEM	Bulkheads & Wall Packs	1	372
BT9CTEMS	Bulkheads & Wall Packs	1	372
BT9CTS	Bulkheads & Wall Packs	1	372
BT9EB	Bulkheads & Wall Packs	1	373
BT9EG	Bulkheads & Wall Packs	1	373
BT9ES	Bulkheads & Wall Packs	1	373
BT9G	Bulkheads & Wall Packs	1	373
BT9MBR	Bulkheads & Wall Packs	1	373
BT9SLV	Bulkheads & Wall Packs	1	373
BWLED1	Bathroom	1	273
BWLED10	Bathroom	1	273
BWLED2	Bathroom	1	273
BWLED4	Bathroom	1	272
BWLED9	Bathroom	1	272

C.

Code	Catalogue Section	Qty	Page
CABBCCW	Under Cabinet	1	292
CABBCWW	Under Cabinet	1	292

C.

Code	Catalogue Section	Qty	Page
CABCCW	Under Cabinet	1	292
CABCWW	Under Cabinet	1	292
CABWCW	Under Cabinet	1	292
CABWWW	Under Cabinet	1	292
CAMFIX01	Smart Home	1	207
CAPCOVERS	Wiring Basics	100	184
CAPWGU	Groundlights & Deck Lighting	1	351
CFR5CW	Downlights	1	233
CFR5DL	Downlights	1	233
CFR5WW	Downlights	1	233
CFRB	Downlights	1	233
CFRBC	Downlights	1	233
CFRMB	Downlights	1	233
CFRPC	Downlights	1	233
CFRW	Downlights	1	233
CL010BC	Raised Edge - Rounded	1	39
CL010PC	Raised Edge - Rounded	1	39
CL014BC	Raised Edge - Rounded	1	39
CL014PC	Raised Edge - Rounded	1	39
CL015BC	Raised Edge - Rounded	1	39
CL015PC	Raised Edge - Rounded	1	39
CL016BC	Raised Edge - Rounded	1	39
CL11BC	Raised Edge - Rounded	1	34
CL11PC	Raised Edge - Rounded	1	34
CL12BC	Raised Edge - Rounded	1	35
CL12PC	Raised Edge - Rounded	1	35
CL16BC	Raised Edge - Rounded	1	40
CL16PC	Raised Edge - Rounded	1	40
CL2181BC	Raised Edge - Rounded	1	36
CL2181PC	Raised Edge - Rounded	1	36
CL2182BC	Raised Edge - Rounded	1	36
CL2182PC	Raised Edge - Rounded	1	36
CL2183BC	Raised Edge - Rounded	1	36
CL2183PC	Raised Edge - Rounded	1	36
CL2184BC	Raised Edge - Rounded	1	36
CL2184PC	Raised Edge - Rounded	1	36
CL2BC	Raised Edge - Rounded	1	35
CL26BC	Raised Edge - Rounded	1	40
CL26PC	Raised Edge - Rounded	1	40
CL2PC	Raised Edge - Rounded	1	35
CL3BC	Raised Edge - Rounded	1	35
CL3PC	Raised Edge - Rounded	1	35
CL41BC	Raised Edge - Rounded	1	35
CL41PC	Raised Edge - Rounded	1	35
CL42BC	Raised Edge - Rounded	1	35
CL42PC	Raised Edge - Rounded	1	35
CL45BC	Raised Edge - Rounded	1	39
CL45PC	Raised Edge - Rounded	1	39
CL4BC	Raised Edge - Rounded	1	35
CL4GBC	Raised Edge - Rounded	1	40
CL4GPC	Raised Edge - Rounded	1	40
CL4PC	Raised Edge - Rounded	1	35
CL5ABC	Raised Edge - Rounded	1	34
CL5ABCG	Raised Edge - Rounded	1	34
CL5ABCW	Raised Edge - Rounded	1	34
CL5APC	Raised Edge - Rounded	1	34

C.			
Code	Catalogue Section	Qty	Page
CL5APCG	Raised Edge - Rounded	1	34
CL5APCW	Raised Edge - Rounded	1	34
CL5KW	Smart Home	1	212
CL63BC	Raised Edge - Rounded	1	37
CL63FBC	Raised Edge - Rounded	1	37
CL63FPC	Raised Edge - Rounded	1	37
CL63NBC	Raised Edge - Rounded	1	37
CL63NPC	Raised Edge - Rounded	1	37
CL63PC	Raised Edge - Rounded	1	37
CL6BC	Raised Edge - Rounded	1	37
CL6PC	Raised Edge - Rounded	1	37
CL73BC	Raised Edge - Rounded	1	39
CL73PC	Raised Edge - Rounded	1	39
CL74BC	Raised Edge - Rounded	1	39
CL74PC	Raised Edge - Rounded	1	39
CL7BC	Raised Edge - Rounded	1	33
CL7BCG	Raised Edge - Rounded	1	33
CL7BCW	Raised Edge - Rounded	1	33
CL7PC	Raised Edge - Rounded	1	33
CL7PCG	Raised Edge - Rounded	1	33
CL7PCW	Raised Edge - Rounded	1	33
CL81NBC	Raised Edge - Rounded	1	38
CL81NPC	Raised Edge - Rounded	1	38
CL82NBC	Raised Edge - Rounded	1	38
CL82NPC	Raised Edge - Rounded	1	38
CL834BC	Raised Edge - Rounded	1	37
CL834FBC	Raised Edge - Rounded	1	37
CL834FPC	Raised Edge - Rounded	1	37
CL834NBC	Raised Edge - Rounded	1	37
CL834NPC	Raised Edge - Rounded	1	37
CL834PC	Raised Edge - Rounded	1	37
CL83BC	Raised Edge - Rounded	1	38
CL83BCG	Raised Edge - Rounded	1	38
CL83BCW	Raised Edge - Rounded	1	38
CL83PC	Raised Edge - Rounded	1	38
CL83PCG	Raised Edge - Rounded	1	38
CL83PCW	Raised Edge - Rounded	1	38
CL85BC	Raised Edge - Rounded	1	40
CL85PC	Raised Edge - Rounded	1	40
CL86BC	Raised Edge - Rounded	1	40
CL86PC	Raised Edge - Rounded	1	40
CL89BC	Raised Edge - Rounded	1	34
CL89BCG	Raised Edge - Rounded	1	34
CL89BCW	Raised Edge - Rounded	1	34
CL89PC	Raised Edge - Rounded	1	34
CL89PCG	Raised Edge - Rounded	1	34
CL89PCW	Raised Edge - Rounded	1	34
CL9124BC	Raised Edge - Rounded	1	33
CL9124BCG	Raised Edge - Rounded	1	33
CL9124BCW	Raised Edge - Rounded	1	33
CL9124PC	Raised Edge - Rounded	1	33
CL9124PCG	Raised Edge - Rounded	1	33
CL9124PCW	Raised Edge - Rounded	1	33
CL9224BC	Raised Edge - Rounded	1	32
CL9224BCG	Raised Edge - Rounded	1	32
CL9224BCW	Raised Edge - Rounded	1	32

C.			
Code	Catalogue Section	Qty	Page
CL9224PC	Raised Edge - Rounded	1	32
CL9224PCG	Raised Edge - Rounded	1	32
CL9224PCW	Raised Edge - Rounded	1	32
CL9BC	Raised Edge - Rounded	1	32
CL9BCG	Raised Edge - Rounded	1	32
CL9BCW	Raised Edge - Rounded	1	32
CL9PC	Raised Edge - Rounded	1	32
CL9PCG	Raised Edge - Rounded	1	32
CL9PCW	Raised Edge - Rounded	1	32
CLD4BCC	Lamps & Lighting Accessories	1	444
CLD4ESC	Lamps & Lighting Accessories	1	444
CLD4SBCC	Lamps & Lighting Accessories	1	444
CLD4SESC	Lamps & Lighting Accessories	1	444
CLD4SESO	Lamps & Lighting Accessories	1	444
CLD6ESC	Lamps & Lighting Accessories	1	444
CLD6SESC	Lamps & Lighting Accessories	1	444
CLTOG12BC	Raised Edge - Rounded	1	36
CLTOG12PC	Raised Edge - Rounded	1	36
CLTOG1BC	Raised Edge - Rounded	1	36
CLTOG1PC	Raised Edge - Rounded	1	36
CLTOG2BC	Raised Edge - Rounded	1	36
CLTOG2PC	Raised Edge - Rounded	1	36
CLTOG3BC	Raised Edge - Rounded	1	36
CLTOG3PC	Raised Edge - Rounded	1	36
CLTOG4BC	Raised Edge - Rounded	1	36
CLTOG4PC	Raised Edge - Rounded	1	36
CON2P	LED Flex	1	303
CONFLEX2P	LED Flex	1	303
CONFLEX3P	LED Flex	1	303
CONFLEX4P	LED Flex	1	303
CONFLEX5P	LED Flex	1	303
CONX2P	LED Flex	1	303
CPL12BC	Commercial Downlights	1	383
CPL12CT	Commercial Downlights	1	383
CPL12MB	Commercial Downlights	1	383
CPL12PC	Commercial Downlights	1	383
CPL18BC	Commercial Downlights	1	384
CPL18CT	Commercial Downlights	1	384
CPL18MB	Commercial Downlights	1	384
CPL18PC	Commercial Downlights	1	384
CPL18WCT	Commercial Downlights	1	384
CPL24BC	Commercial Downlights	1	384
CPL24CT	Commercial Downlights	1	384
CPL24MB	Commercial Downlights	1	384
CPL24PC	Commercial Downlights	1	384
CPL24WCT	Commercial Downlights	1	384
CPL6BC	Commercial Downlights	1	383
CPL6CT	Commercial Downlights	1	383
CPL6MB	Commercial Downlights	1	383
CPL6PC	Commercial Downlights	1	383
CPEM	Emergency	1	439
CRDL10	Commercial Downlights	1	386
CRDL15	Commercial Downlights	1	386
CRDL20	Commercial Downlights	1	386
CRDL30	Commercial Downlights	1	386
CRFO2B	Under Cabinet	1	293

C.

Code	Catalogue Section	Qty	Page
CRF02C	Under Cabinet	1	293
CRF02CBB	Under Cabinet	1	293
CRF02W	Under Cabinet	1	293
CRN12CW	Lamps & Lighting Accessories	1	442
CRN18CW	Lamps & Lighting Accessories	1	442
CRN27CW	Lamps & Lighting Accessories	1	442
CRN36CW	Lamps & Lighting Accessories	1	442
CRN54CW	Lamps & Lighting Accessories	1	442
CRN54CW	Lamps & Lighting Accessories	1	442
CS010AB	Raised Edge - Square	1	56
CS010BC	Raised Edge - Square	1	56
CS014AB	Raised Edge - Square	1	56
CS014BC	Raised Edge - Square	1	56
CS015AB	Raised Edge - Square	1	56
CS015BC	Raised Edge - Square	1	56
CS11AB	Raised Edge - Square	1	51
CS11BC	Raised Edge - Square	1	51
CS12AB	Raised Edge - Square	1	52
CS12BC	Raised Edge - Square	1	52
CS1GAB	Raised Edge - Square	1	57
CS1GBC	Raised Edge - Square	1	57
CS2181AB	Raised Edge - Square	1	53
CS2181BC	Raised Edge - Square	1	53
CS2182AB	Raised Edge - Square	1	53
CS2182BC	Raised Edge - Square	1	53
CS2183AB	Raised Edge - Square	1	53
CS2183BC	Raised Edge - Square	1	53
CS2184AB	Raised Edge - Square	1	53
CS2184BC	Raised Edge - Square	1	53
CS2AB	Raised Edge - Square	1	52
CS2BC	Raised Edge - Square	1	52
CS2GAB	Raised Edge - Square	1	57
CS2GBC	Raised Edge - Square	1	57
CS3AB	Raised Edge - Square	1	52
CS3BC	Raised Edge - Square	1	52
CS41AB	Raised Edge - Square	1	52
CS41BC	Raised Edge - Square	1	52
CS42AB	Raised Edge - Square	1	52
CS42BC	Raised Edge - Square	1	52
CS45AB	Raised Edge - Square	1	56
CS45BC	Raised Edge - Square	1	56
CS4AB	Raised Edge - Square	1	52
CS4BC	Raised Edge - Square	1	52
CS4GAB	Raised Edge - Square	1	56
CS4GBC	Raised Edge - Square	1	56
CS5AAB	Raised Edge - Square	1	51
CS5ABC	Raised Edge - Square	1	51
CS5ABCG	Raised Edge - Square	1	51
CS5ABCW	Raised Edge - Square	1	51
CS63AB	Raised Edge - Square	1	54
CS63BC	Raised Edge - Square	1	54
CS63FAB	Raised Edge - Square	1	54
CS63FBC	Raised Edge - Square	1	54
CS63NAB	Raised Edge - Square	1	54
CS63NBC	Raised Edge - Square	1	54
CS6AB	Raised Edge - Square	1	54

C.

Code	Catalogue Section	Qty	Page
CS6BC	Raised Edge - Square	1	54
CS73AB	Raised Edge - Square	1	56
CS73BC	Raised Edge - Square	1	56
CS74AB	Raised Edge - Square	1	56
CS74BC	Raised Edge - Square	1	56
CS7AB	Raised Edge - Square	1	50
CS7BC	Raised Edge - Square	1	50
CS7BCG	Raised Edge - Square	1	50
CS7BCW	Raised Edge - Square	1	50
CS7USB4BC	Raised Edge - Square	1	49
CS7USB4BCG	Raised Edge - Square	1	49
CS7USB4BCW	Raised Edge - Square	1	49
CS81NAB	Raised Edge - Square	1	55
CS81NBC	Raised Edge - Square	1	55
CS82NAB	Raised Edge - Square	1	55
CS82NBC	Raised Edge - Square	1	55
CS8333UBC	Raised Edge - Square	1	49
CS8333UBCG	Raised Edge - Square	1	49
CS8333UBCW	Raised Edge - Square	1	49
CS834AB	Raised Edge - Square	1	55
CS834BC	Raised Edge - Square	1	55
CS834FAB	Raised Edge - Square	1	54
CS834FBC	Raised Edge - Square	1	54
CS834NAB	Raised Edge - Square	1	54
CS834NBC	Raised Edge - Square	1	54
CS83AB	Raised Edge - Square	1	55
CS83BC	Raised Edge - Square	1	55
CS83BCG	Raised Edge - Square	1	55
CS83BCW	Raised Edge - Square	1	55
CS85AB	Raised Edge - Square	1	57
CS85BC	Raised Edge - Square	1	57
CS86AB	Raised Edge - Square	1	57
CS86BC	Raised Edge - Square	1	57
CS89AB	Raised Edge - Square	1	51
CS89BC	Raised Edge - Square	1	51
CS89BCG	Raised Edge - Square	1	51
CS89BCW	Raised Edge - Square	1	51
CS9124AB	Raised Edge - Square	1	50
CS9124BC	Raised Edge - Square	1	50
CS9124BCG	Raised Edge - Square	1	50
CS9124BCW	Raised Edge - Square	1	50
CS9224AB	Raised Edge - Square	1	48
CS9224BC	Raised Edge - Square	1	48
CS9224BCG	Raised Edge - Square	1	48
CS9224BCW	Raised Edge - Square	1	48
CS9905BC	Raised Edge - Square	1	49
CS9905BCG	Raised Edge - Square	1	49
CS9905BCW	Raised Edge - Square	1	49
CS9909BC	Raised Edge - Square	1	48
CS9909BCG	Raised Edge - Square	1	48
CS9909BCW	Raised Edge - Square	1	48
CS9AB	Raised Edge - Square	1	48
CS9BC	Raised Edge - Square	1	48
CS9BCG	Raised Edge - Square	1	48
CS9BCW	Raised Edge - Square	1	48
CSBLUEBC	Raised Edge - Square	1	50

C.				C.			
Code	Catalogue Section	Qty	Page	Code	Catalogue Section	Qty	Page
CSCREW35	Moulded Square Edge	100	13	CU2DIM	Moulded Curved Edge	1	21
CSCREW50	Moulded Square Edge	100	13	CU2G	Moulded Curved Edge	1	25
C-SCREW50B	Flat Plate	100	85	CU3000	Moulded Curved Edge	1	21
C-SCREW50BK	Flat Plate	100	85	CU4000	Moulded Curved Edge	1	21
C-SCREW50N	Flat Plate	100	85	CU4100	Moulded Curved Edge	1	21
CSCREW75	Moulded Square Edge	100	13	CU4101	Moulded Curved Edge	1	21
CSP1AB	Ceiling & Wall Lights	1	254	CU4200	Moulded Curved Edge	1	21
CSP1BC	Ceiling & Wall Lights	1	254	CU4G	Moulded Curved Edge	1	25
CSP1MB	Ceiling & Wall Lights	1	254	CU5U	Moulded Curved Edge	1	21
CSP2AB	Ceiling & Wall Lights	1	254	CU6000	Moulded Curved Edge	1	22
CSP2BC	Ceiling & Wall Lights	1	254	CU6000-3A	Moulded Curved Edge	1	22
CSP2MB	Ceiling & Wall Lights	1	254	CU6000N	Moulded Curved Edge	1	22
CSP3AB	Ceiling & Wall Lights	1	255	CU6300	Moulded Curved Edge	1	22
CSP3BC	Ceiling & Wall Lights	1	255	CU6300F	Moulded Curved Edge	1	22
CSP3MB	Ceiling & Wall Lights	1	255	CU6300N	Moulded Curved Edge	1	22
CSP4AB	Ceiling & Wall Lights	1	255	CU7000	Moulded Curved Edge	1	20
CSP4BC	Ceiling & Wall Lights	1	255	CU7000S	Moulded Curved Edge	1	20
CSP4MB	Ceiling & Wall Lights	1	255	CU7000U	Moulded Curved Edge	1	20
CSQUADBC	Raised Edge - Square	1	50	CU7300	Moulded Curved Edge	1	25
CSQUADBCG	Raised Edge - Square	1	50	CU7400	Moulded Curved Edge	1	25
CSQUADBCW	Raised Edge - Square	1	50	CU8331	Moulded Curved Edge	1	23
CSTOG12AB	Raised Edge - Square	1	53	CU8331N	Moulded Curved Edge	1	23
CSTOG12BC	Raised Edge - Square	1	53	CU8331NW	Moulded Curved Edge	1	23
CSTOG1AB	Raised Edge - Square	1	53	CU8331W	Moulded Curved Edge	1	23
CSTOG1BC	Raised Edge - Square	1	53	CU8332	Moulded Curved Edge	1	23
CSTOG2AB	Raised Edge - Square	1	53	CU8332N	Moulded Curved Edge	1	23
CSTOG2BC	Raised Edge - Square	1	53	CU8332NW	Moulded Curved Edge	1	23
CSTOG3AB	Raised Edge - Square	1	53	CU8332W	Moulded Curved Edge	1	23
CSTOG3BC	Raised Edge - Square	1	53	CU8333	Moulded Curved Edge	1	23
CSTOG4AB	Raised Edge - Square	1	53	CU8333N	Moulded Curved Edge	1	23
CSTOG4BC	Raised Edge - Square	1	53	CU8333NW	Moulded Curved Edge	1	23
CU0100	Moulded Curved Edge	1	25	CU8333W	Moulded Curved Edge	1	23
CU0110	Moulded Curved Edge	1	25	CU8340	Moulded Curved Edge	1	23
CU0120	Moulded Curved Edge	1	25	CU8341	Moulded Curved Edge	1	23
CU0140	Moulded Curved Edge	1	25	CU8341N	Moulded Curved Edge	1	23
CU0150	Moulded Curved Edge	1	25	CU8342	Moulded Curved Edge	1	23
CU1000	Moulded Curved Edge	1	21	CU8350	Moulded Curved Edge	1	25
CU1100	Moulded Curved Edge	1	20	CU8360	Moulded Curved Edge	1	25
CU1200	Moulded Curved Edge	1	21	CU8900N	Moulded Curved Edge	1	20
CU1200M	Moulded Curved Edge	1	21	CU9000	Moulded Curved Edge	1	18
CU1300	Moulded Curved Edge	10	25	CU9000S	Moulded Curved Edge	1	18
CU1400	Moulded Curved Edge	10	25	CU9000U	Moulded Curved Edge	1	18
CU1500	Moulded Curved Edge	5	25	CU9001	Moulded Curved Edge	1	18
CU1600	Moulded Curved Edge	5	25	CU9002	Moulded Curved Edge	1	19
CU1610	Moulded Curved Edge	10	25	CU9903	Moulded Curved Edge	1	20
CU1700	Moulded Curved Edge	10	25	CU9904	Moulded Curved Edge	1	19
CU1800	Moulded Curved Edge	5	25	CU9909	Moulded Curved Edge	1	18
CU194MM	Moulded Curved Edge	1	24	CU9948	Moulded Curved Edge	1	19
CU1DIM	Moulded Curved Edge	1	21	CU9KW	Moulded Curved Edge	1	18
CU1G	Moulded Curved Edge	1	25	CU9RCD	Moulded Curved Edge	1	18
CU2000	Moulded Curved Edge	1	21	CU9RCD	Moulded Curved Edge	1	22
CU2161	Moulded Curved Edge	1	21	CUBOIL	Moulded Curved Edge	1	27
CU2162	Moulded Curved Edge	1	21	CUBOOST	Moulded Curved Edge	1	27
CU2163	Moulded Curved Edge	1	21	CUCOFF	Moulded Curved Edge	1	27
CU2164	Moulded Curved Edge	1	21	CUDISH	Moulded Curved Edge	1	27
CU298MM	Moulded Curved Edge	1	24	CUDRY	Moulded Curved Edge	1	27

C.

Code	Catalogue Section	Qty	Page
CUFAN	Moulded Curved Edge	1	27
CUFREEZER	Moulded Curved Edge	1	27
CUFRID	Moulded Curved Edge	1	27
CUFRIDGE	Moulded Curved Edge	1	27
CUG1	Moulded Curved Edge	1	26
CUG12	Moulded Curved Edge	1	26
CUG1F	Moulded Curved Edge	1	26
CUG2	Moulded Curved Edge	1	26
CUG2F	Moulded Curved Edge	1	26
CUG3	Moulded Curved Edge	1	26
CUG4	Moulded Curved Edge	1	26
CUG6	Moulded Curved Edge	1	26
CUG8	Moulded Curved Edge	1	26
CUGM1	Moulded Curved Edge	1	26
CUGM10	Moulded Curved Edge	1	26
CUGM11	Moulded Curved Edge	1	27
CUGM12	Moulded Curved Edge	1	27
CUGM13	Moulded Curved Edge	1	27
CUGM14	Moulded Curved Edge	1	26
CUGM15	Moulded Curved Edge	1	27
CUGM16	Moulded Curved Edge	1	27
CUGM17	Moulded Curved Edge	1	27
CUGM2	Moulded Curved Edge	1	26
CUGM23	Moulded Curved Edge	1	26
CUGM3	Moulded Curved Edge	1	26
CUGM4	Moulded Curved Edge	1	26
CUGM5	Moulded Curved Edge	1	26
CUGM6	Moulded Curved Edge	1	26
CUGM7	Moulded Curved Edge	1	27
CUGM8	Moulded Curved Edge	1	27
CUGM9	Moulded Curved Edge	1	27
CUHOB	Moulded Curved Edge	1	27
CUHOOD	Moulded Curved Edge	1	27
CUMICRO	Moulded Curved Edge	1	27
CUOVEN	Moulded Curved Edge	1	27
CUWARM	Moulded Curved Edge	1	27
CUWASH	Moulded Curved Edge	1	27
CUWASTE	Moulded Curved Edge	1	27
CUWINE	Moulded Curved Edge	1	27

D.

Code	Catalogue Section	Qty	Page
DC010	Wireless Door Chimes	1	190
DC012	Wireless Door Chimes	1	191
DC013	Wireless Door Chimes	1	191
DC014	Wireless Door Chimes	1	191
DC015	Wireless Door Chimes	1	191
DCBPB	Wireless Door Chimes	1	190
DCBPW	Wireless Door Chimes	1	190
DCRB	Wireless Door Chimes	1	191
DCRW	Wireless Door Chimes	1	191

E.

Code	Catalogue Section	Qty	Page
E27PC	Bulkheads & Wall Packs	1	381
E27PR	Bulkheads & Wall Packs	1	381
EMEXIT	Emergency	1	434
EMEXITL2	Emergency	1	435

E.

Code	Catalogue Section	Qty	Page
EMEXITL3	Emergency	1	435
EMEXITLR	Emergency	1	435
EMGUKIT1	Downlights	1	222
EMGUKIT1	Emergency	1	439
EMKIT2	Emergency	1	439
EMLED1	Emergency	1	430
EMLED2A	Emergency	1	431
EMLED3	Emergency	1	430
EMLED4	Emergency	1	430
EMLED5	Emergency	1	431
EMLREC	Emergency	1	435
EMLSUS	Emergency	1	435
EMPDL	Emergency	1	438
EMPOWER2	Emergency	1	437
EMPOWER3	Emergency	1	436
EMPOWERST	Emergency	1	436
EMPOWERW2	Emergency	1	437
EMRNST	Emergency	1	432
EMRUN	Emergency	1	432
EMRUND	Emergency	1	432
EMRUNL	Emergency	1	432
EMRUNR	Emergency	1	432
EMRUNU	Emergency	1	432
EMSUR	Emergency	1	438
EMSWING	Emergency	1	433
EMSWINGD	Emergency	1	433
EMSWINGLR	Emergency	1	433
EMTWIN	Emergency	1	429
EMTWINIP	Emergency	1	428
EMTWINPC	Emergency	1	429
EMTWINST	Emergency	1	428
EMXST	Emergency	1	434
ENM5	Emergency	1	437
EVOABF	Downlights	1	230
EVOABT	Downlights	1	231
EVOBCF	Downlights	1	230
EVOBCT	Downlights	1	231
EVOBKF	Downlights	1	230
EVOBKT	Downlights	1	231
EVOBRF	Downlights	1	230
EVOBRT	Downlights	1	231
EVOCBC	Downlights	1	230
EVOCC	Downlights	1	230
EVOCHF	Downlights	1	230
EVOCHT	Downlights	1	231
EVOCW	Downlights	1	230
EVOGMF	Downlights	1	230
EVOGMT	Downlights	1	231
EVOICF	Downlights	1	230
EVOICT	Downlights	1	231
EVOIPBC	Downlights	1	230
EVOIPCH	Downlights	1	230
EVOIPWH	Downlights	1	230
EVOWHF	Downlights	1	230
EVOWHT	Downlights	1	231
EX001T	Ventilation	1	193



E.

Code	Catalogue Section	Qty	Page
EX003T	Ventilation	1	192
EX004H	Ventilation	1	192
EX004T	Ventilation	1	192
EX005T	Ventilation	1	192
EX006T	Ventilation	1	192
EX007B	Ventilation	1	193
EX007W	Ventilation	1	193
EX009B	Ventilation	1	193
EX009W	Ventilation	1	193
EX4DUCT	Ventilation	1	193
EXBDCKIT	Ventilation	1	193
EXBDWKIT	Ventilation	1	193
EXT2	Spike Lights	1	341
EXT3	Spike Lights	1	341

F.

Code	Catalogue Section	Qty	Page
FL16BK	Floodlights & Heating	1	362
FL16W	Floodlights & Heating	1	362
FL8BK	Floodlights & Heating	1	362
FL8W	Floodlights & Heating	1	362
FLEXCON	LED Flex	1	303
FLEXFIX	LED Flex	1	303
FLEXFIXL	LED Flex	1	303
FLF10R6B	Floodlights & Heating	1	361
FLF20R6B	Floodlights & Heating	1	361
FLF30R6B	Floodlights & Heating	1	361
FLF50R6B	Floodlights & Heating	1	361
FLN10	Floodlights & Heating	1	359
FLN20	Floodlights & Heating	1	359
FLN30	Floodlights & Heating	1	359
FLN50	Floodlights & Heating	1	359
FLNMIC	Floodlights & Heating	1	359
FLNPIR	Floodlights & Heating	1	359
FLP100	Floodlights & Heating	1	360
FLP100A	Floodlights & Heating	1	360
FLP150	Floodlights & Heating	1	360
FLP150A	Floodlights & Heating	1	360
FLP200	Floodlights & Heating	1	360
FLP200A	Floodlights & Heating	1	360
FLTB	Floodlights & Heating	1	363
FLTPB	Floodlights & Heating	1	363
FLTPW	Floodlights & Heating	1	363
FLTW	Floodlights & Heating	1	363
FP0100BB	Flat Plate	1	82
FP0100BC	Flat Plate	1	82
FP0100GM	Flat Plate	1	82
FP0100PB	Flat Plate	1	82
FP0100PC	Flat Plate	1	82
FP0100PL	Flat Plate	1	82
FP0140BB	Flat Plate	1	83
FP0140BC	Flat Plate	1	83
FP0140GM	Flat Plate	1	83
FP0140PB	Flat Plate	1	83
FP0140PC	Flat Plate	1	83
FP0140PL	Flat Plate	1	83
FP0150BB	Flat Plate	1	83

F.

Code	Catalogue Section	Qty	Page
FP0150BC	Flat Plate	1	83
FP0150GM	Flat Plate	1	83
FP0150PB	Flat Plate	1	83
FP0150PC	Flat Plate	1	83
FP0150PL	Flat Plate	1	83
FP0160BB	Flat Plate	1	82
FP0160BC	Flat Plate	1	82
FP0160GM	Flat Plate	1	82
FP0160PB	Flat Plate	1	82
FP0160PC	Flat Plate	1	82
FP0160PL	Flat Plate	1	82
FP1100BB	Flat Plate	1	73
FP1100BC	Flat Plate	1	73
FP1100GM	Flat Plate	1	73
FP1100PB	Flat Plate	1	73
FP1100PC	Flat Plate	1	73
FP1100PL	Flat Plate	1	73
FP1200BB	Flat Plate	1	74
FP1200BC	Flat Plate	1	74
FP1200GM	Flat Plate	1	74
FP1200PB	Flat Plate	1	74
FP1200PC	Flat Plate	1	74
FP1200PL	Flat Plate	1	74
FP12TOG6B	Flat Plate	1	76
FP12TOG6C	Flat Plate	1	76
FP12TOG6GM	Flat Plate	1	76
FP12TOG6PB	Flat Plate	1	76
FP12TOG6PC	Flat Plate	1	76
FP12TOG6PL	Flat Plate	1	76
FP16BB	Flat Plate	1	84
FP16BC	Flat Plate	1	84
FP16GM	Flat Plate	1	84
FP16PB	Flat Plate	1	84
FP16PC	Flat Plate	1	84
FP16PL	Flat Plate	1	84
FP1TOG6B	Flat Plate	1	76
FP1TOG6C	Flat Plate	1	76
FP1TOG6GM	Flat Plate	1	76
FP1TOG6PB	Flat Plate	1	76
FP1TOG6PC	Flat Plate	1	76
FP1TOG6PL	Flat Plate	1	76
FP2000BB	Flat Plate	1	74
FP2000BC	Flat Plate	1	74
FP2000GM	Flat Plate	1	74
FP2000PB	Flat Plate	1	74
FP2000PC	Flat Plate	1	74
FP2000PL	Flat Plate	1	74
FP2181BB	Flat Plate	1	77
FP2181BC	Flat Plate	1	77
FP2181GM	Flat Plate	1	77
FP2181PB	Flat Plate	1	77
FP2181PC	Flat Plate	1	77
FP2181PL	Flat Plate	1	77
FP2182BB	Flat Plate	1	77
FP2182BC	Flat Plate	1	77
FP2182GM	Flat Plate	1	77



F.

Code	Catalogue Section	Qty	Page
FP2182PB	Flat Plate	1	77
FP2182PC	Flat Plate	1	77
FP2182PL	Flat Plate	1	77
FP2183BB	Flat Plate	1	77
FP2183BC	Flat Plate	1	77
FP2183GM	Flat Plate	1	77
FP2183PB	Flat Plate	1	77
FP2183PC	Flat Plate	1	77
FP2183PL	Flat Plate	1	77
FP2184BB	Flat Plate	1	77
FP2184BC	Flat Plate	1	77
FP2184GM	Flat Plate	1	77
FP2184PB	Flat Plate	1	77
FP2184PC	Flat Plate	1	77
FP2184PL	Flat Plate	1	77
FP2GBB	Flat Plate	1	84
FP2GBC	Flat Plate	1	84
FP2GGM	Flat Plate	1	84
FP2GPB	Flat Plate	1	84
FP2GPC	Flat Plate	1	84
FP2GPL	Flat Plate	1	84
FP2TOGBB	Flat Plate	1	76
FP2TOGBC	Flat Plate	1	76
FP2TOGGM	Flat Plate	1	76
FP2TOGPB	Flat Plate	1	76
FP2TOGPC	Flat Plate	1	76
FP2TOGPL	Flat Plate	1	76
FP3000BB	Flat Plate	1	75
FP3000BC	Flat Plate	1	75
FP3000GM	Flat Plate	1	75
FP3000PB	Flat Plate	1	75
FP3000PC	Flat Plate	1	75
FP3000PL	Flat Plate	1	75
FP3TOGBB	Flat Plate	1	76
FP3TOGBC	Flat Plate	1	76
FP3TOGGM	Flat Plate	1	76
FP3TOGPB	Flat Plate	1	76
FP3TOGPC	Flat Plate	1	76
FP3TOGPL	Flat Plate	1	76
FP4000BB	Flat Plate	1	75
FP4000BC	Flat Plate	1	75
FP4000GM	Flat Plate	1	75
FP4000PB	Flat Plate	1	75
FP4000PC	Flat Plate	1	75
FP4000PL	Flat Plate	1	75
FP4100BB	Flat Plate	1	75
FP4100BC	Flat Plate	1	75
FP4100GM	Flat Plate	1	75
FP4100PB	Flat Plate	1	75
FP4100PC	Flat Plate	1	75
FP4100PL	Flat Plate	1	75
FP4200BB	Flat Plate	1	75
FP4200BC	Flat Plate	1	75
FP4200GM	Flat Plate	1	75
FP4200PB	Flat Plate	1	75
FP4200PC	Flat Plate	1	75

F.

Code	Catalogue Section	Qty	Page
FP4200PL	Flat Plate	1	75
FP4GBB	Flat Plate	1	84
FP4GBC	Flat Plate	1	84
FP4GGM	Flat Plate	1	84
FP4GPB	Flat Plate	1	84
FP4GPC	Flat Plate	1	84
FP4GPL	Flat Plate	1	84
FP4TOGBB	Flat Plate	1	76
FP4TOGBC	Flat Plate	1	76
FP4TOGGM	Flat Plate	1	76
FP4TOGPB	Flat Plate	1	76
FP4TOGPC	Flat Plate	1	76
FP4TOGPL	Flat Plate	1	76
FP5ABB	Flat Plate	1	73
FP5ABC	Flat Plate	1	73
FP5ABCG	Flat Plate	1	73
FP5ABCW	Flat Plate	1	73
FP5AGM	Flat Plate	1	73
FP5APB	Flat Plate	1	73
FP5APC	Flat Plate	1	73
FP5APCG	Flat Plate	1	73
FP5APCW	Flat Plate	1	73
FP5APLW	Flat Plate	1	73
FP6000BB	Flat Plate	1	78
FP6000BC	Flat Plate	1	78
FP6000GM	Flat Plate	1	78
FP6000NGM	Flat Plate	1	79
FP6000NPB	Flat Plate	1	79
FP6000NPC	Flat Plate	1	79
FP6000NPL	Flat Plate	1	79
FP6000PB	Flat Plate	1	78
FP6000PC	Flat Plate	1	78
FP6000PL	Flat Plate	1	78
FP6300BB	Flat Plate	1	79
FP6300BC	Flat Plate	1	79
FP6300FBB	Flat Plate	1	79
FP6300FBC	Flat Plate	1	79
FP6300FGM	Flat Plate	1	79
FP6300FPB	Flat Plate	1	79
FP6300FPC	Flat Plate	1	79
FP6300FPL	Flat Plate	1	79
FP6300GM	Flat Plate	1	79
FP6300NBB	Flat Plate	1	78
FP6300NBC	Flat Plate	1	78
FP6300NGM	Flat Plate	1	78
FP6300NPB	Flat Plate	1	78
FP6300NPC	Flat Plate	1	78
FP6300NPL	Flat Plate	1	78
FP6300PB	Flat Plate	1	79
FP6300PC	Flat Plate	1	79
FP6300PL	Flat Plate	1	79
FP7300BB	Flat Plate	1	82
FP7300BC	Flat Plate	1	82
FP7300GM	Flat Plate	1	82
FP7300PB	Flat Plate	1	82
FP7300PC	Flat Plate	1	82

F.				F.			
Code	Catalogue Section	Qty	Page	Code	Catalogue Section	Qty	Page
FP7300PL	Flat Plate	1	82	FP8900PCG	Flat Plate	1	72
FP7400BB	Flat Plate	1	82	FP8900PCW	Flat Plate	1	72
FP7400BC	Flat Plate	1	82	FP8900PLW	Flat Plate	1	72
FP7400GM	Flat Plate	1	82	FPQUADBB	Flat Plate	1	71
FP7400PB	Flat Plate	1	82	FPQUADBC	Flat Plate	1	71
FP7400PC	Flat Plate	1	82	FPQUADBCG	Flat Plate	1	71
FP7400PL	Flat Plate	1	82	FPQUADBCW	Flat Plate	1	71
FP8331NBB	Flat Plate	1	81	FPQUADGM	Flat Plate	1	71
FP8331NBC	Flat Plate	1	81	FPQUADPB	Flat Plate	1	71
FP8331NGM	Flat Plate	1	81	FPQUADPC	Flat Plate	1	71
FP8331NPB	Flat Plate	1	81	FPQUADPCG	Flat Plate	1	71
FP8331NPC	Flat Plate	1	81	FPQUADPCW	Flat Plate	1	71
FP8331NPL	Flat Plate	1	81	FPQUADPLW	Flat Plate	1	71
FP8332NBB	Flat Plate	1	81	FPR7000BB	Flat Plate	1	70
FP8332NBC	Flat Plate	1	81	FPR7000BC	Flat Plate	1	70
FP8332NGM	Flat Plate	1	81	FPR7000BCG	Flat Plate	1	70
FP8332NPB	Flat Plate	1	81	FPR7000BCW	Flat Plate	1	70
FP8332NPC	Flat Plate	1	81	FPR7000GM	Flat Plate	1	70
FP8332NPL	Flat Plate	1	81	FPR7000PB	Flat Plate	1	70
FP8341BB	Flat Plate	1	80	FPR7000PC	Flat Plate	1	70
FP8341BC	Flat Plate	1	80	FPR7000PCG	Flat Plate	1	70
FP8341FBB	Flat Plate	1	80	FPR7000PCW	Flat Plate	1	70
FP8341FBC	Flat Plate	1	80	FPR7000PLW	Flat Plate	1	70
FP8341FGM	Flat Plate	1	80	FPR7UBBW	Flat Plate	1	71
FP8341FPB	Flat Plate	1	80	FPR7UBCW	Flat Plate	1	71
FP8341FPC	Flat Plate	1	80	FPR7UPBW	Flat Plate	1	71
FP8341FPL	Flat Plate	1	80	FPR7UPCW	Flat Plate	1	71
FP8341GM	Flat Plate	1	80	FPR7USB4BB	Flat Plate	1	69
FP8341NBB	Flat Plate	1	80	FPR7USB4BC	Flat Plate	1	69
FP8341NBC	Flat Plate	1	80	FPR7USB4BCG	Flat Plate	1	69
FP8341NGM	Flat Plate	1	80	FPR7USB4BCW	Flat Plate	1	69
FP8341NPB	Flat Plate	1	80	FPR7USB4GM	Flat Plate	1	69
FP8341NPC	Flat Plate	1	80	FPR7USB4PB	Flat Plate	1	69
FP8341NPL	Flat Plate	1	80	FPR7USB4PC	Flat Plate	1	69
FP8341PB	Flat Plate	1	80	FPR7USB4PCG	Flat Plate	1	69
FP8341PC	Flat Plate	1	80	FPR7USB4PCW	Flat Plate	1	69
FP8341PL	Flat Plate	1	80	FPR7USB4PLW	Flat Plate	1	69
FP8350BB	Flat Plate	1	83	FPR8333NBB	Flat Plate	1	81
FP8350BC	Flat Plate	1	83	FPR8333NBC	Flat Plate	1	81
FP8350GM	Flat Plate	1	83	FPR8333NBCG	Flat Plate	1	81
FP8350PB	Flat Plate	1	83	FPR8333NBCW	Flat Plate	1	81
FP8350PC	Flat Plate	1	83	FPR8333NGM	Flat Plate	1	81
FP8350PL	Flat Plate	1	83	FPR8333NPB	Flat Plate	1	81
FP8360BB	Flat Plate	1	83	FPR8333NPC	Flat Plate	1	81
FP8360BC	Flat Plate	1	83	FPR8333NPCG	Flat Plate	1	81
FP8360GM	Flat Plate	1	83	FPR8333NPCW	Flat Plate	1	81
FP8360PB	Flat Plate	1	83	FPR8333NPLW	Flat Plate	1	81
FP8360PC	Flat Plate	1	83	FPR9000BB	Flat Plate	1	66
FP8360PL	Flat Plate	1	83	FPR9000BC	Flat Plate	1	66
FP8900BB	Flat Plate	1	72	FPR9000BCG	Flat Plate	1	66
FP8900BC	Flat Plate	1	72	FPR9000BCW	Flat Plate	1	66
FP8900BCG	Flat Plate	1	72	FPR9000GM	Flat Plate	1	66
FP8900BCW	Flat Plate	1	72	FPR9000PB	Flat Plate	1	66
FP8900GM	Flat Plate	1	72	FPR9000PC	Flat Plate	1	66
FP8900PB	Flat Plate	1	72	FPR9000PCG	Flat Plate	1	66
FP8900PC	Flat Plate	1	72	FPR9000PCW	Flat Plate	1	66

F.

Code	Catalogue Section	Qty	Page
FPR9000PLW	Flat Plate	1	66
FPR9124BB	Flat Plate	1	70
FPR9124BC	Flat Plate	1	70
FPR9124BCG	Flat Plate	1	70
FPR9124BCW	Flat Plate	1	70
FPR9124GM	Flat Plate	1	70
FPR9124PB	Flat Plate	1	70
FPR9124PC	Flat Plate	1	70
FPR9124PCG	Flat Plate	1	70
FPR9124PCW	Flat Plate	1	70
FPR9124PLW	Flat Plate	1	70
FPR9224BB	Flat Plate	1	67
FPR9224BC	Flat Plate	1	67
FPR9224BCG	Flat Plate	1	67
FPR9224BCW	Flat Plate	1	67
FPR9224GM	Flat Plate	1	67
FPR9224PB	Flat Plate	1	67
FPR9224PC	Flat Plate	1	67
FPR9224PCG	Flat Plate	1	67
FPR9224PCW	Flat Plate	1	67
FPR9224PLW	Flat Plate	1	67
FPR9904NBC	Flat Plate	1	68
FPR9904NBCG	Flat Plate	1	68
FPR9904NBCW	Flat Plate	1	68
FPR9905BC	Flat Plate	1	69
FPR9905BCG	Flat Plate	1	69
FPR9905BCW	Flat Plate	1	69
FPR9UBBW	Flat Plate	1	71
FPR9UBCW	Flat Plate	1	71
FPR9UPBW	Flat Plate	1	71
FPR9UPCW	Flat Plate	1	71
FPRJ45BB	Flat Plate	1	82
FPRJ45BC	Flat Plate	1	82
FPRJ45GM	Flat Plate	1	82
FPRJ45PB	Flat Plate	1	82
FPRJ45PC	Flat Plate	1	82
FPRJ45PL	Flat Plate	1	82
FR1200	Recessed, Surface & Suspension	1	398
FR150	Downlights	1	222
FR600	Recessed, Surface & Suspension	1	398

G.

Code	Catalogue Section	Qty	Page
G4COB1	Lamps & Lighting Accessories	10	445
G4COB2	Lamps & Lighting Accessories	10	445
G4LED5	Lamps & Lighting Accessories	10	445
G4LED6	Lamps & Lighting Accessories	10	445
G5DCW	Lamps & Lighting Accessories	10	443
G5DWW	Lamps & Lighting Accessories	10	443
G9LED10	Lamps & Lighting Accessories	10	445
G9LED11	Lamps & Lighting Accessories	10	445
G9LED16	Lamps & Lighting Accessories	10	445
G9LED17	Lamps & Lighting Accessories	10	445
G9LED8	Lamps & Lighting Accessories	10	445
G9LED9	Lamps & Lighting Accessories	10	445
GBD4ESC	Lamps & Lighting Accessories	1	444
GBD4SESC	Lamps & Lighting Accessories	1	444

G.

Code	Catalogue Section	Qty	Page
GDBOILAT	Screwless	1	132
GDBOILBC	Flat Plate	1	87
GDBOILBN	Screwless	1	132
GDBOILMB	Screwless	1	132
GDBOILMW	Screwless	1	132
GDBOILPC	Flat Plate	1	87
GDBOILSB	Screwless	1	132
GDBOILU	Metal Clad	1	150
GDBOOSTAT	Screwless	1	132
GDBOOSTBC	Flat Plate	1	87
GDBOOSTBN	Screwless	1	132
GDBOOSTMB	Screwless	1	132
GDBOOSTMW	Screwless	1	132
GDBOOSTPC	Flat Plate	1	87
GDBOOSTSB	Screwless	1	132
GDCL12BC	Raised Edge - Rounded	1	41
GDCL1BC	Raised Edge - Rounded	1	41
GDCL1PC	Raised Edge - Rounded	1	41
GDCL2BC	Raised Edge - Rounded	1	41
GDCL2PC	Raised Edge - Rounded	1	41
GDCL3BC	Raised Edge - Rounded	1	41
GDCL3PC	Raised Edge - Rounded	1	41
GDCL4BC	Raised Edge - Rounded	1	41
GDCL4PC	Raised Edge - Rounded	1	41
GDCL6BC	Raised Edge - Rounded	1	41
GDCL6PC	Raised Edge - Rounded	1	41
GDCL8BC	Raised Edge - Rounded	1	41
GDCL8PC	Raised Edge - Rounded	1	41
GDCL9BC	Raised Edge - Rounded	1	41
GDCOFFAT	Screwless	1	132
GDCOFFBC	Flat Plate	1	87
GDCOFFBN	Screwless	1	132
GDCOFFMB	Screwless	1	132
GDCOFFMW	Screwless	1	132
GDCOFFPC	Flat Plate	1	87
GDCOFFSB	Screwless	1	132
GDCOFFU	Metal Clad	1	150
GDCOOKAT	Screwless	1	132
GDCOOKBC	Flat Plate	1	87
GDCOOKBN	Screwless	1	132
GDCOOKMB	Screwless	1	132
GDCOOKMW	Screwless	1	132
GDCOOKPC	Flat Plate	1	87
GDCOOKSB	Screwless	1	132
GDCOOKU	Metal Clad	1	150
GDCS12BC	Raised Edge - Square	1	58
GDCS1BC	Raised Edge - Square	1	58
GDCS2BC	Raised Edge - Square	1	58
GDCS3BC	Raised Edge - Square	1	58
GDCS4BC	Raised Edge - Square	1	58
GDCS6BC	Raised Edge - Square	1	58
GDCS8BC	Raised Edge - Square	1	58
GDCS9BC	Raised Edge - Square	1	58
GDDISHAT	Screwless	1	132
GDDISHBC	Flat Plate	1	87
GDDISHBN	Screwless	1	132

G.				G.			
Code	Catalogue Section	Qty	Page	Code	Catalogue Section	Qty	Page
GDDISHMB	Screwless	1	132	GDFRIDBC	Flat Plate	1	87
GDDISHMW	Screwless	1	132	GDFRIDBN	Screwless	1	132
GDDISHPC	Flat Plate	1	87	GDFRIDGEAT	Screwless	1	132
GDDISHSB	Screwless	1	132	GDFRIDGEBC	Flat Plate	1	87
GDDISHU	Metal Clad	1	150	GDFRIDGEBN	Screwless	1	132
GDDRYAT	Screwless	1	132	GDFRIDGEGB	Screwless	1	132
GDDRYBC	Flat Plate	1	87	GDFRIDGEMW	Screwless	1	132
GDDRYBN	Screwless	1	132	GDFRIDGEPC	Flat Plate	1	87
GDDRYMB	Screwless	1	132	GDFRIDGESE	Screwless	1	132
GDDRYMW	Screwless	1	132	GDFRIDGEU	Metal Clad	1	150
GDDRYPC	Flat Plate	1	87	GDFRIDMB	Screwless	1	132
GDDRYSB	Screwless	1	132	GDFRIDMW	Screwless	1	132
GDDRYU	Metal Clad	1	150	GDFRIDPC	Flat Plate	1	87
GDF001F	Raised Edge - Rounded	1	41	GDFRIDSB	Screwless	1	132
GDF002F	Raised Edge - Rounded	1	41	GDFRIDU	Metal Clad	1	150
GDFANAT	Screwless	1	132	GDHOBAT	Screwless	1	132
GDFANBC	Flat Plate	1	87	GDHOBBC	Flat Plate	1	87
GDFANBN	Screwless	1	132	GDHOBBN	Screwless	1	132
GDFANMB	Screwless	1	132	GDHOBMB	Screwless	1	132
GDFANMW	Screwless	1	132	GDHOBMW	Screwless	1	132
GDFANPC	Flat Plate	1	87	GDHOBPC	Flat Plate	1	87
GDFANSB	Screwless	1	132	GDHOBSE	Screwless	1	132
GDFANU	Metal Clad	1	150	GDHOBU	Metal Clad	1	150
GDFP0012M	Metal Clad	1	148	GDKEY	Moulded Curved Edge	1	27
GDFP001BC	Flat Plate	1	85	GDL2	Outdoor Wall Lights & Bollards	1	335
GDFP001M	Metal Clad	1	148	GDL3	Outdoor Wall Lights & Bollards	1	335
GDFP001PC	Flat Plate	1	85	GDLMK23	Outdoor Wall Lights & Bollards	1	335
GDFP002BC	Flat Plate	1	85	GDLSPKE2	Outdoor Wall Lights & Bollards	1	335
GDFP002M	Metal Clad	1	148	GDM001AT	Screwless	1	131
GDFP002PC	Flat Plate	1	85	GDM001BC	Flat Plate	1	86
GDFP003BC	Flat Plate	1	85	GDM001BN	Screwless	1	131
GDFP003M	Metal Clad	1	148	GDM001MB	Screwless	1	131
GDFP003PC	Flat Plate	1	85	GDM001MW	Screwless	1	131
GDFP004BC	Flat Plate	1	85	GDM001PC	Flat Plate	1	86
GDFP004M	Metal Clad	1	148	GDM001SE	Screwless	1	131
GDFP004PC	Flat Plate	1	85	GDM001U	Metal Clad	1	149
GDFP006BC	Flat Plate	1	85	GDM002AT	Screwless	1	131
GDFP006M	Metal Clad	1	148	GDM002BC	Flat Plate	1	86
GDFP006PC	Flat Plate	1	85	GDM002BN	Screwless	1	131
GDFP008BC	Flat Plate	1	85	GDM002MB	Screwless	1	131
GDFP008M	Metal Clad	1	148	GDM002MW	Screwless	1	131
GDFP008PC	Flat Plate	1	85	GDM002PC	Flat Plate	1	86
GDFP009BC	Flat Plate	1	85	GDM002SE	Screwless	1	131
GDFP009M	Metal Clad	1	148	GDM002U	Metal Clad	1	149
GDFP009PC	Flat Plate	1	85	GDM003AT	Screwless	1	131
GDFP012BC	Flat Plate	1	85	GDM003BC	Flat Plate	1	86
GDFP012PC	Flat Plate	1	85	GDM003BN	Screwless	1	131
GDFREEZERAT	Screwless	1	132	GDM003MB	Screwless	1	131
GDFREEZERBC	Flat Plate	1	87	GDM003MW	Screwless	1	131
GDFREEZERBN	Screwless	1	132	GDM003PC	Flat Plate	1	86
GDFREEZERMB	Screwless	1	132	GDM003SE	Screwless	1	131
GDFREEZERMW	Screwless	1	132	GDM003U	Metal Clad	1	149
GDFREEZERPC	Flat Plate	1	87	GDM004AT	Screwless	1	131
GDFREEZERSE	Screwless	1	132	GDM004BC	Flat Plate	1	86
GDFREEZERU	Metal Clad	1	150	GDM004BN	Screwless	1	131
GDFRIDAT	Screwless	1	132	GDM004MB	Screwless	1	131



G.

Code	Catalogue Section	Qty	Page
GDM004MW	Screwless	1	131
GDM004PC	Flat Plate	1	86
GDM004SB	Screwless	1	131
GDM004U	Metal Clad	1	149
GDM005AT	Screwless	1	131
GDM005BC	Flat Plate	1	86
GDM005BN	Screwless	1	131
GDM005MB	Screwless	1	131
GDM005MW	Screwless	1	131
GDM005PC	Flat Plate	1	86
GDM005SB	Screwless	1	131
GDM005U	Metal Clad	1	149
GDM006AT	Screwless	1	131
GDM006BC	Flat Plate	1	86
GDM006BN	Screwless	1	131
GDM006MB	Screwless	1	131
GDM006MW	Screwless	1	131
GDM006PC	Flat Plate	1	86
GDM006SB	Screwless	1	131
GDM006U	Metal Clad	1	149
GDM007AT	Screwless	1	131
GDM007BC	Flat Plate	1	86
GDM007BN	Screwless	1	131
GDM007MB	Screwless	1	131
GDM007MW	Screwless	1	131
GDM007PC	Flat Plate	1	86
GDM007SB	Screwless	1	131
GDM007U	Metal Clad	1	149
GDM008AT	Screwless	1	131
GDM008BC	Flat Plate	1	86
GDM008BN	Screwless	1	131
GDM008MB	Screwless	1	131
GDM008MW	Screwless	1	131
GDM008PC	Flat Plate	1	86
GDM008SB	Screwless	1	131
GDM008U	Metal Clad	1	149
GDM009AT	Screwless	1	131
GDM009BC	Flat Plate	1	86
GDM009BN	Screwless	1	131
GDM009MB	Screwless	1	131
GDM009MW	Screwless	1	131
GDM009PC	Flat Plate	1	86
GDM009SB	Screwless	1	131
GDM009U	Metal Clad	1	149
GDM010AT	Screwless	1	131
GDM010BC	Flat Plate	1	86
GDM010BN	Screwless	1	131
GDM010MB	Screwless	1	131
GDM010MW	Screwless	1	131
GDM010PC	Flat Plate	1	86
GDM010SB	Screwless	1	131
GDM010U	Metal Clad	1	149
GDM011AT	Screwless	1	132
GDM011BC	Flat Plate	1	87
GDM011BN	Screwless	1	132
GDM011MB	Screwless	1	132

G.

Code	Catalogue Section	Qty	Page
GDM011MW	Screwless	1	132
GDM011PC	Flat Plate	1	87
GDM011SB	Screwless	1	132
GDM011U	Metal Clad	1	150
GDM012AT	Screwless	1	132
GDM012BC	Flat Plate	1	87
GDM012BN	Screwless	1	132
GDM012MB	Screwless	1	132
GDM012MW	Screwless	1	132
GDM012PC	Flat Plate	1	87
GDM012SB	Screwless	1	132
GDM012U	Metal Clad	1	150
GDM013AT	Screwless	1	132
GDM013BC	Flat Plate	1	87
GDM013BN	Screwless	1	132
GDM013MB	Screwless	1	132
GDM013MW	Screwless	1	132
GDM013PC	Flat Plate	1	87
GDM013SB	Screwless	1	132
GDM013U	Metal Clad	1	150
GDM014AT	Screwless	1	131
GDM014BN	Screwless	1	131
GDM014MB	Screwless	1	131
GDM014MW	Screwless	1	131
GDM014PC	Flat Plate	1	86
GDM014SB	Screwless	1	131
GDM014U	Metal Clad	1	150
GDM016AT	Screwless	1	132
GDM016BC	Flat Plate	1	87
GDM016BN	Screwless	1	132
GDM016MB	Screwless	1	132
GDM016MW	Screwless	1	132
GDM016PC	Flat Plate	1	87
GDM016SB	Screwless	1	132
GDM016U	Metal Clad	1	150
GDM017	Flat Plate	1	87
GDM018	Flat Plate	1	87
GDM019	Flat Plate	1	87
GDM020AT	Screwless	1	131
GDM020BC	Flat Plate	1	87
GDM020BN	Screwless	1	131
GDM020MB	Screwless	1	131
GDM020MW	Screwless	1	131
GDM020PC	Flat Plate	1	87
GDM020SB	Screwless	1	131
GDM020U	Metal Clad	1	149
GDM021AT	Screwless	1	131
GDM021BC	Flat Plate	1	87
GDM021BN	Screwless	1	131
GDM021MB	Screwless	1	131
GDM021MW	Screwless	1	131
GDM021PC	Flat Plate	1	87
GDM021SB	Screwless	1	131
GDM021U	Metal Clad	1	149
GDM022AT	Screwless	1	132
GDM022BC	Flat Plate	1	87

G.				G.			
Code	Catalogue Section	Qty	Page	Code	Catalogue Section	Qty	Page
GDM022BN	Screwless	1	132	GDSF004BN	Screwless	1	130
GDM022MB	Screwless	1	132	GDSF004MB	Screwless	1	130
GDM022MW	Screwless	1	132	GDSF004MW	Screwless	1	130
GDM022PC	Flat Plate	1	87	GDSF004PC	Screwless	1	130
GDM022SB	Screwless	1	132	GDSF004SB	Screwless	1	130
GDM022U	Metal Clad	1	150	GDSF006AT	Screwless	1	130
GDM200AT	Screwless	1	131	GDSF006BC	Screwless	1	130
GDM200BN	Screwless	1	131	GDSF006BN	Screwless	1	130
GDM200MB	Screwless	1	131	GDSF006MB	Screwless	1	130
GDM200MW	Screwless	1	131	GDSF006MW	Screwless	1	130
GDM200PC	Flat Plate	1	86	GDSF006PC	Screwless	1	130
GDM200SB	Screwless	1	131	GDSF006SB	Screwless	1	130
GDM200U	Metal Clad	1	150	GDSF008AT	Screwless	1	130
GDMICROAT	Screwless	1	132	GDSF008BC	Screwless	1	130
GDMICROBC	Flat Plate	1	87	GDSF008BN	Screwless	1	130
GDMICROBN	Screwless	1	132	GDSF008MB	Screwless	1	130
GDMICROMB	Screwless	1	132	GDSF008MW	Screwless	1	130
GDMICROMW	Screwless	1	132	GDSF008PC	Screwless	1	130
GDMICROPC	Flat Plate	1	87	GDSF008SB	Screwless	1	130
GDMICROSB	Screwless	1	132	GDSF009AT	Screwless	1	130
GDMICROU	Metal Clad	1	150	GDSF009BC	Screwless	1	130
GDOVENAT	Screwless	1	132	GDSF009BN	Screwless	1	130
GDOVENBC	Flat Plate	1	87	GDSF009MW	Screwless	1	130
GDOVENBN	Screwless	1	132	GDSF009PC	Screwless	1	130
GDOVENMB	Screwless	1	132	GDSF009SB	Screwless	1	130
GDOVENMW	Screwless	1	132	GDSF012AT	Screwless	1	130
GDOVENPC	Flat Plate	1	87	GDSF012BC	Screwless	1	130
GDOVENSB	Screwless	1	132	GDSF012BN	Screwless	1	130
GDOVENU	Metal Clad	1	150	GDSF012MW	Screwless	1	130
GDS001F	Screwless	1	130	GDSF012PC	Screwless	1	130
GDS002F	Screwless	1	130	GDSF012SB	Screwless	1	130
GDS003F	Screwless	1	130	GDSG68G	Wiring Basics	1	178
GDS004F	Screwless	1	130	GDSG68M	Metal Clad	1	149
GDSF001AT	Screwless	1	130	GDSG912G	Wiring Basics	1	178
GDSF001BC	Screwless	1	130	GDSG912M	Metal Clad	1	149
GDSF001BN	Screwless	1	130	GDWARMAT	Screwless	1	132
GDSF001MB	Screwless	1	130	GDWARMBC	Flat Plate	1	87
GDSF001MW	Screwless	1	130	GDWARMBN	Screwless	1	132
GDSF001PC	Screwless	1	130	GDWARMMB	Screwless	1	132
GDSF001SB	Screwless	1	130	GDWARMMW	Screwless	1	132
GDSF002AT	Screwless	1	130	GDWARMPC	Flat Plate	1	87
GDSF002BC	Screwless	1	130	GDWARMMSB	Screwless	1	132
GDSF002BN	Screwless	1	130	GDWARMU	Metal Clad	1	150
GDSF002MB	Screwless	1	130	GDWASHAT	Screwless	1	132
GDSF002MW	Screwless	1	130	GDWASHBC	Flat Plate	1	87
GDSF002PC	Screwless	1	130	GDWASHBN	Screwless	1	132
GDSF002SB	Screwless	1	130	GDWASHMB	Screwless	1	132
GDSF003AT	Screwless	1	130	GDWASHMW	Screwless	1	132
GDSF003BC	Screwless	1	130	GDWASHPC	Flat Plate	1	87
GDSF003BN	Screwless	1	130	GDWASHSB	Screwless	1	132
GDSF003MB	Screwless	1	130	GDWASHU	Metal Clad	1	150
GDSF003MW	Screwless	1	130	GDWASTEAT	Screwless	1	132
GDSF003PC	Screwless	1	130	GDWASTEBC	Flat Plate	1	87
GDSF003SB	Screwless	1	130	GDWASTEBN	Screwless	1	132
GDSF004AT	Screwless	1	130	GDWASTE MB	Screwless	1	132
GDSF004BC	Screwless	1	130	GDWASTE MW	Screwless	1	132

G.

Code	Catalogue Section	Qty	Page
GDWASTEPC	Flat Plate	1	87
GDWASTESB	Screwless	1	132
GDWASTEU	Metal Clad	1	150
GDWINEAT	Screwless	1	132
GDWINEBC	Flat Plate	1	87
GDWINEBN	Screwless	1	132
GDWINEMB	Screwless	1	132
GDWINEMW	Screwless	1	132
GDWINEPC	Flat Plate	1	87
GDWINESB	Screwless	1	132
GDWINEU	Metal Clad	1	150
GLS9BCKW	Smart Home	1	212
GLS9ESKW	Smart Home	1	212
GLSD8BCC	Lamps & Lighting Accessories	1	444
GLSD8ESC	Lamps & Lighting Accessories	1	444
GROUND2	Outdoor Wall Lights & Bollards	1	312
GSE225	Wiring Basics	5	178
GSE25	Wiring Basics	10	178
GSK16	Wiring Basics	20	178
GSK194MM	Moulded Curved Edge	1	24
GSK194MM	Screwless	1	125
GSK225	Wiring Basics	5	178
GSK235	Wiring Basics	5	178
GSK235D	Wiring Basics	5	178
GSK247	Wiring Basics	5	178
GSK25	Wiring Basics	10	178
GSK27	Wiring Basics	20	178
GSK298MM	Moulded Curved Edge	1	24
GSK298MM	Wiring Basics	1	178
GSK335	Wiring Basics	5	178
GSK335D	Screwless	1	121
GSK335D	Screwless	1	126
GSK335D	Wiring Basics	5	178
GSK35	Wiring Basics	10	178
GSK47	Wiring Basics	10	178
GU10SPIKE	Spike Lights	1	338
GU10SPIKEBK	Spike Lights	1	338
GU10SPIKEL	Spike Lights	1	339
GU5KW	Smart Home	1	212
GU5LCW	Lamps & Lighting Accessories	20	443
GU5LDCW	Lamps & Lighting Accessories	20	443
GU5LDDL	Lamps & Lighting Accessories	20	443
GU5LDL	Lamps & Lighting Accessories	20	443
GU5LDWW	Lamps & Lighting Accessories	20	443
GU5LWW	Lamps & Lighting Accessories	20	443
GUSM5CW	Lamps & Lighting Accessories	20	443
GUSM5DL	Lamps & Lighting Accessories	20	443
GUSM5WW	Lamps & Lighting Accessories	20	443
GUSPBK	Spike Lights	1	341
GUSPGR	Spike Lights	1	341
GXLED3K	Lamps & Lighting Accessories	1	448
GXLED5K	Lamps & Lighting Accessories	1	448

H.

Code	Catalogue Section	Qty	Page
HBLU1	High Bay / Low Bay	1	423
HBLU2	High Bay / Low Bay	1	423

H.

Code	Catalogue Section	Qty	Page
HBN150	High Bay / Low Bay	1	422
HBN200	High Bay / Low Bay	1	422
HBNR1	High Bay / Low Bay	1	423
HBNR2	High Bay / Low Bay	1	423
HBNS1	High Bay / Low Bay	1	423
HCBC	Downlights	1	222
HCC	Downlights	1	222
HCW	Downlights	1	222
HEOD1309BK	Floodlights & Heating	1	366
HEOD1309W	Floodlights & Heating	1	366
HEOT1300W	Floodlights & Heating	1	366
HPLED1W	Groundlights & Deck Lighting	1	355
HS60MM	Wiring Basics	1	185
HS65MM	Wiring Basics	1	185
HS70MM	Wiring Basics	1	185
HS72MM	Wiring Basics	1	185
HS75MM	Wiring Basics	1	185
HS80MM	Wiring Basics	1	185
HS85MM	Wiring Basics	1	185
HS90MM	Wiring Basics	1	185
HSARBORL	Wiring Basics	1	185
HSARBORS	Wiring Basics	1	185
HSPILOTDB5	Wiring Basics	1	185

I.

Code	Catalogue Section	Qty	Page
ICEMC	Downlights	1	241
IN001	Industrial Switches & Sockets	1	188
IN0010	Industrial Switches & Sockets	1	188
IN0011	Industrial Switches & Sockets	1	188
IN0012	Industrial Switches & Sockets	1	188
IN0013	Industrial Switches & Sockets	1	188
IN0014	Industrial Switches & Sockets	1	189
IN0015	Industrial Switches & Sockets	1	189
IN0016	Industrial Switches & Sockets	1	189
IN0017	Industrial Switches & Sockets	1	189
IN0018	Industrial Switches & Sockets	1	189
IN0019	Industrial Switches & Sockets	1	189
IN002	Industrial Switches & Sockets	1	188
IN0020	Industrial Switches & Sockets	1	189
IN0021	Industrial Switches & Sockets	1	188
IN0022	Industrial Switches & Sockets	1	188
IN0023	Industrial Switches & Sockets	1	188
IN0025	Industrial Switches & Sockets	1	189
IN0026	Industrial Switches & Sockets	1	189
IN0027	Industrial Switches & Sockets	1	189
IN003	Industrial Switches & Sockets	1	188
IN004	Industrial Switches & Sockets	1	188
IN005	Industrial Switches & Sockets	1	188
IN006	Industrial Switches & Sockets	1	188
IN007	Industrial Switches & Sockets	1	188
IN008	Industrial Switches & Sockets	1	188
IN009	Industrial Switches & Sockets	1	188
IP3G	Weatherproof	1	170
IP5G	Weatherproof	1	170
IP663G	Weatherproof	1	170
IP665G	Weatherproof	1	170

I.			
Code	Catalogue Section	Qty	Page
IP68JBS	Lamps & Lighting Accessories	1	449
IPREMOTE	Weatherproof	1	170

J.			
Code	Catalogue Section	Qty	Page
JB0010	Weatherproof	1	173
JB0010BK	Weatherproof	1	173
JB0011	Weatherproof	1	174
JB002	Weatherproof	1	174
JB003	Weatherproof	1	174
JB004	Weatherproof	1	174
JB006	Weatherproof	1	174
JB007	Weatherproof	1	173
JB007BK	Weatherproof	1	173
JB008	Weatherproof	1	173
JB008BK	Weatherproof	1	173
JB009	Weatherproof	1	173
JB009BK	Weatherproof	1	173
JB55	Weatherproof	1	172
JB55BK	Weatherproof	1	172

K.			
Code	Catalogue Section	Qty	Page
KIT16B	Groundlights & Deck Lighting	1	354
KIT16W	Groundlights & Deck Lighting	1	354
KIT16WW	Groundlights & Deck Lighting	1	354

L.			
Code	Catalogue Section	Qty	Page
L01C	Downlights	1	219
L01CBR	Downlights	1	219
L01W	Downlights	1	219
L02B1	Downlights	1	218
L02BK1	Downlights	1	218
L02C1	Downlights	1	218
L02CBR1	Downlights	1	218
L02W1	Downlights	1	218
LANT1	Outdoor Wall Lights & Bollards	1	328
LANT1BKP	Outdoor Wall Lights & Bollards	1	328
LANT1W	Outdoor Wall Lights & Bollards	1	328
LANT1WP	Outdoor Wall Lights & Bollards	1	328
LANT2	Outdoor Wall Lights & Bollards	1	328
LANT2W	Outdoor Wall Lights & Bollards	1	328
LANT3	Outdoor Wall Lights & Bollards	1	329
LANT3BKP	Outdoor Wall Lights & Bollards	1	329
LANT3W	Outdoor Wall Lights & Bollards	1	329
LANT3WP	Outdoor Wall Lights & Bollards	1	329
LANT4	Outdoor Wall Lights & Bollards	1	329
LANT4W	Outdoor Wall Lights & Bollards	1	329
LANTBK	Outdoor Wall Lights & Bollards	1	330
LANTSS	Outdoor Wall Lights & Bollards	1	330
LDGL5	Groundlights & Deck Lighting	1	353
LDGL6	Groundlights & Deck Lighting	1	353
LDGL9	Groundlights & Deck Lighting	1	353
LE04C1	Downlights	1	219
LE04W1	Downlights	1	219
LED100	Under Cabinet	1	291
LED1000	Under Cabinet	1	291
LED11WB	Under Cabinet	1	290

L.			
Code	Catalogue Section	Qty	Page
LED11WCW	Under Cabinet	1	290
LED11WWW	Under Cabinet	1	290
LED250	Under Cabinet	1	291
LED2500	Under Cabinet	1	291
LED3WB	Under Cabinet	1	290
LED3WCW	Under Cabinet	1	290
LED3WWW	Under Cabinet	1	290
LED5WB	Under Cabinet	1	290
LED5WCW	Under Cabinet	1	290
LED5WWW	Under Cabinet	1	290
LED8SPLIT	Under Cabinet	1	291
LEDAD36	Under Cabinet	1	291
LEDAD36W	Under Cabinet	1	291
LEDAMP	LED Flex	1	304
LEDBAT17	Battens	1	409
LEDBAT22	Battens	1	409
LEDBAT26	Battens	1	409
LEDBAT9	Battens	1	409
LEDDIMMER	Under Cabinet	1	291
LEDFCLIP	Under Cabinet	1	290
LEDFCON	Under Cabinet	1	290
LEDFR1	LED Flex	1	302
LEDFR2	LED Flex	1	302
LEDFR4	LED Flex	1	302
LEDFR5	LED Flex	1	302
LEDFR6	LED Flex	1	302
LEDFR7	LED Flex	1	302
LEDFR8	LED Flex	1	302
LEDGL3D	Groundlights & Deck Lighting	1	350
LEDGL3W	Groundlights & Deck Lighting	1	350
LEDM06B	Bathroom	1	282
LEDM06W	Bathroom	1	282
LEDM07B	Groundlights & Deck Lighting	1	352
LEDM07W	Groundlights & Deck Lighting	1	352
LEDM08B1	Groundlights & Deck Lighting	1	352
LEDM08W1	Groundlights & Deck Lighting	1	352
LEDRACON	Under Cabinet	1	290
LEDT11WCW	Under Cabinet	1	291
LEDT11WWW	Under Cabinet	1	291
LEDT3WCW	Under Cabinet	1	291
LEDT3WWW	Under Cabinet	1	291
LEDT5WCW	Under Cabinet	1	291
LEDT5WWW	Under Cabinet	1	291
LEDTCLIP	Under Cabinet	1	291
LEDTCON	Under Cabinet	1	291
LEDTD1	Under Cabinet	1	290
LEDTD2	Under Cabinet	1	290
LFX512CW	LED Flex	1	300
LFX512DL	LED Flex	1	300
LFX512WW	LED Flex	1	300
LG06C	Downlights	1	218
LG06CBR	Downlights	1	218
LG06W	Downlights	1	218
LH01	Lamps & Lighting Accessories	50	452
LH01C	Lamps & Lighting Accessories	50	452
LH02	Lamps & Lighting Accessories	50	452

L.

Code	Catalogue Section	Qty	Page
LH03	Lamps & Lighting Accessories	50	452
LH04	Lamps & Lighting Accessories	50	452
LPAN30	Recessed, Surface & Suspension	1	395
LPAND	Recessed, Surface & Suspension	1	395
LPANKIT	Recessed, Surface & Suspension	1	395
LPANRC	Recessed, Surface & Suspension	1	395
LPANS	Recessed, Surface & Suspension	1	395
LSC1	Lamps & Lighting Accessories	10	452
LSPIKEA	Spike Lights	1	343
LVC1	Lamps & Lighting Accessories	100	452
LVC2	Lamps & Lighting Accessories	100	452
LWALL1A	Outdoor Wall Lights & Bollards	1	317
LWALL2A	Outdoor Wall Lights & Bollards	1	317
LWALL3A	Outdoor Wall Lights & Bollards	1	317
LWB165	Non-corrosive	1	415
LWB90	Non-corrosive	1	415
LWBEMKIT	High Bay / Low Bay	1	421
LWBMIC	High Bay / Low Bay	1	421
LWBMOU	High Bay / Low Bay	1	421
LWBPIR	High Bay / Low Bay	1	421
LWR2G	Outdoor Wall Lights & Bollards	1	320
LWR2W	Outdoor Wall Lights & Bollards	1	320
LWR4G	Outdoor Wall Lights & Bollards	1	320
LWR4W	Outdoor Wall Lights & Bollards	1	320
LWS2G	Outdoor Wall Lights & Bollards	1	320
LWS2W	Outdoor Wall Lights & Bollards	1	320
LWS4G	Outdoor Wall Lights & Bollards	1	320
LWS4W	Outdoor Wall Lights & Bollards	1	320

M.

Code	Catalogue Section	Qty	Page
M1100	Metal Clad	1	146
M1200	Metal Clad	1	146
M1G	Metal Clad	1	147
M2000	Metal Clad	1	146
M2G	Metal Clad	1	147
M3000	Metal Clad	1	146
M4000	Metal Clad	1	146
M4G	Metal Clad	1	147
M6000	Metal Clad	1	146
M6000N	Metal Clad	1	146
M6300	Metal Clad	1	146
M6300F	Metal Clad	1	146
M6300N	Metal Clad	1	146
M6RCD	Metal Clad	1	146
M7300	Metal Clad	1	147
M7400	Metal Clad	1	147
M8331N	Metal Clad	1	147
M8332N	Metal Clad	1	147
M8341	Metal Clad	1	146
M8341N	Metal Clad	1	146
M8500	Metal Clad	1	147
M8600	Metal Clad	1	147
M8700	Metal Clad	1	149
M8900	Metal Clad	1	149
M9RCD	Metal Clad	1	146
ML500	Bathroom	1	279

M.

Code	Catalogue Section	Qty	Page
MLC6045SD	Bathroom	1	279
MLR6045SD	Bathroom	1	278
MLRCTM2	Bathroom	1	277
MR7000	Metal Clad	1	146
MR7000U	Metal Clad	1	146
MR8333N	Metal Clad	1	147
MR9000	Metal Clad	1	146
MR9000U	Metal Clad	1	146
MR9124	Metal Clad	1	146
MR9224	Metal Clad	1	146
MRA436EMHF	Recessed, Surface & Suspension	1	398
MRA436HF	Recessed, Surface & Suspension	1	398
MRB418EMHF	Recessed, Surface & Suspension	1	398
MRB418HF	Recessed, Surface & Suspension	1	398
MRBLED	Recessed, Surface & Suspension	1	394
MRBLED6	Recessed, Surface & Suspension	1	394
MRJ45	Metal Clad	1	147
MSENSOR	Sensors	1	197

N.

Code	Catalogue Section	Qty	Page
NC65128HF	Non-corrosive	1	418
NC65135EMHF	Non-corrosive	1	418
NC65135HF	Non-corrosive	1	418
NC65228HF	Non-corrosive	1	418
NC65235EMHF	Non-corrosive	1	418
NC65235HF	Non-corrosive	1	418
NCT5CLIP	Non-corrosive	20	418
NET13BK	Datacomms	1	159
NET13GY	Datacomms	1	159
NET13WH	Datacomms	1	159
NET1GWH	Moulded Square Edge	1	13
NET2GWH	Moulded Square Edge	1	13
NET4GWH	Moulded Square Edge	1	13
NET5ABK	Datacomms	1	159
NET5AGY	Datacomms	1	159
NET5AWH	Datacomms	1	159
NETBR1G	Datacomms	1	157
NETBR1GGY	Datacomms	1	157
NETBR1GW	Datacomms	1	157
NETBR2G	Datacomms	1	157
NETBR2GGY	Datacomms	1	157
NETBR2GW	Datacomms	1	157
NETBR4G	Datacomms	1	157
NETBR4GGY	Datacomms	1	157
NETBR4GW	Datacomms	1	157
NETBTMBK	Datacomms	1	155
NETBTMGY	Datacomms	1	155
NETBTMWH	Datacomms	1	155
NETBTSBK	Datacomms	1	155
NETBTSGY	Datacomms	1	155
NETBTSWH	Datacomms	1	155
NETC510M	Datacomms	1	161
NETC51M	Datacomms	1	161
NETC524	Datacomms	1	161
NETC53M	Datacomms	1	161
NETC55M	Datacomms	1	161

N.				N.			
Code	Catalogue Section	Qty	Page	Code	Catalogue Section	Qty	Page
NETC5CP	Datacomms	1	161	NETTVSBK	Datacomms	1	156
NETC610M	Datacomms	1	161	NETTV5GY	Datacomms	1	156
NETC61M	Datacomms	1	161	NETTVSWH	Datacomms	1	156
NETC624	Datacomms	1	161	NETTVWH	Datacomms	1	155
NETC63M	Datacomms	1	161	NETUSBCBK	Datacomms	1	158
NETC65M	Datacomms	1	161	NETUSBCGY	Datacomms	1	158
NETC6CP	Datacomms	1	161	NETUSBCWH	Datacomms	1	158
NETCAT5BK	Datacomms	1	155	NH016W	Outdoor Wall Lights & Bollards	1	318
NETCAT5GY	Datacomms	1	155	NH017W	Outdoor Wall Lights & Bollards	1	318
NETCAT5WH	Datacomms	1	155	NH0183BD	Ceiling & Wall Lights	1	262
NETCAT6BK	Datacomms	1	155	NH01845Q	Ceiling & Wall Lights	1	262
NETCAT6GY	Datacomms	1	155	NH019W	Outdoor Wall Lights & Bollards	1	319
NETCAT6WH	Datacomms	1	155	NH020B	Outdoor Wall Lights & Bollards	1	319
NETDISATBK	Datacomms	1	156	NH020W	Outdoor Wall Lights & Bollards	1	319
NETDISATGY	Datacomms	1	156	NH021W	Outdoor Wall Lights & Bollards	1	318
NETDISATWH	Datacomms	1	156	NH022W	Outdoor Wall Lights & Bollards	1	318
NETDITVBK	Datacomms	1	156	NH023B	Ceiling & Wall Lights	1	263
NETDITVGY	Datacomms	1	156	NH023W	Ceiling & Wall Lights	1	263
NETDITVWH	Datacomms	1	156	NH025W	Ceiling & Wall Lights	1	263
NETHBK	Datacomms	1	159	NH027	Outdoor Wall Lights & Bollards	1	327
NETHDMIBK	Datacomms	1	157	NH027S	Outdoor Wall Lights & Bollards	1	327
NETHDMIGY	Datacomms	1	157	NH028	Outdoor Wall Lights & Bollards	1	327
NETHDMIWH	Datacomms	1	157	NH028S	Outdoor Wall Lights & Bollards	1	327
NETHGY	Datacomms	1	159	NSP1C	Ceiling & Wall Lights	1	259
NETHWH	Datacomms	1	159	NSP3C	Ceiling & Wall Lights	1	259
NETJBC5E	Datacomms	1	161	NSP4C	Ceiling & Wall Lights	1	259
NETJBC6	Datacomms	1	161	NSPGU1BC	Ceiling & Wall Lights	1	256
NETPIRBK	Datacomms	1	160	NSPGU1C	Ceiling & Wall Lights	1	256
NETPIRGY	Datacomms	1	160	NSPGU1W	Ceiling & Wall Lights	1	256
NETPIRSBK	Datacomms	1	160	NSPGU2BC	Ceiling & Wall Lights	1	256
NETPIRSGY	Datacomms	1	160	NSPGU2C	Ceiling & Wall Lights	1	256
NETPIRSWH	Datacomms	1	160	NSPGU3BC	Ceiling & Wall Lights	1	257
NETPIRWH	Datacomms	1	160	NSPGU3C	Ceiling & Wall Lights	1	257
NETQBK	Datacomms	1	159	NSPGU4BC	Ceiling & Wall Lights	1	257
NETQDBK	Datacomms	1	156	NSPGU4C	Ceiling & Wall Lights	1	257
NETQDGY	Datacomms	1	156	O.			
NETQDWH	Datacomms	1	156	Code	Catalogue Section	Qty	Page
NETQGY	Datacomms	1	159	OL01B	Outdoor Wall Lights & Bollards	1	334
NETQWH	Datacomms	1	159	OL01P	Outdoor Wall Lights & Bollards	1	334
NETRJ11BK	Datacomms	1	155	OL01W	Outdoor Wall Lights & Bollards	1	334
NETRJ11GY	Datacomms	1	155	OL61P	Outdoor Wall Lights & Bollards	1	333
NETRJ11WH	Datacomms	1	155	OL61W	Outdoor Wall Lights & Bollards	1	333
NETSATBK	Datacomms	1	155	OP2	Weatherproof	1	169
NETSATGY	Datacomms	1	155	OP21	Weatherproof	1	169
NETSATSBK	Datacomms	1	156	OP3	Weatherproof	1	169
NETSATSGY	Datacomms	1	156	OP3GBK	Weatherproof	1	170
NETSATSWH	Datacomms	1	156	OP5GBK	Weatherproof	1	170
NETSATWH	Datacomms	1	155	OP63N	Weatherproof	1	168
NETTRIBK	Datacomms	1	156	OP663GBK	Weatherproof	1	170
NETTRIGY	Datacomms	1	156	OP665GBK	Weatherproof	1	170
NETTRIWH	Datacomms	1	156	OP6N	Weatherproof	1	168
NETTS1BK	Datacomms	1	159	OP7N	Weatherproof	1	167
NETTS1GY	Datacomms	1	159	OP9KW	Weatherproof	1	167
NETTS1WH	Datacomms	1	159	OP9N	Weatherproof	1	167
NETTVBK	Datacomms	1	155	OP9R	Weatherproof	1	167
NETTVGY	Datacomms	1	155	OP9RCD	Weatherproof	1	168

O.

Code	Catalogue Section	Qty	Page
OPKEYFOB	Weatherproof	1	167
OPRCDKIT	Weatherproof	1	168
OPREMOTE	Weatherproof	1	170
OS001	Sensors	1	198
OS0011	Sensors	1	196
OS0014	Sensors	1	198
OS0014B	Sensors	1	198
OS0016	Sensors	1	196
OS0019	Sensors	1	196
OS001B	Sensors	1	198
OS004	Sensors	1	198
OS004B	Sensors	1	198
OS006	Weatherproof	1	169
OS006	Sensors	1	199
OS006B	Weatherproof	1	169
OS006B	Sensors	1	199
OS008	Sensors	1	197
OS009	Sensors	1	196
OS020	Sensors	1	199
OSEKW	Smart Home	1	206
OSMKW	Smart Home	1	206
OSPCKIT	Sensors	1	199
OSPIRKW	Sensors	1	196
OSPIRKW	Smart Home	1	206
OWALL1A	Outdoor Wall Lights & Bollards	1	314
OWALL1BC	Outdoor Wall Lights & Bollards	1	314
OWALL1BK	Outdoor Wall Lights & Bollards	1	314
OWALL1W	Outdoor Wall Lights & Bollards	1	314
OWALL2A	Outdoor Wall Lights & Bollards	1	314
OWALL2AP	Outdoor Wall Lights & Bollards	1	314
OWALL2BC	Outdoor Wall Lights & Bollards	1	314
OWALL2BCP	Outdoor Wall Lights & Bollards	1	314
OWALL2BK	Outdoor Wall Lights & Bollards	1	314
OWALL2BKP	Outdoor Wall Lights & Bollards	1	314
OWALL2W	Outdoor Wall Lights & Bollards	1	314
OWALL2WP	Outdoor Wall Lights & Bollards	1	314

P.

Code	Catalogue Section	Qty	Page
PIR0901	Sensors	1	197
PIR0901S	Sensors	1	197
PRCLED	Recessed, Surface & Suspension	1	396
PRCLED4	Recessed, Surface & Suspension	1	396
PRCLEDDEM	Recessed, Surface & Suspension	1	396
PRCLEDDEM4	Recessed, Surface & Suspension	1	396
PWL1	Ceiling & Wall Lights	1	260
PWL2	Ceiling & Wall Lights	1	260
PWL3	Ceiling & Wall Lights	1	260
PWL4	Ceiling & Wall Lights	1	260
PWRCC	Ceiling & Wall Lights	1	261
PWRRCR	Ceiling & Wall Lights	1	261

R.

Code	Catalogue Section	Qty	Page
RCDO01	Wiring Basics	1	183
RCDO02	Wiring Basics	1	183
RCTRGB	Bathroom	1	277
RD10BK	Outdoor Wall Lights & Bollards	1	323

R.

Code	Catalogue Section	Qty	Page
RD1B	Downlights	1	220
RD1C	Downlights	1	220
RD1CBR	Downlights	1	220
RD1W	Downlights	1	220
RD2B	Downlights	1	220
RD2C	Downlights	1	220
RD2CBR	Downlights	1	220
RD2W	Downlights	1	220
RDL9CCT	Commercial Downlights	1	385
RDSHC	Downlights	1	221
RDSHCBR	Downlights	1	221
RDSHW	Downlights	1	221
RGBAMP	LED Flex	1	304
RW6BC	Downlights	1	239
RW6C	Downlights	1	239
RW6CCT	Downlights	1	239
RW6CW	Downlights	1	239
RW6DTW	Downlights	1	239
RW6FBC	Downlights	1	239
RW6FBR	Downlights	1	239
RW6FC	Downlights	1	239
RW6FMB	Downlights	1	239
RW6FMW	Downlights	1	239
RW6MB	Downlights	1	239
RW6MW	Downlights	1	239
RW6WW	Downlights	1	239
RWL2A	Outdoor Wall Lights & Bollards	1	321
RWL2W	Outdoor Wall Lights & Bollards	1	321
RWL5A	Outdoor Wall Lights & Bollards	1	321
RWL5W	Outdoor Wall Lights & Bollards	1	321

S.

Code	Catalogue Section	Qty	Page
SC15PA	Wiring Basics	10	184
SC30PA	Wiring Basics	10	184
SC3PA	Wiring Basics	10	184
SC5PA	Wiring Basics	10	184
SC60PA	Wiring Basics	10	184
SF0100AT	Screwless	1	116
SF0100BC	Screwless	1	116
SF0100BN	Screwless	1	116
SF0100MB	Screwless	1	116
SF0100MW	Screwless	1	116
SF0100PB	Screwless	1	116
SF0100PC	Screwless	1	116
SF0100SB	Screwless	1	116
SF0140AT	Screwless	1	117
SF0140BC	Screwless	1	117
SF0140BN	Screwless	1	117
SF0140MB	Screwless	1	117
SF0140MW	Screwless	1	117
SF0140PB	Screwless	1	117
SF0140PC	Screwless	1	117
SF0140SB	Screwless	1	117
SF0150AT	Screwless	1	116
SF0150BC	Screwless	1	116
SF0150BN	Screwless	1	116

S.				S.			
Code	Catalogue Section	Qty	Page	Code	Catalogue Section	Qty	Page
SF0150MB	Screwless	1	116	SF2181SB	Screwless	1	108
SF0150MW	Screwless	1	116	SF2182AT	Screwless	1	108
SF0150PB	Screwless	1	116	SF2182BC	Screwless	1	108
SF0150PC	Screwless	1	116	SF2182BN	Screwless	1	108
SF0150SB	Screwless	1	116	SF2182MB	Screwless	1	108
SF1100AT	Screwless	1	102	SF2182MBB	Screwless	1	108
SF1100BC	Screwless	1	102	SF2182MW	Screwless	1	108
SF1100BN	Screwless	1	102	SF2182PB	Screwless	1	108
SF1100MB	Screwless	1	102	SF2182PC	Screwless	1	108
SF1100MBB	Screwless	1	102	SF2182SB	Screwless	1	108
SF1100MW	Screwless	1	102	SF2183AT	Screwless	1	109
SF1100PB	Screwless	1	102	SF2183BC	Screwless	1	109
SF1100PC	Screwless	1	102	SF2183BN	Screwless	1	109
SF1100SB	Screwless	1	102	SF2183MB	Screwless	1	109
SF1200AT	Screwless	1	103	SF2183MBB	Screwless	1	109
SF1200BC	Screwless	1	103	SF2183MW	Screwless	1	109
SF1200BN	Screwless	1	103	SF2183PB	Screwless	1	109
SF1200MB	Screwless	1	103	SF2183PC	Screwless	1	109
SF1200MBB	Screwless	1	103	SF2183SB	Screwless	1	109
SF1200MW	Screwless	1	103	SF2184AT	Screwless	1	109
SF1200PB	Screwless	1	103	SF2184BC	Screwless	1	109
SF1200PC	Screwless	1	103	SF2184BN	Screwless	1	109
SF1200SB	Screwless	1	103	SF2184MB	Screwless	1	109
SF12TOGBC	Screwless	1	106	SF2184MBB	Screwless	1	109
SF12TOGBN	Screwless	1	106	SF2184MW	Screwless	1	109
SF12TOGPB	Screwless	1	106	SF2184PB	Screwless	1	109
SF12TOGPC	Screwless	1	106	SF2184PC	Screwless	1	109
SF1GAT	Screwless	1	120	SF2184SB	Screwless	1	109
SF1GBC	Screwless	1	120	SF2GAT	Screwless	1	120
SF1GBN	Screwless	1	120	SF2GBC	Screwless	1	120
SF1GMB	Screwless	1	120	SF2GBN	Screwless	1	120
SF1GMW	Screwless	1	120	SF2GMB	Screwless	1	120
SF1GPB	Screwless	1	120	SF2GMW	Screwless	1	120
SF1GPC	Screwless	1	120	SF2GPB	Screwless	1	120
SF1GSB	Screwless	1	120	SF2GPC	Screwless	1	120
SF1TOGBC	Screwless	1	106	SF2GSB	Screwless	1	120
SF1TOGBN	Screwless	1	106	SF2TOGBC	Screwless	1	106
SF1TOGPB	Screwless	1	106	SF2TOGBN	Screwless	1	106
SF1TOGPC	Screwless	1	106	SF2TOGPB	Screwless	1	106
SF2000AT	Screwless	1	103	SF2TOGPC	Screwless	1	106
SF2000BC	Screwless	1	103	SF3000AT	Screwless	1	104
SF2000BN	Screwless	1	103	SF3000BC	Screwless	1	104
SF2000MB	Screwless	1	103	SF3000BN	Screwless	1	104
SF2000MBB	Screwless	1	103	SF3000MB	Screwless	1	104
SF2000MW	Screwless	1	103	SF3000MBB	Screwless	1	104
SF2000PB	Screwless	1	103	SF3000MW	Screwless	1	104
SF2000PC	Screwless	1	103	SF3000PB	Screwless	1	104
SF2000SB	Screwless	1	103	SF3000PC	Screwless	1	104
SF2181AT	Screwless	1	108	SF3000SB	Screwless	1	104
SF2181BC	Screwless	1	108	SF3TOGBC	Screwless	1	106
SF2181BN	Screwless	1	108	SF3TOGBN	Screwless	1	106
SF2181MB	Screwless	1	108	SF3TOGPB	Screwless	1	106
SF2181MBB	Screwless	1	108	SF3TOGPC	Screwless	1	106
SF2181MW	Screwless	1	108	SF4000AT	Screwless	1	104
SF2181PB	Screwless	1	108	SF4000BC	Screwless	1	104
SF2181PC	Screwless	1	108	SF4000BN	Screwless	1	104

S.

Code	Catalogue Section	Qty	Page
SF4000MB	Screwless	1	104
SF4000MBB	Screwless	1	104
SF4000MW	Screwless	1	104
SF4000PB	Screwless	1	104
SF4000PC	Screwless	1	104
SF4000SB	Screwless	1	104
SF4100AT	Screwless	1	105
SF4100BC	Screwless	1	105
SF4100BN	Screwless	1	105
SF4100MB	Screwless	1	105
SF4100MBB	Screwless	1	105
SF4100MW	Screwless	1	105
SF4100PB	Screwless	1	105
SF4100PC	Screwless	1	105
SF4100SB	Screwless	1	105
SF4200AT	Screwless	1	105
SF4200BC	Screwless	1	105
SF4200BN	Screwless	1	105
SF4200MB	Screwless	1	105
SF4200MBB	Screwless	1	105
SF4200MW	Screwless	1	105
SF4200PB	Screwless	1	105
SF4200PC	Screwless	1	105
SF4200SB	Screwless	1	105
SF4GAT	Screwless	1	121
SF4GBC	Screwless	1	121
SF4GBN	Screwless	1	121
SF4GMB	Screwless	1	121
SF4GMW	Screwless	1	121
SF4GPB	Screwless	1	121
SF4GPC	Screwless	1	121
SF4GSB	Screwless	1	121
SF4TOGBC	Screwless	1	106
SF4TOGBN	Screwless	1	106
SF4TOGPB	Screwless	1	106
SF4TOGPC	Screwless	1	106
SF5AAT	Screwless	1	102
SF5ABC	Screwless	1	102
SF5ABCG	Screwless	1	102
SF5ABCW	Screwless	1	102
SF5ABN	Screwless	1	102
SF5AMB	Screwless	1	102
SF5AMW	Screwless	1	102
SF5APB	Screwless	1	102
SF5APBW	Screwless	1	102
SF5APC	Screwless	1	102
SF5APCG	Screwless	1	102
SF5APCW	Screwless	1	102
SF5ASB	Screwless	1	102
SF6000AT	Screwless	1	111
SF6000BC	Screwless	1	111
SF6000BN	Screwless	1	111
SF6000MB	Screwless	1	111
SF6000MBB	Screwless	1	111
SF6000MW	Screwless	1	111
SF6000PB	Screwless	1	111

S.

Code	Catalogue Section	Qty	Page
SF6000PC	Screwless	1	111
SF6000SB	Screwless	1	111
SF6300AT	Screwless	1	111
SF6300BC	Screwless	1	111
SF6300BN	Screwless	1	111
SF6300FAT	Screwless	1	112
SF6300FBC	Screwless	1	112
SF6300FBN	Screwless	1	112
SF6300FMBB	Screwless	1	112
SF6300FMW	Screwless	1	112
SF6300FPC	Screwless	1	112
SF6300FSB	Screwless	1	112
SF6300MB	Screwless	1	111
SF6300MBB	Screwless	1	111
SF6300MW	Screwless	1	111
SF6300NAT	Screwless	1	112
SF6300NBC	Screwless	1	112
SF6300NBN	Screwless	1	112
SF6300NMB	Screwless	1	112
SF6300NMBB	Screwless	1	112
SF6300NMW	Screwless	1	112
SF6300NPB	Screwless	1	112
SF6300NPC	Screwless	1	112
SF6300NSB	Screwless	1	112
SF6300PB	Screwless	1	111
SF6300PC	Screwless	1	111
SF6300SB	Screwless	1	111
SF6GAT	Screwless	1	121
SF6GBC	Screwless	1	121
SF6GBN	Screwless	1	121
SF6GMB	Screwless	1	121
SF6GMW	Screwless	1	121
SF6GPB	Screwless	1	121
SF6GPC	Screwless	1	121
SF6GSB	Screwless	1	121
SF7300AT	Screwless	1	117
SF7300BC	Screwless	1	117
SF7300BN	Screwless	1	117
SF7300MB	Screwless	1	117
SF7300MW	Screwless	1	117
SF7300PB	Screwless	1	117
SF7300PC	Screwless	1	117
SF7300SB	Screwless	1	117
SF7400AT	Screwless	1	118
SF7400BC	Screwless	1	118
SF7400BN	Screwless	1	118
SF7400MB	Screwless	1	118
SF7400MW	Screwless	1	118
SF7400PB	Screwless	1	118
SF7400PC	Screwless	1	118
SF7400SB	Screwless	1	118
SF8331NAT	Screwless	1	114
SF8331NBC	Screwless	1	114
SF8331NBN	Screwless	1	114
SF8331NMB	Screwless	1	114
SF8331NMW	Screwless	1	114

S.				S.			
Code	Catalogue Section	Qty	Page	Code	Catalogue Section	Qty	Page
SF8331NPB	Screwless	1	114	SF8900PCW	Screwless	1	101
SF8331NPC	Screwless	1	114	SF8900SB	Screwless	1	101
SF8331NSB	Screwless	1	114	SFBLUEBC	Screwless	1	100
SF8332NAT	Screwless	1	114	SFBLUEMW	Screwless	1	100
SF8332NBC	Screwless	1	114	SFCARDBC	Screwless	1	110
SF8332NBN	Screwless	1	114	SFPLBC	Screwless	1	116
SF8332NMB	Screwless	1	114	SFPLMW	Screwless	1	116
SF8332NMW	Screwless	1	114	SFQUADAT	Screwless	1	100
SF8332NPB	Screwless	1	114	SFQUADBC	Screwless	1	100
SF8332NPC	Screwless	1	114	SFQUADBCG	Screwless	1	100
SF8332NSB	Screwless	1	114	SFQUADBCW	Screwless	1	100
SF8341AT	Screwless	1	113	SFQUADBN	Screwless	1	100
SF8341BC	Screwless	1	113	SFQUADMB	Screwless	1	100
SF8341BN	Screwless	1	113	SFQUADMW	Screwless	1	100
SF8341MB	Screwless	1	113	SFQUADPB	Screwless	1	100
SF8341MBB	Screwless	1	113	SFQUADPBW	Screwless	1	100
SF8341MW	Screwless	1	113	SFQUADPC	Screwless	1	100
SF8341NAT	Screwless	1	113	SFQUADPCG	Screwless	1	100
SF8341NBC	Screwless	1	113	SFQUADPCW	Screwless	1	100
SF8341NBN	Screwless	1	113	SFQUADSB	Screwless	1	100
SF8341NMB	Screwless	1	113	SFR192LAT	Screwless	1	128
SF8341MABB	Screwless	1	113	SFR192LBC	Screwless	1	128
SF8341NMW	Screwless	1	113	SFR192LBCG	Screwless	1	128
SF8341NPB	Screwless	1	113	SFR192LBCW	Screwless	1	128
SF8341NPC	Screwless	1	113	SFR192LMBB	Screwless	1	128
SF8341NSB	Screwless	1	113	SFR192LMW	Screwless	1	128
SF8341PB	Screwless	1	113	SFR192LSB	Screwless	1	128
SF8341PC	Screwless	1	113	SFR192RAT	Screwless	1	126
SF8341SB	Screwless	1	113	SFR192RBC	Screwless	1	126
SF8350AT	Screwless	1	119	SFR192RBCG	Screwless	1	126
SF8350BC	Screwless	1	119	SFR192RBCW	Screwless	1	126
SF8350BN	Screwless	1	119	SFR192RMBB	Screwless	1	126
SF8350MB	Screwless	1	119	SFR192RMW	Screwless	1	126
SF8350MW	Screwless	1	119	SFR192RSB	Screwless	1	126
SF8350PB	Screwless	1	119	SFR194AT	Screwless	1	124
SF8350PC	Screwless	1	119	SFR194BC	Screwless	1	124
SF8350SB	Screwless	1	119	SFR194BCG	Screwless	1	124
SF8360AT	Screwless	1	119	SFR194BCW	Screwless	1	124
SF8360BC	Screwless	1	119	SFR194MBB	Screwless	1	124
SF8360BN	Screwless	1	119	SFR194MW	Screwless	1	124
SF8360MB	Screwless	1	119	SFR194SB	Screwless	1	124
SF8360MW	Screwless	1	119	SFR298AT	Screwless	1	122
SF8360PB	Screwless	1	119	SFR298BC	Screwless	1	122
SF8360PC	Screwless	1	119	SFR298BCG	Screwless	1	122
SF8360SB	Screwless	1	119	SFR298BCW	Screwless	1	122
SF8900AT	Screwless	1	101	SFR298MBB	Screwless	1	122
SF8900BC	Screwless	1	101	SFR298MW	Screwless	1	122
SF8900BCG	Screwless	1	101	SFR298SB	Screwless	1	122
SF8900BCW	Screwless	1	101	SFR7000AT	Screwless	1	98
SF8900BN	Screwless	1	101	SFR7000BC	Screwless	1	98
SF8900MB	Screwless	1	101	SFR7000BCG	Screwless	1	98
SF8900MW	Screwless	1	101	SFR7000BCW	Screwless	1	98
SF8900PB	Screwless	1	101	SFR7000BN	Screwless	1	98
SF8900PBW	Screwless	1	101	SFR7000MB	Screwless	1	98
SF8900PC	Screwless	1	101	SFR7000MBB	Screwless	1	98
SF8900PCG	Screwless	1	101	SFR7000MW	Screwless	1	98

S.

Code	Catalogue Section	Qty	Page
SFR7000PB	Screwless	1	98
SFR7000PBW	Screwless	1	98
SFR7000PC	Screwless	1	98
SFR7000PCG	Screwless	1	98
SFR7000PCW	Screwless	1	98
SFR7000SB	Screwless	1	98
SFR7USB4AT	Screwless	1	97
SFR7USB4BC	Screwless	1	97
SFR7USB4BCG	Screwless	1	97
SFR7USB4BCW	Screwless	1	97
SFR7USB4BN	Screwless	1	97
SFR7USB4MB	Screwless	1	97
SFR7USB4MBB	Screwless	1	97
SFR7USB4MW	Screwless	1	97
SFR7USB4PB	Screwless	1	97
SFR7USB4PBW	Screwless	1	97
SFR7USB4PC	Screwless	1	97
SFR7USB4PCG	Screwless	1	97
SFR7USB4PCW	Screwless	1	97
SFR7USB4SB	Screwless	1	97
SFR8333NAT	Screwless	1	115
SFR8333NBC	Screwless	1	115
SFR8333NBCG	Screwless	1	115
SFR8333NBCW	Screwless	1	115
SFR8333NBN	Screwless	1	115
SFR8333NMB	Screwless	1	115
SFR8333NMBB	Screwless	1	115
SFR8333NMW	Screwless	1	115
SFR8333NPB	Screwless	1	115
SFR8333NPBW	Screwless	1	115
SFR8333NPC	Screwless	1	115
SFR8333NPCG	Screwless	1	115
SFR8333NPCW	Screwless	1	115
SFR8333NSB	Screwless	1	115
SFR8333UAT	Screwless	1	96
SFR8333UBC	Screwless	1	96
SFR8333UBCG	Screwless	1	96
SFR8333UBCW	Screwless	1	96
SFR8333UMBB	Screwless	1	96
SFR8333UMW	Screwless	1	96
SFR8333USB	Screwless	1	96
SFR9000AT	Screwless	1	92
SFR9000BC	Screwless	1	92
SFR9000BCG	Screwless	1	92
SFR9000BCW	Screwless	1	92
SFR9000BN	Screwless	1	92
SFR9000MB	Screwless	1	92
SFR9000MBB	Screwless	1	92
SFR9000MW	Screwless	1	92
SFR9000PB	Screwless	1	92
SFR9000PBW	Screwless	1	92
SFR9000PC	Screwless	1	92
SFR9000PCG	Screwless	1	92
SFR9000PCW	Screwless	1	92
SFR9000SB	Screwless	1	92

S.

Code	Catalogue Section	Qty	Page
SFR9124AT	Screwless	1	99
SFR9124BC	Screwless	1	99
SFR9124BCG	Screwless	1	99
SFR9124BCW	Screwless	1	99
SFR9124BN	Screwless	1	99
SFR9124MB	Screwless	1	99
SFR9124MBB	Screwless	1	99
SFR9124MW	Screwless	1	99
SFR9124PB	Screwless	1	99
SFR9124PBW	Screwless	1	99
SFR9124PC	Screwless	1	99
SFR9124PCG	Screwless	1	99
SFR9124PCW	Screwless	1	99
SFR9124SB	Screwless	1	99
SFR9224AT	Screwless	1	93
SFR9224BC	Screwless	1	93
SFR9224BCG	Screwless	1	93
SFR9224BCW	Screwless	1	93
SFR9224BN	Screwless	1	93
SFR9224MB	Screwless	1	93
SFR9224MBB	Screwless	1	93
SFR9224MW	Screwless	1	93
SFR9224PB	Screwless	1	93
SFR9224PBW	Screwless	1	93
SFR9224PC	Screwless	1	93
SFR9224PCG	Screwless	1	93
SFR9224PCW	Screwless	1	93
SFR9224SB	Screwless	1	93
SFR9904NBC	Screwless	1	96
SFR9904NBCG	Screwless	1	96
SFR9904NBCW	Screwless	1	96
SFR9904NMBB	Screwless	1	96
SFR9904NMW	Screwless	1	96
SFR9905BC	Screwless	1	94
SFR9905BCG	Screwless	1	94
SFR9905BCW	Screwless	1	94
SFR9905MBB	Screwless	1	94
SFR9905MW	Screwless	1	94
SFR9909AT	Screwless	1	94
SFR9909BC	Screwless	1	94
SFR9909BCG	Screwless	1	94
SFR9909MBB	Screwless	1	94
SFR9909MW	Screwless	1	94
SFR9909SB	Screwless	1	94
SFR9919AT	Screwless	1	99
SFR9919BC	Screwless	1	99
SFR9919MBB	Screwless	1	99
SFR9919MW	Screwless	1	99
SFR9919SB	Screwless	1	99
SFR992LAT	Screwless	1	129
SFR992LBC	Screwless	1	129
SFR992LBCG	Screwless	1	129
SFR992LBCW	Screwless	1	129
SFR992LMBB	Screwless	1	129

S.				S.			
Code	Catalogue Section	Qty	Page	Code	Catalogue Section	Qty	Page
SFR992LMW	Screwless	1	129	SHE2G	Bulkheads & Wall Packs	1	379
SFR992LSB	Screwless	1	129	SHE2GEM	Bulkheads & Wall Packs	1	379
SFR992RAT	Screwless	1	127	SHE2GEMP	Bulkheads & Wall Packs	1	379
SFR992RBC	Screwless	1	127	SHE2GEMS	Bulkheads & Wall Packs	1	379
SFR992RBCG	Screwless	1	127	SHE2GP	Bulkheads & Wall Packs	1	379
SFR992RBCW	Screwless	1	127	SHE2GS	Bulkheads & Wall Packs	1	379
SFR992RMBB	Screwless	1	127	SK0010	Specialist Sockets	1	140
SFR992RMW	Screwless	1	127	SK0011	Specialist Sockets	1	139
SFR992RSB	Screwless	1	127	SK0012	Specialist Sockets	1	141
SFR994AT	Screwless	1	125	SK0015	Specialist Sockets	1	140
SFR994BC	Screwless	1	125	SK004	Specialist Sockets	1	139
SFR994BCG	Screwless	1	125	SK005A	Specialist Sockets	1	138
SFR994BCW	Screwless	1	125	SK006	Specialist Sockets	1	138
SFR994MBB	Screwless	1	125	SK9909BC	Specialist Sockets	1	138
SFR994MW	Screwless	1	125	SK9909BN	Specialist Sockets	1	138
SFR994SB	Screwless	1	125	SK9909PC	Specialist Sockets	1	138
SFR998AT	Screwless	1	123	SKR0013	Specialist Sockets	1	137
SFR998BC	Screwless	1	123	SKR0014	Specialist Sockets	1	136
SFR998BCG	Screwless	1	123	SKR001A	Specialist Sockets	1	137
SFR998BCW	Screwless	1	123	SKR002A	Specialist Sockets	1	136
SFR998MBB	Screwless	1	123	SKR003A	Specialist Sockets	1	141
SFR998MW	Screwless	1	123	SKR008	Specialist Sockets	1	136
SFR998SB	Screwless	1	123	SKR009A	Specialist Sockets	1	136
SFRJ45AT	Screwless	1	118	SKRECF	Specialist Sockets	1	139
SFRJ45BC	Screwless	1	118	SL20CCTB	Floodlights & Heating	1	365
SFRJ45BN	Screwless	1	118	SL20CCTW	Floodlights & Heating	1	365
SFRJ45MB	Screwless	1	118	SL30CCTB	Floodlights & Heating	1	365
SFRJ45MW	Screwless	1	118	SL30CCTW	Floodlights & Heating	1	365
SFRJ45PB	Screwless	1	118	SL6USBC	Bathroom	1	274
SFRJ45PC	Screwless	1	118	SL6USBMB	Bathroom	1	274
SFRJ45SB	Screwless	1	118	SL6USBW	Bathroom	1	274
SFTS1AT	Screwless	1	103	SLIGHT2	Bathroom	1	275
SFTS1BC	Screwless	1	103	SLULED	Bathroom	1	275
SFTS1BN	Screwless	1	103	SN0100	Moulded Square Edge	1	13
SFTS1MB	Screwless	1	103	SN0110	Moulded Square Edge	1	13
SFTS1MW	Screwless	1	103	SN0120	Moulded Square Edge	1	13
SFTS1PC	Screwless	1	103	SN0140	Moulded Square Edge	1	13
SFTS1SB	Screwless	1	103	SN1000	Moulded Square Edge	1	11
SHE1B	Bulkheads & Wall Packs	1	378	SN1100	Moulded Square Edge	1	10
SHE1BEM	Bulkheads & Wall Packs	1	378	SN1200	Moulded Square Edge	1	11
SHE1BEMP	Bulkheads & Wall Packs	1	378	SN127	Moulded Square Edge	1	11
SHE1BEMS	Bulkheads & Wall Packs	1	378	SN127P	Moulded Square Edge	10	13
SHE1BP	Bulkheads & Wall Packs	1	378	SN1300	Moulded Square Edge	10	13
SHE1BS	Bulkheads & Wall Packs	1	378	SN1381	Wiring Basics	20	184
SHE1G	Bulkheads & Wall Packs	1	378	SN1382	Wiring Basics	20	184
SHE1GEM	Bulkheads & Wall Packs	1	378	SN1383	Wiring Basics	20	184
SHE1GEMP	Bulkheads & Wall Packs	1	378	SN1383BK	Wiring Basics	20	184
SHE1GEMS	Bulkheads & Wall Packs	1	378	SN13AFUSE	Wiring Basics	10	184
SHE1GP	Bulkheads & Wall Packs	1	378	SN1400	Moulded Square Edge	10	13
SHE1GS	Bulkheads & Wall Packs	1	378	SN1500	Moulded Square Edge	5	13
SHE2B	Bulkheads & Wall Packs	1	379	SN1510	Moulded Square Edge	5	13
SHE2BEM	Bulkheads & Wall Packs	1	379	SN1600	Moulded Square Edge	5	13
SHE2BEMP	Bulkheads & Wall Packs	1	379	SN1610	Moulded Square Edge	10	13
SHE2BEMS	Bulkheads & Wall Packs	1	379	SN1700	Moulded Square Edge	10	13
SHE2BP	Bulkheads & Wall Packs	1	379	SN1800	Moulded Square Edge	5	13
SHE2BS	Bulkheads & Wall Packs	1	379	SN1DIM	Moulded Square Edge	1	11

S.

Code	Catalogue Section	Qty	Page
SN2000	Moulded Square Edge	1	11
SN2135B	Wiring Basics	20	184
SN2135W	Wiring Basics	20	184
SN2161	Moulded Square Edge	1	11
SN2162	Moulded Square Edge	1	11
SN2163	Moulded Square Edge	1	11
SN2164	Moulded Square Edge	1	11
SN2165	Moulded Square Edge	1	11
SN2DIM	Moulded Square Edge	1	11
SN3000	Moulded Square Edge	1	11
SN3AFUSE	Wiring Basics	10	184
SN4000	Moulded Square Edge	1	11
SN400M	Moulded Square Edge	1	11
SN4100	Moulded Square Edge	1	11
SN4200	Moulded Square Edge	1	11
SN5AFUSE	Wiring Basics	10	184
SN5U	Moulded Square Edge	1	11
SN6000	Moulded Square Edge	1	12
SN6000-3A	Moulded Square Edge	1	12
SN6000N	Moulded Square Edge	1	12
SN6300	Moulded Square Edge	1	12
SN6300N	Moulded Square Edge	1	12
SN7000	Moulded Square Edge	1	10
SN7000S	Moulded Square Edge	1	10
SN7000U	Moulded Square Edge	1	10
SN7300	Moulded Square Edge	1	13
SN7400	Moulded Square Edge	1	13
SN81BK	Wiring Basics	1	182
SN81WH	Wiring Basics	1	182
SN8200	Wiring Basics	10	182
SN8210	Wiring Basics	10	182
SN8220	Wiring Basics	10	182
SN8230	Wiring Basics	10	182
SN8250	Wiring Basics	20	182
SN8260	Wiring Basics	10	182
SN8270	Wiring Basics	10	183
SN8280	Wiring Basics	10	183
SN8290	Wiring Basics	5	182
SN8300	Wiring Basics	5	182
SN8331	Moulded Square Edge	1	12
SN8331N	Moulded Square Edge	1	12
SN8331NW	Moulded Square Edge	1	12
SN8331W	Moulded Square Edge	1	12
SN8332	Moulded Square Edge	1	12
SN8332N	Moulded Square Edge	1	12
SN8332NW	Moulded Square Edge	1	12
SN8332W	Moulded Square Edge	1	12
SN8333	Moulded Square Edge	1	12
SN8333N	Moulded Square Edge	1	12
SN8333NW	Moulded Square Edge	1	12
SN8333W	Moulded Square Edge	1	12
SN8335D	Wiring Basics	5	178
SN8340	Moulded Square Edge	1	12
SN8341	Moulded Square Edge	1	12
SN8341N	Moulded Square Edge	1	12
SN8342	Moulded Square Edge	1	12

S.

Code	Catalogue Section	Qty	Page
SN8350	Moulded Square Edge	1	13
SN8360	Moulded Square Edge	1	13
SN8370	Wiring Basics	10	178
SN8375	Wiring Basics	10	178
SN8380	Wiring Basics	10	178
SN8380D	Wiring Basics	10	178
SN8381	Wiring Basics	10	178
SN8382	Wiring Basics	10	178
SN8400	Wiring Basics	20	179
SN8400B	Wiring Basics	20	179
SN8410	Wiring Basics	20	179
SN8410B	Wiring Basics	20	179
SN8420	Wiring Basics	10	179
SN8420B	Wiring Basics	10	179
SN8430	Wiring Basics	10	179
SN8430B	Wiring Basics	10	179
SN8460	Wiring Basics	10	179
SN8460B	Wiring Basics	10	179
SN8470	Wiring Basics	5	179
SN8470B	Wiring Basics	5	179
SN8900N	Moulded Square Edge	1	10
SN9000	Moulded Square Edge	1	8
SN9000S	Moulded Square Edge	1	8
SN9000U	Moulded Square Edge	1	8
SN9001	Moulded Square Edge	1	8
SN9002	Moulded Square Edge	1	8
SN9903	Moulded Square Edge	1	10
SN9904	Moulded Square Edge	1	8
SN9909	Moulded Square Edge	1	9
SN9KW	Moulded Square Edge	1	8
SNEB1	Wiring Basics	10	179
SNEB2	Wiring Basics	10	179
SNMIXEDFUSE	Wiring Basics	10	184
SPEK2W4CCT	Downlights	1	237
SPEKB	Downlights	1	237
SPEKBC	Downlights	1	237
SPEKMB	Downlights	1	237
SPEKPC	Downlights	1	237
SPEKW	Downlights	1	237
SPIKE4BL	Spike Lights	1	342
SPIKE5A	Spike Lights	1	342
SPIKE5S	Spike Lights	1	343
SPIKEGUBK	Spike Lights	1	340
SPIKEW	Spike Lights	1	343
ST6ABK	Wiring Basics	10	182
ST6AWH	Wiring Basics	10	182
ST7USB4	Moulded Square Edge	1	9
SUR5LED	Recessed, Surface & Suspension	1	397
SUR5LEDEM	Recessed, Surface & Suspension	1	397
SURF236EMHF	Recessed, Surface & Suspension	1	399
SURF236HF	Recessed, Surface & Suspension	1	399
SURF258EMHF	Recessed, Surface & Suspension	1	399
SURF258HF	Recessed, Surface & Suspension	1	399
SURF270EMHF	Recessed, Surface & Suspension	1	399
SURF270HF	Recessed, Surface & Suspension	1	399
SURF418EMHF	Recessed, Surface & Suspension	1	399

S.			
Code	Catalogue Section	Qty	Page
SURF418HF	Recessed, Surface & Suspension	1	399
SWS01C	Downlights	1	221
SWS01W	Downlights	1	221

T.			
Code	Catalogue Section	Qty	Page
T02	Lamps & Lighting Accessories	1	449
T5114	Battens	4	411
T5128	Battens	4	411
T5128EM	Battens	1	411
T5135	Battens	4	411
T5135EM	Battens	1	411
T5149	Battens	4	411
T5149EM	Battens	1	411
T5214	Battens	4	411
T5228	Battens	4	411
T5228EM	Battens	1	411
T5235	Battens	4	411
T5235EM	Battens	1	411
T5249	Battens	4	411
T5249EM	Battens	1	411
T5DIF2	Battens	2	411
T5DIF4	Battens	2	411
T5DIF5	Battens	2	411
T8118HF	Battens	4	410
T8136EMHF	Battens	1	410
T8136HF	Battens	4	410
T8158EMHF	Battens	1	410
T8158HF	Battens	4	410
T8170EMHF	Battens	1	410
T8170HF	Battens	4	410
T8218HF	Battens	4	410
T8236EMHF	Battens	1	410
T8236HF	Battens	4	410
T8258EMHF	Battens	1	410
T8258HF	Battens	4	410
T8270EMHF	Battens	1	410
T8270HF	Battens	4	410
T88LED12	Battens	1	404
T88LED14	Battens	1	404
T88LED15	Battens	1	404
T88LED15EM1	Battens	1	404
T88LED16	Battens	1	404
T88LED16EM1	Battens	1	404
T88LED22	Battens	1	405
T88LED24	Battens	1	405
T88LED25	Battens	1	405
T88LED25EM1	Battens	1	405
T88LED26	Battens	1	405
T88LED26EM1	Battens	1	405
T8DIFF136	Battens	2	410
T8DIFF158	Battens	2	410
T8DIFF170	Battens	2	410
T8DIFF236	Battens	2	410
T8DIFF258	Battens	2	410
T8DIFF270	Battens	2	410
T8LB14	Battens	4	403

T.			
Code	Catalogue Section	Qty	Page
T8LB15	Battens	4	403
T8LB16	Battens	4	403
T8LB24	Battens	4	403
T8LB25	Battens	4	403
T8LB26	Battens	4	403
T8LED6	Battens	1	403
T8LED6D	Battens	1	403
T8LEDP18CW	Battens	4	403
T8LEDP18DL	Battens	4	403
T8LEDP24CW	Battens	4	403
T8LEDP24DL	Battens	4	403
T8LEDP9CW	Battens	4	403
T8LEDP9DL	Battens	4	403
T8REF36	Battens	4	410
T8REF58	Battens	4	410
T8REF70	Battens	4	410
TE1	Wiring Basics	1	186
TE2	Wiring Basics	1	186
TE3	Wiring Basics	1	186
TE4B	Wiring Basics	1	186
T0RE4K18	Non-corrosive	1	415
T0RE4K36	Non-corrosive	1	415
T0RE4K45	Non-corrosive	1	415
T0RE5K18	Non-corrosive	1	415
T0RE5K36	Non-corrosive	1	415
T0RE5K45	Non-corrosive	1	415
TPB14EMLED	Bulkheads & Wall Packs	1	375
TPB14EMSLED	Bulkheads & Wall Packs	1	375
TPB14LED	Bulkheads & Wall Packs	1	375
TPB14LEDA	Bulkheads & Wall Packs	1	375
TPB14SLED	Bulkheads & Wall Packs	1	375
TPB33BRRG	Bulkheads & Wall Packs	1	375
TPB33CHRGR	Bulkheads & Wall Packs	1	375
TPOV60B	Bulkheads & Wall Packs	1	381
TPOV60W	Bulkheads & Wall Packs	1	381
TPR14LED	Bulkheads & Wall Packs	1	375
TPR14LEDA	Bulkheads & Wall Packs	1	375
TPR14LEDEM	Bulkheads & Wall Packs	1	375
TPR14LEDS	Bulkheads & Wall Packs	1	375
TRIBCCW	Under Cabinet	1	293
TRIBCWW	Under Cabinet	1	293
TRK1MAW	Ceiling & Wall Lights	1	253
TRK1MBK	Ceiling & Wall Lights	1	253
TRK1MS	Ceiling & Wall Lights	1	253
TRK2MABK	Ceiling & Wall Lights	1	253
TRK2MAS	Ceiling & Wall Lights	1	253
TRK2MAW	Ceiling & Wall Lights	1	253
TRK3MABK	Ceiling & Wall Lights	1	253
TRK3MAS	Ceiling & Wall Lights	1	253
TRK3MAW	Ceiling & Wall Lights	1	253
TRK8270BC	Ceiling & Wall Lights	1	250
TRK8270BK	Ceiling & Wall Lights	1	250
TRK8270W	Ceiling & Wall Lights	1	250
TRK8271BC	Ceiling & Wall Lights	1	250
TRK8271BK	Ceiling & Wall Lights	1	250
TRK8271W	Ceiling & Wall Lights	1	250

T.

Code	Catalogue Section	Qty	Page
TRKAD1BK	Ceiling & Wall Lights	1	253
TRKAD1S	Ceiling & Wall Lights	1	253
TRKAD1W	Ceiling & Wall Lights	1	253
TRKC1BK	Ceiling & Wall Lights	1	253
TRKC1S	Ceiling & Wall Lights	1	253
TRKC1W	Ceiling & Wall Lights	1	253
TRKDE1BK	Ceiling & Wall Lights	1	253
TRKDE1S	Ceiling & Wall Lights	1	253
TRKDE1W	Ceiling & Wall Lights	1	253
TRKFC1BK	Ceiling & Wall Lights	1	253
TRKFC1S	Ceiling & Wall Lights	1	253
TRKFC1W	Ceiling & Wall Lights	1	253
TRKIT4BC	Ceiling & Wall Lights	1	251
TRKIT4BK	Ceiling & Wall Lights	1	251
TRKIT4W	Ceiling & Wall Lights	1	251
TRKIT8ABC	Ceiling & Wall Lights	1	251
TRKIT8ABK	Ceiling & Wall Lights	1	251
TRKIT8AW	Ceiling & Wall Lights	1	251
TRKLC1BK	Ceiling & Wall Lights	1	253
TRKLC1S	Ceiling & Wall Lights	1	253
TRKLC1W	Ceiling & Wall Lights	1	253
TRKPF1BK	Ceiling & Wall Lights	1	253
TRKPF1S	Ceiling & Wall Lights	1	253
TRKPF1W	Ceiling & Wall Lights	1	253
TRKRA1BK	Ceiling & Wall Lights	1	253
TRKRA1S	Ceiling & Wall Lights	1	253
TRKRA1W	Ceiling & Wall Lights	1	253
TRKSP1BC	Ceiling & Wall Lights	1	248
TRKSP1BK	Ceiling & Wall Lights	1	248
TRKSP1W	Ceiling & Wall Lights	1	248
TRKSP2BC	Ceiling & Wall Lights	1	248
TRKSP2BK	Ceiling & Wall Lights	1	248
TRKSP2W	Ceiling & Wall Lights	1	248
TRKSP3BC	Ceiling & Wall Lights	1	248
TRKSP3BK	Ceiling & Wall Lights	1	248
TRKSP3W	Ceiling & Wall Lights	1	248
TRKSP4BC	Ceiling & Wall Lights	1	249
TRKSP4BK	Ceiling & Wall Lights	1	249
TRKSP4W	Ceiling & Wall Lights	1	249
TRKSP5BC	Ceiling & Wall Lights	1	249
TRKSP5BK	Ceiling & Wall Lights	1	249
TRKSP5W	Ceiling & Wall Lights	1	249
TRKSP6BC	Ceiling & Wall Lights	1	249
TRKSP6BK	Ceiling & Wall Lights	1	249
TRKSP6W	Ceiling & Wall Lights	1	249
TRKSP8B	Ceiling & Wall Lights	1	249
TRKSP8BC	Ceiling & Wall Lights	1	249
TRKSP8W	Ceiling & Wall Lights	1	249
TRKT1BK	Ceiling & Wall Lights	1	253
TRKT1S	Ceiling & Wall Lights	1	253
TRKT1W	Ceiling & Wall Lights	1	253
TRKX1BK	Ceiling & Wall Lights	1	253
TRKX1S	Ceiling & Wall Lights	1	253
TRKX1W	Ceiling & Wall Lights	1	253
TRLED12	Non-corrosive	1	416
TRLED14	Non-corrosive	1	416

T.

Code	Catalogue Section	Qty	Page
TRLED14EM	Non-corrosive	1	416
TRLED15	Non-corrosive	1	416
TRLED151	Non-corrosive	1	416
TRLED151EM	Non-corrosive	1	416
TRLED15D	Non-corrosive	1	416
TRLED15EM	Non-corrosive	1	416
TRLED15EMD	Non-corrosive	1	416
TRLED16	Non-corrosive	1	416
TRLED16D	Non-corrosive	1	416
TRLED16EM	Non-corrosive	1	416
TRLED16EMD	Non-corrosive	1	416
TRLED22	Non-corrosive	1	417
TRLED221	Non-corrosive	1	417
TRLED221EM	Non-corrosive	1	417
TRLED24	Non-corrosive	1	417
TRLED24EM	Non-corrosive	1	417
TRLED25	Non-corrosive	1	417
TRLED25AW	Non-corrosive	1	417
TRLED25EM	Non-corrosive	1	417
TRLED25EMD	Non-corrosive	1	417
TRLED26	Non-corrosive	1	417
TRLED26EM	Non-corrosive	1	417
TRLED26EMD	Non-corrosive	1	417
TRPCKIT	Sensors	1	199
TRRPC	Sensors	1	199

U.

Code	Catalogue Section	Qty	Page
UC1000	Under Cabinet	1	287
UC250	Under Cabinet	1	287
UC500	Under Cabinet	1	287
UCCUP	Under Cabinet	1	287
UCLCT13	Under Cabinet	1	287
UCLCT18	Under Cabinet	1	287
UCLCT4	Under Cabinet	1	287
UCLCT9	Under Cabinet	1	287
UCLED13CW	Under Cabinet	2	288
UCLED13WW	Under Cabinet	2	288
UCLED18CW	Under Cabinet	2	288
UCLED18WW	Under Cabinet	2	288
UCLED22CW	Under Cabinet	2	288
UCLED22WW	Under Cabinet	2	288
UCLED4CW	Under Cabinet	1	288
UCLED4WW	Under Cabinet	1	288
UCLED7CW	Under Cabinet	1	288
UCLED7WW	Under Cabinet	1	288
UCLED9CW	Under Cabinet	1	288
UCLED9WW	Under Cabinet	1	288
UCP200	Under Cabinet	1	287
UNDK3BCCW	Under Cabinet	1	295
UNDK3BCWW	Under Cabinet	1	295
UNDK3WCW	Under Cabinet	1	295
UNDK3WWW	Under Cabinet	1	295
UNDKCON	Under Cabinet	1	295
UNDKIT3BCCW	Under Cabinet	1	294
UNDKIT3BCWW	Under Cabinet	1	294

U.				V.			
Code	Catalogue Section	Qty	Page	Code	Catalogue Section	Qty	Page
UNDKIT3WCW	Under Cabinet	1	294	VFRIC8TCW	Downlights	1	241
UNDKIT3WWW	Under Cabinet	1	294	VFRIC8TWW	Downlights	1	241
USLED12	Under Cabinet	1	289	VFRIC8WW	Downlights	1	240
USLED123K	Under Cabinet	1	289	VFRICBEZC	Downlights	1	240
USLED7	Under Cabinet	1	289	VFRICBEZCBR	Downlights	1	240
USLED73K	Under Cabinet	1	289	VFRICBEZCW	Downlights	1	240
V.				VFRICC	Downlights	1	240
Code	Catalogue Section	Qty	Page	VFRICTBEZC	Downlights	1	241
VFCFBC	Downlights	1	226	VFRICTBEZCBR	Downlights	1	241
VFCFC	Downlights	1	226	VFRICTBEZCW	Downlights	1	241
VFCFIPBC	Downlights	1	227	VFRICTC	Downlights	1	241
VFCFIPC	Downlights	1	227	VFRSBEZBK	Downlights	1	244
VFCFIPW	Downlights	1	227	VFRSBEZCBR	Downlights	1	244
VFCFTBC	Downlights	1	227	VFRSBEZCH	Downlights	1	244
VFCFTC	Downlights	1	227	VFRSBEZCW	Downlights	1	244
VFCFTW	Downlights	1	227	VFRSGICB	Downlights	1	228
VFCFW	Downlights	1	226	VFRSGICC	Downlights	1	228
VFR200M	Moulded Square Edge	1	11	VFRSGICCBR	Downlights	1	228
VFR7EM	Downlights	1	241	VFRSGICW	Downlights	1	228
VFR8BEZBL	Downlights	1	242	VFRSHGICB	Downlights	1	229
VFR8BEZBR	Downlights	1	242	VFRSHGICC	Downlights	1	229
VFR8BEZCBR	Downlights	1	242	VFRSHGICCBR	Downlights	1	229
VFR8BEZCH	Downlights	1	242	VFRSHGICW	Downlights	1	229
VFR8BEZMW	Downlights	1	242	VML1	Bathroom	1	276
VFR8CW	Downlights	1	242	W.			
VFR8TBEZBL	Downlights	1	243	Code	Catalogue Section	Qty	Page
VFR8TBEZBR	Downlights	1	243	WAD12A	Outdoor Wall Lights & Bollards	1	322
VFR8TBEZCBR	Downlights	1	243	WAD12BK	Outdoor Wall Lights & Bollards	1	322
VFR8TBEZCH	Downlights	1	243	WALL1	Outdoor Wall Lights & Bollards	1	312
VFR8TBEZMW	Downlights	1	243	WALL1L	Outdoor Wall Lights & Bollards	1	310
VFR8TCW	Downlights	1	243	WALL1LBK	Outdoor Wall Lights & Bollards	1	310
VFR8TWW	Downlights	1	243	WALL1LC	Outdoor Wall Lights & Bollards	1	310
VFR8WW	Downlights	1	242	WALL2	Outdoor Wall Lights & Bollards	1	312
VFRBEZAB	Downlights	1	244	WALL2L	Outdoor Wall Lights & Bollards	1	310
VFRBEZBK	Downlights	1	244	WALL2LBK	Outdoor Wall Lights & Bollards	1	310
VFRBEZBR	Downlights	1	244	WALL2LC	Outdoor Wall Lights & Bollards	1	310
VFRBEZCBR	Downlights	1	244	WALL3	Outdoor Wall Lights & Bollards	1	312
VFRBEZCH	Downlights	1	244	WALL3L	Outdoor Wall Lights & Bollards	1	311
VFRBEZGM	Downlights	1	244	WALL3LBK	Outdoor Wall Lights & Bollards	1	311
VFRBEZW	Downlights	1	244	WALL3LC	Outdoor Wall Lights & Bollards	1	311
VFRCBC	Downlights	1	245	WALL4LSS	Outdoor Wall Lights & Bollards	1	311
VFRCC	Downlights	1	245	WALL5LSS	Outdoor Wall Lights & Bollards	1	311
VFRCOBCW	Downlights	1	244	WD12BC	Smart Home	1	209
VFRCOBCW1	Downlights	1	245	WD12RGBW	Smart Home	1	209
VFRCOBCW2	Downlights	1	245	WGULED	Groundlights & Deck Lighting	1	348
VFRCOBCW3	Downlights	1	245	WGULEN	Groundlights & Deck Lighting	1	348
VFRCOBWW	Downlights	1	244	WHGULED	Groundlights & Deck Lighting	1	348
VFRCOBWW1	Downlights	1	245	WP15CTP	Bulkheads & Wall Packs	1	382
VFRCOBWW2	Downlights	1	245	WSGULED	Groundlights & Deck Lighting	1	348
VFRCOBWW3	Downlights	1	245	WSM16A	Outdoor Wall Lights & Bollards	1	309
VFRCW	Downlights	1	245	WSM16BC	Outdoor Wall Lights & Bollards	1	309
VFRDGCIB	Downlights	1	228	WSM16W	Outdoor Wall Lights & Bollards	1	309
VFRDGICC	Downlights	1	228	WSS8A	Outdoor Wall Lights & Bollards	1	309
VFRDGICCBR	Downlights	1	228	WSS8BC	Outdoor Wall Lights & Bollards	1	309
VFRDGICW	Downlights	1	228	WSS8W	Outdoor Wall Lights & Bollards	1	309
VFRIC8CW	Downlights	1	240	WW15C	Commercial Downlights	1	385

AWARD-WINNING CUSTOMER SERVICE



QUOTES WITHIN
1 HOUR



SAME DAY COLLECTION
FROM OUR WAREHOUSE



5PM CUT OFF NEXT DAY
DELIVERY (MON-THU)
(3PM ON FRIDAYS)



DELIVER DIRECT TO
YOUR CUSTOMERS
WITH K-DIRECT

ONLINE FEATURES



LIVE CHAT



LIVE STOCK
AVAILABILITY



MANAGE AND
TRACK ORDERS



CSV PRODUCT
DATA DOWNLOAD

ABOUT US



ESTABLISHED IN 1998



3000+ PRODUCTS
IN STOCK



AVAILABLE AT ALL
MAJOR WHOLESALERS



COMMITTED TO A
BRIGHTER FUTURE

OFFICE HOURS:

Mon-Thu: 8am to 5.30pm
Fri: 8am to 5pm
Closed on weekends

Tel: 01582 88 77 60

Enquiries: sales@mlaccessories.co.uk

Orders: orders@mlaccessories.co.uk

www.mlaccessories.co.uk

“committed to
a brighter future”

01582 88 77 60
www.mlaccessories.co.uk

